



10-423/10-623 Generative AI

Machine Learning Department
School of Computer Science
Carnegie Mellon University

Parameter Efficient Fine-Tuning

Matt Gormley & Pat Virtue

Lecture 10

Feb. 17, 2025

Reminders

- **Homework 2: Generative Models of Images**
 - **Out: Mon, Feb 10**
 - **Due: Sat, Feb 22 at 11:59pm**

PARAMETER EFFICIENT FINE-TUNING

Few-shot Learning with LLMs

Suppose you have...

- a dataset $D = \{(x_i, y_i)\}_{i=1}^N$ and N is rather small (i.e. few-shot setting)
- a very large (billions of parameters) pre-trained language model

There are two ways to “learn”

Option A: Supervised fine-tuning

- **Definition:** fine-tune the LLM on the training data using...
 - a standard supervised objective
 - backpropagation to compute gradients
 - your favorite optimizer (e.g. Adam)
- **Pro:** fits into the standard ML recipe
- **Pro:** still works if N is large
- **Con:** backpropagation requires $\sim 3x$ the memory and computation time as the forward computation
- **Con:** you might not have access to the model weights at all (e.g. because the model is proprietary)

Option B: In-context learning

- **Definition:**
 1. feed training examples to the LLM as a prompt
 2. allow the LLM to infer patterns in the training examples during inference (i.e. decoding)
 3. take the output of the LLM following the prompt as its prediction
- **Pro:** no backpropagation required and only one pass through the training data
- **Pro:** does not require model weights, only API access
- **Con:** for Transformers, a prompt (of length N) requires $O(N^2)$ time/space
- **Con:** the prompt might not fit into max context of a Transformer LM

Few-shot Learning with LLMs

Suppose you have...

- a dataset $D = \{(x_i, y_i)\}_{i=1}^N$ and N is rather small (i.e. few-shot setting)
- a very large (billions of parameters) pre-trained language model

There are two ways to “learn”

Option A: Supervised fine-tuning

- **Definition:** fine-tune the LLM on the training data using...
 - a standard supervised objective
 - backpropagation to compute gradients
 - your favorite optimizer (e.g. Adam)
- **Pro:** fits into the standard ML recipe
- **Pro:** still works if N is large
- **Con:** backpropagation requires $\sim 3x$ the memory and computation time as the forward computation
- **Con:** you might not have access to the model weights at all (e.g. because the model is proprietary)



Option B: In-context learning

In this section, we consider the question:

How can we do supervised fine-tuning of a very large foundation model more efficiently?

- **Pro:** no backpropagation required and only one pass through the training data
- **Pro:** does not require model weights, only API access
- **Con:** for Transformers, a prompt (of length N) requires $O(N^2)$ time/space
- **Con:** the prompt might not fit into max context of a Transformer LM

Fine-Tuning vs. In-Context Learning

- Why would we ever bother with fine-tuning if it's so inefficient?
- Because, even for very large LMs, fine-tuning often beats in-context learning

Method	MNLI-m (Val. Acc./%)	RTE (Val. Acc./%)
GPT-3 Few-Shot	40.6	69.0
GPT-3 Fine-Tuned	89.5	85.4

Question:

Why did fine-tuning of GPT-3 do so much better on these two tasks than few-shot learning?

Answer:

- *Few-shot details:* GPT-3's context length is only 2048 tokens. So the MNLI-m setting above only uses 6 few-shot examples in total.
- *Fine-tuned details:* MNLI-m has 393,000 training examples and GPT-3 is fine-tuned for 2 epochs.

Fine-Tuning vs. In-Context Learning

- Why would we ever bother with fine-tuning if it's so inefficient?
- Because, even for very large LMs, fine-tuning often beats in-context learning
- In a fair comparison of fine-tuning (FT) and in-context learning (ICL), we find that FT outperforms ICL for most model sizes on RTE and MNLI

		FT						
		125M	350M	1.3B	2.7B	6.7B	13B	30B
ICL	125M	-0.00	0.01	0.02	0.03	0.12	0.14	0.09
	350M	-0.00	0.01	0.02	0.03	0.12	0.14	0.09
	1.3B	-0.00	0.01	0.02	0.03	0.12	0.14	0.09
	2.7B	-0.00	0.01	0.02	0.03	0.12	0.14	0.09
	6.7B	-0.00	0.01	0.02	0.03	0.12	0.14	0.09
	13B	-0.04	-0.02	-0.01	-0.00	0.09	0.11	0.05
	30B	-0.11	-0.09	-0.08	-0.08	0.02	0.03	-0.02

(a) RTE

		FT						
		125M	350M	1.3B	2.7B	6.7B	13B	30B
ICL	125M	-0.00	0.00	0.02	0.01	0.10	0.11	0.07
	350M	-0.00	0.00	0.02	0.01	0.10	0.11	0.07
	1.3B	-0.01	-0.00	0.01	0.01	0.10	0.11	0.07
	2.7B	-0.01	-0.00	0.01	0.01	0.09	0.10	0.07
	6.7B	-0.01	-0.01	0.01	0.00	0.09	0.10	0.06
	13B	-0.03	-0.03	-0.02	-0.02	0.07	0.08	0.04
	30B	-0.07	-0.07	-0.05	-0.06	0.03	0.04	0.00

(b) MNLI

Table 1: Difference between average **out-of-domain performance** of ICL and FT on RTE (a) and MNLI (b) across model sizes. We use 16 examples and 10 random seeds for both approaches. For ICL, we use the `gpt-3` pattern. For FT, we use pattern-based fine-tuning (PBFT) and select checkpoints according to in-domain performance. We perform a Welch's t-test and color cells according to whether: **ICL performs significantly better than FT**, **FT performs significantly better than ICL**. For cells without color, there is no significant difference.

Fine-Tuning vs. In-Context Learning

- Why would we ever bother with fine-tuning if it's so inefficient?
- Because, even for very large LMs, fine-tuning often beats in-context learning
- In a fair comparison of fine-tuning (FT) and in-context learning (ICL), we find that FT outperforms ICL for most model sizes on RTE and MNLI

		FT						
		125M	350M	1.3B	2.7B	6.7B	13B	30B
ICL	125M	-0.00	0.01	0.02	0.03	0.12	0.14	0.09
	350M	-0.00	0.01	0.02	0.03	0.12	0.14	0.09
	1.3B	-0.00	0.01	0.02	0.03	0.12	0.14	0.09
	2.7B	-0.00	0.01	0.02	0.03	0.12	0.14	0.09
	6.7B	-0.00	0.01	0.02	0.03	0.12	0.14	0.09
	13B	-0.04	-0.02	-0.01	-0.00	0.09	0.11	0.05
	30B	-0.11	-0.09	-0.08	-0.08	0.02	0.03	-0.02

(a) RTE

		FT						
		125M	350M	1.3B	2.7B	6.7B	13B	30B
ICL	125M	-0.00	0.00	0.02	0.01	0.10	0.11	0.07
	350M	-0.00	0.00	0.02	0.01	0.10	0.11	0.07
	1.3B	-0.01	-0.00	0.01	0.01	0.10	0.11	0.07
	2.7B	-0.01	-0.00	0.01	0.01	0.09	0.10	0.07
	6.7B	-0.01	-0.01	0.01	0.00	0.09	0.10	0.06
	13B	-0.03	-0.03	-0.02	-0.02	0.07	0.08	0.04
	30B	-0.07	-0.07	-0.05	-0.06	0.03	0.04	0.00

(b) MNLI

At least this was the general wisdom in 2023.

We might have a different story to tell since 2024.
(See Lecture 19)

Table 1: Difference between average **out-of-domain performance** of ICL and FT on RTE (a) and MNLI (b) for different model sizes. We use 16 examples and 10 random seeds for both approaches. For ICL, we use the standard in-context learning approach. For FT, we use pattern-based fine-tuning (PBFT) and select checkpoints according to in-domain performance. We perform a Welch's t-test and color cells according to whether: **ICL performs significantly better than FT** (red), **FT performs significantly better than ICL** (blue), or there is no significant difference (white).

Parameter Efficient Fine-Tuning

- **Goal:** perform fine-tuning of fewer parameters, but achieve performance on a downstream task that is comparable to fine-tuning of all parameters
- **Various approaches:**
 - **Subset:** Pick a subset of the parameters and fine-tune only those (e.g. only the top K layers of a K+L layer deep neural network)
 - **Adapters:** add additional layers that have few parameters and tune only the parameters of those layers, keeping all others fixed
 - **Prefix Tuning:** for a Transformer LM, pretend as if there exist many tokens that came before your sequence and tune the keys/values corresponding to those tokens
 - **LoRA:** learn a small delta for the each of the parameter matrices with the delta chosen to be low rank

Fine-Tuning the Top Layers Only

- Simple baseline for PEFT:
 - keep all parameters fixed except for the top K layers
 - gradients only need to flow through K layers instead of K+L total layers
 - reduced memory usage b/c we don't need to store the adjoints (gradient of the loss with respect to each parameter) for the full computation graph
- Can easily be applied to most deep neural networks

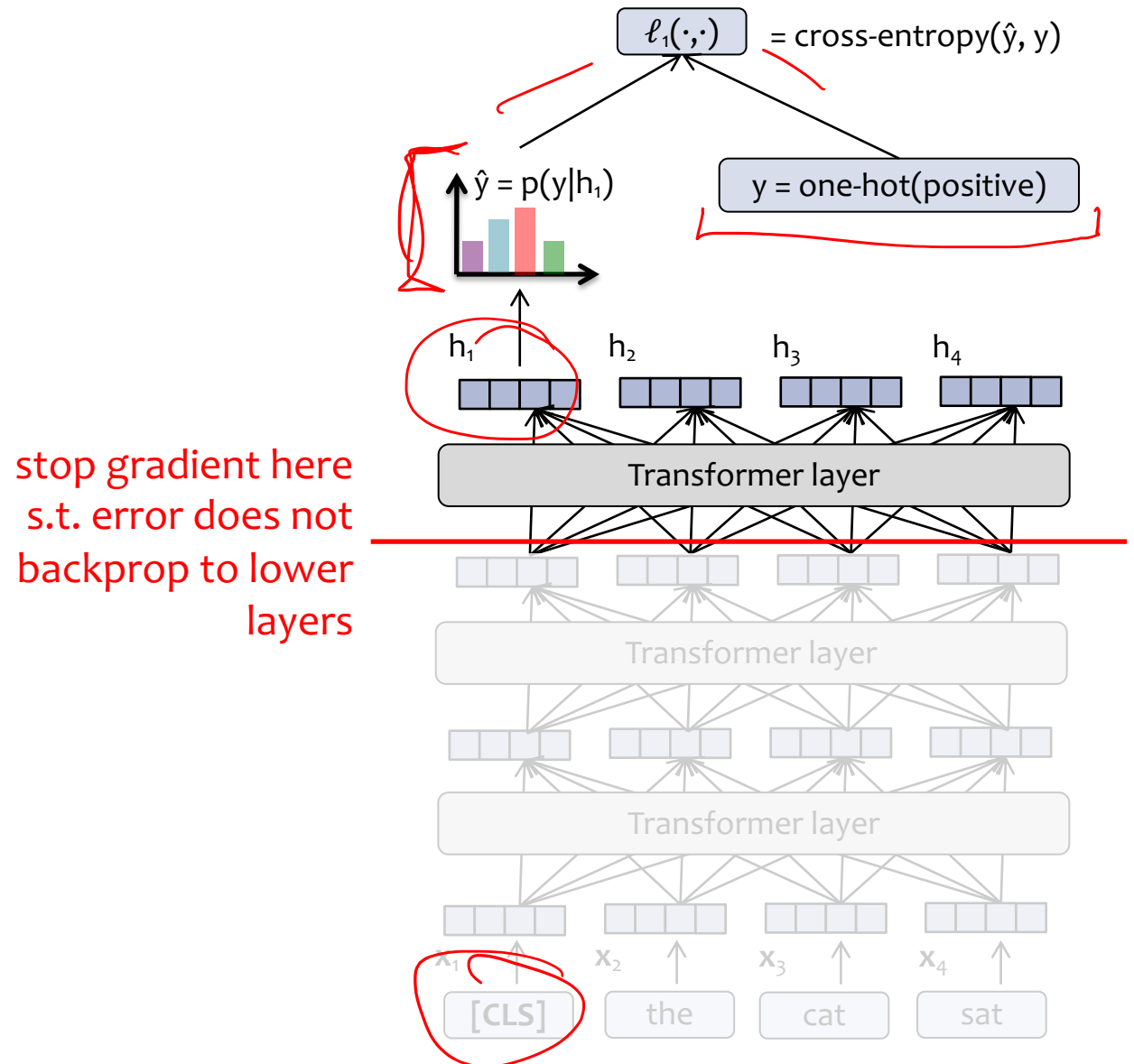

Fine-Tuning the Top Layers Only

- Simple baseline for PEFT:
 - keep all parameters fixed except for the top K layers
 - gradients only need to flow through K layers instead of K+L total layers
 - reduced memory usage b/c we don't need to store the adjoints (gradient of the loss with respect to each parameter) for the full

Question:

Why does this work at all?

Shouldn't it do a poor job fitting the underlying trends in our data?

stop gradient here
s.t. error does not
backprop to lower
layers

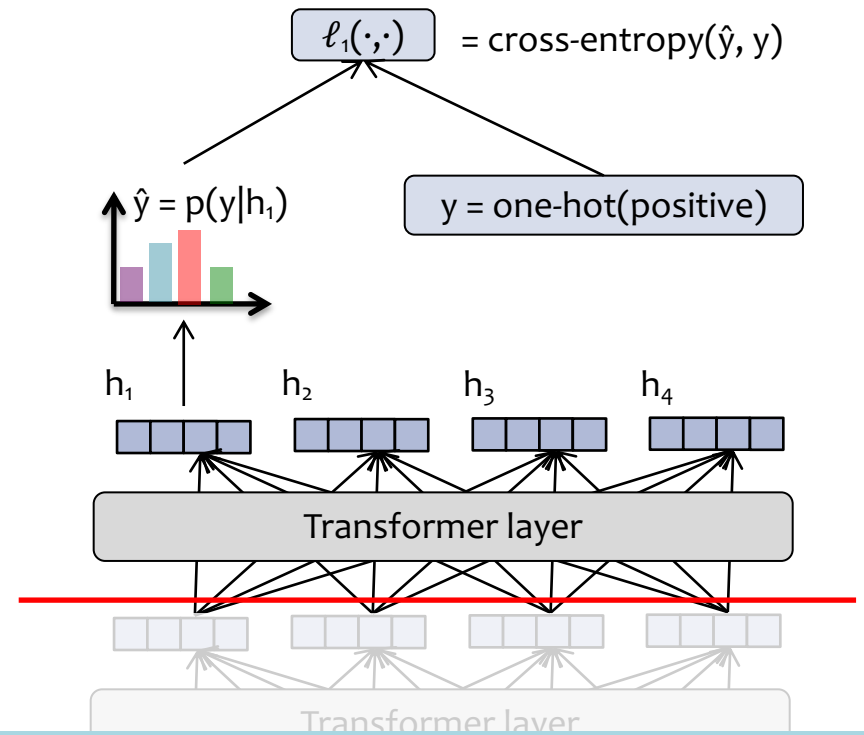

Answer:

ADAPTERS

Decoder-only Transformer

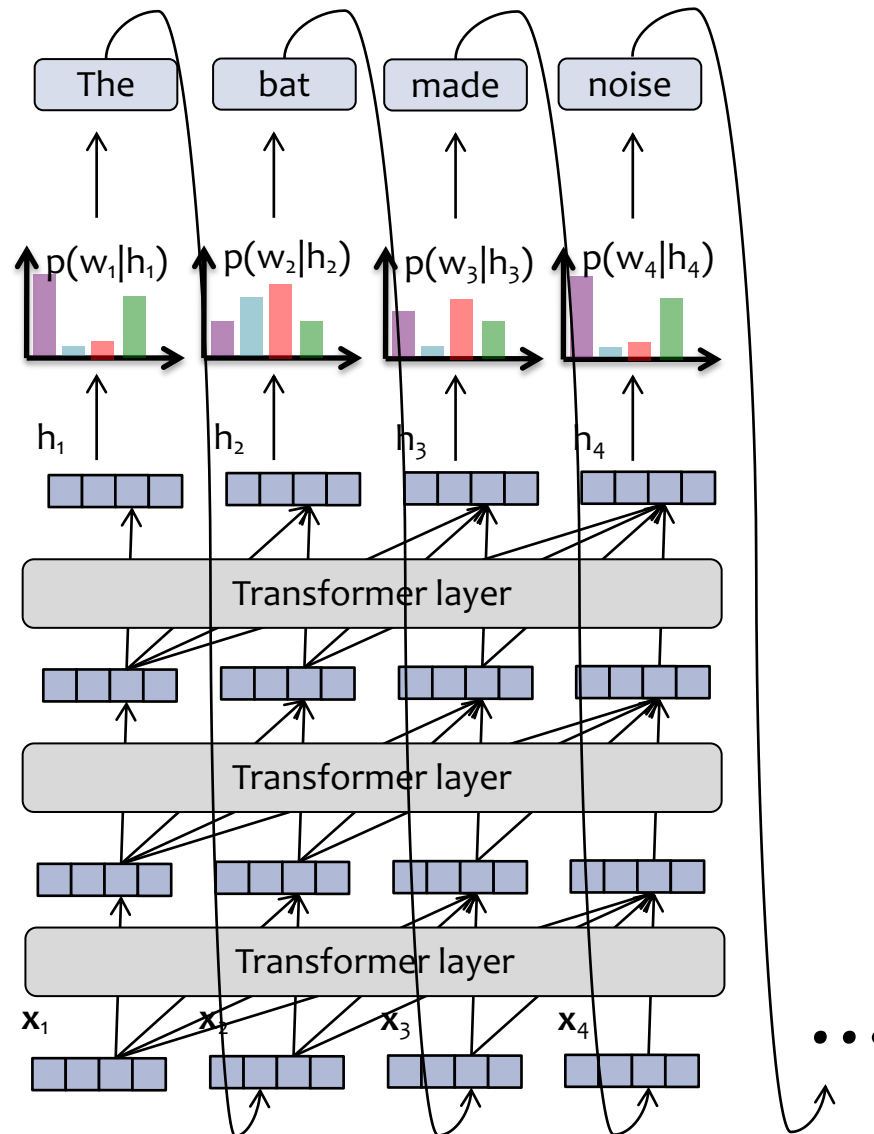

Each layer of a Transformer LM consists of several **sublayers**:

1. attention
2. feed-forward neural network
3. layer normalization
4. residual connections

Each hidden vector looks back at the hidden vectors of the **current and previous timesteps in the previous layer**.

The language model part is just like an RNN-LM.

Encoder-only Transformer

BERT popularized this encoder-only Transformer architecture and style of pretraining

MLM Pretraining:

- Rather than trying to predict the next word from the previous ones...
- ...mask out a word (or a few words) and predict the missing words from the remaining ones

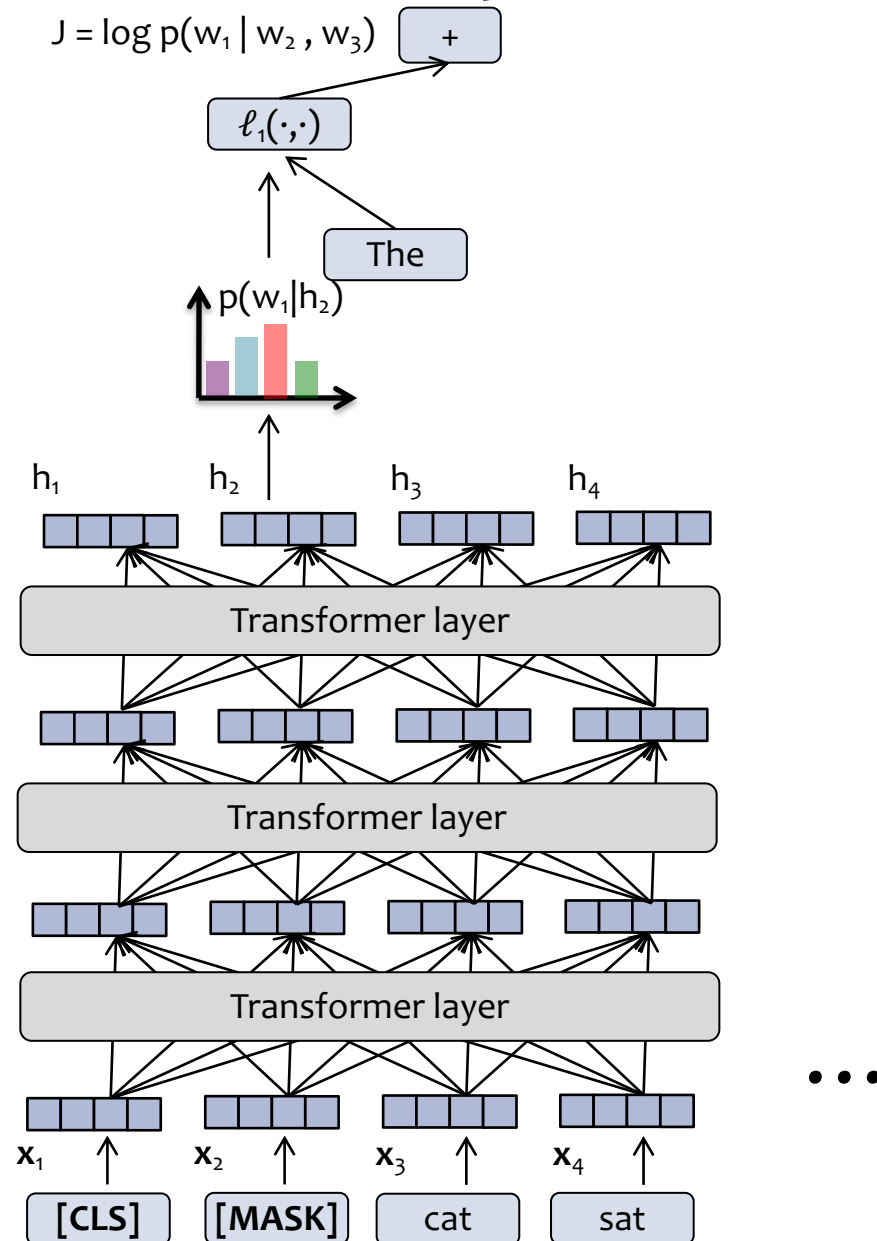

Each layer of an encoder-only Transformer consists of several **sublayers**:

1. non-causal attention
2. feed-forward neural network
3. layer normalization
4. residual connections

Each hidden vector looks at the the hidden vectors of **all timesteps in the previous layer**.

The distribution over words is used for **masked language model (MLM) pre-training** (cf. BERT)

...

Adapters Module

- An adapter layer is simply a feed-forward neural network with one hidden layer, and a residual connection
- For input dimension, d , the adapter layer also has output dimension d , but bottlenecks to a lower dimension r in the middle

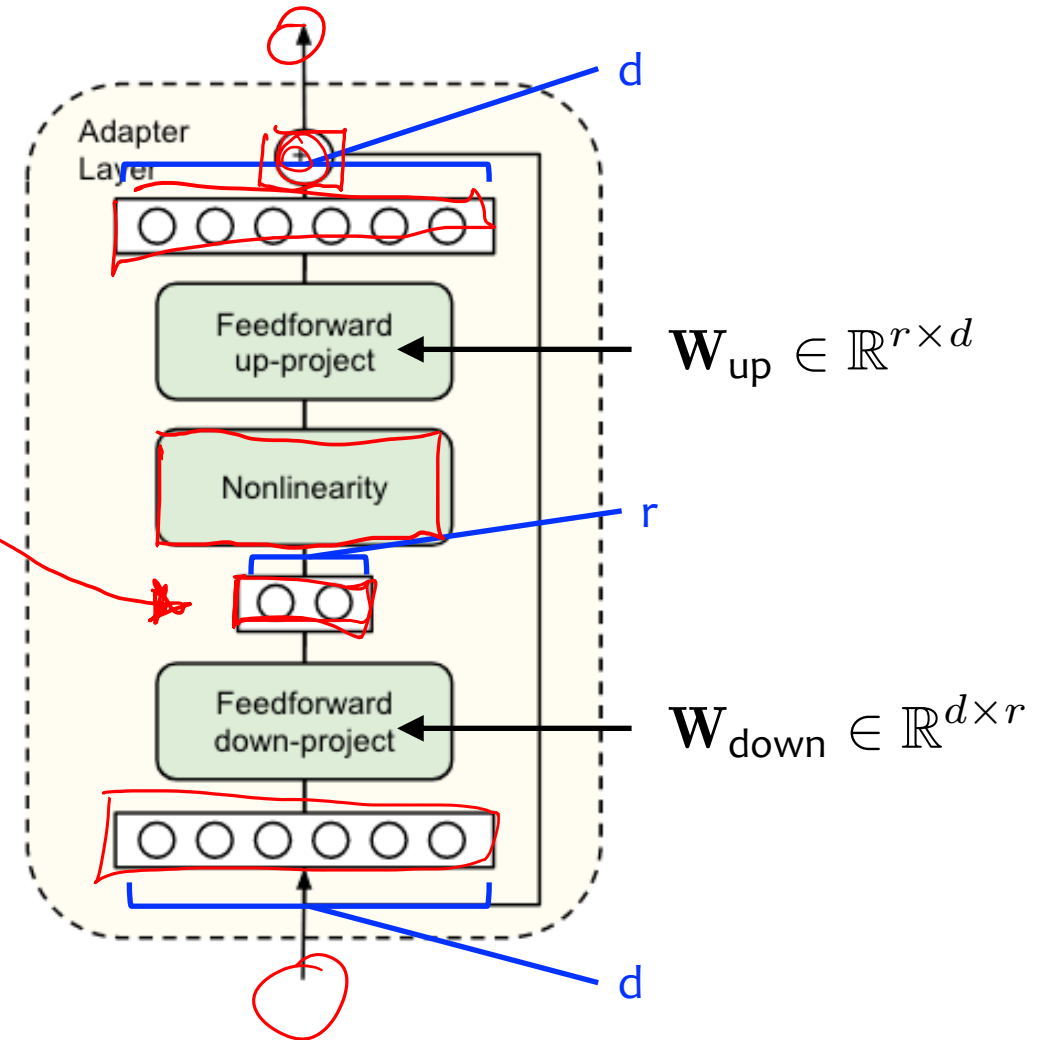

Adapters for Transformer

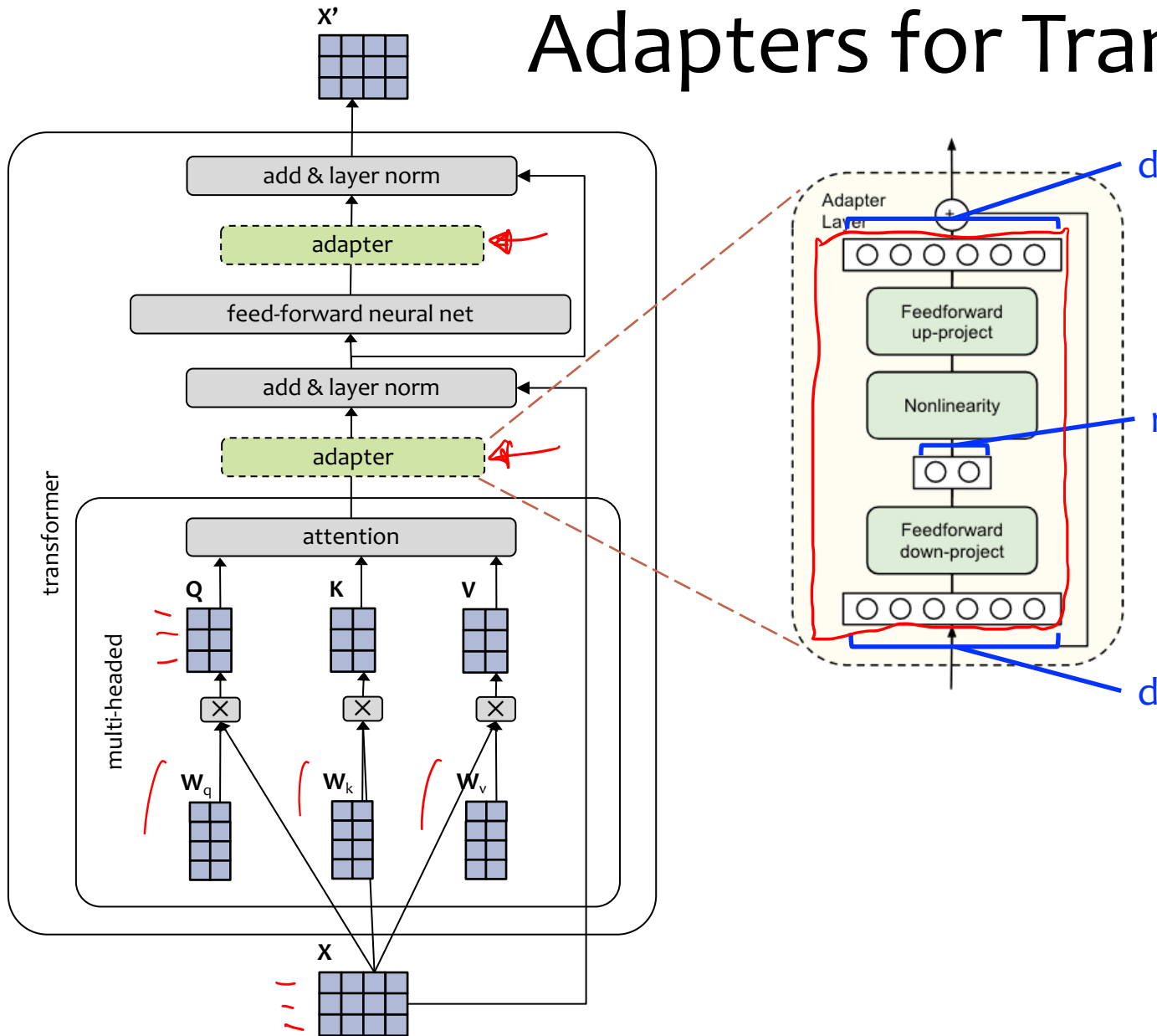

- In practice, r is chosen s.t. $r \ll d$ and the adapter layers contain only 0.5% – 8% of the total parameters
- When added to a deep neural network (e.g. Transformer) all the other parameters of the pretrained model are kept fixed, and only the adapter layer parameters are fine-tuned
- Interesting: it works even though the grey modules are kept fixed!

Adapter Results

- **Pretrained Model:** BERT-Large
- **Baseline Method:** fine-tune only the top K layers of BERT-Large
- Adapters achieve nearly the performance (i.e. 0% delta) of full fine-tuning but with substantially fewer parameters
- Sometimes adapters even outperform full fine-tuning

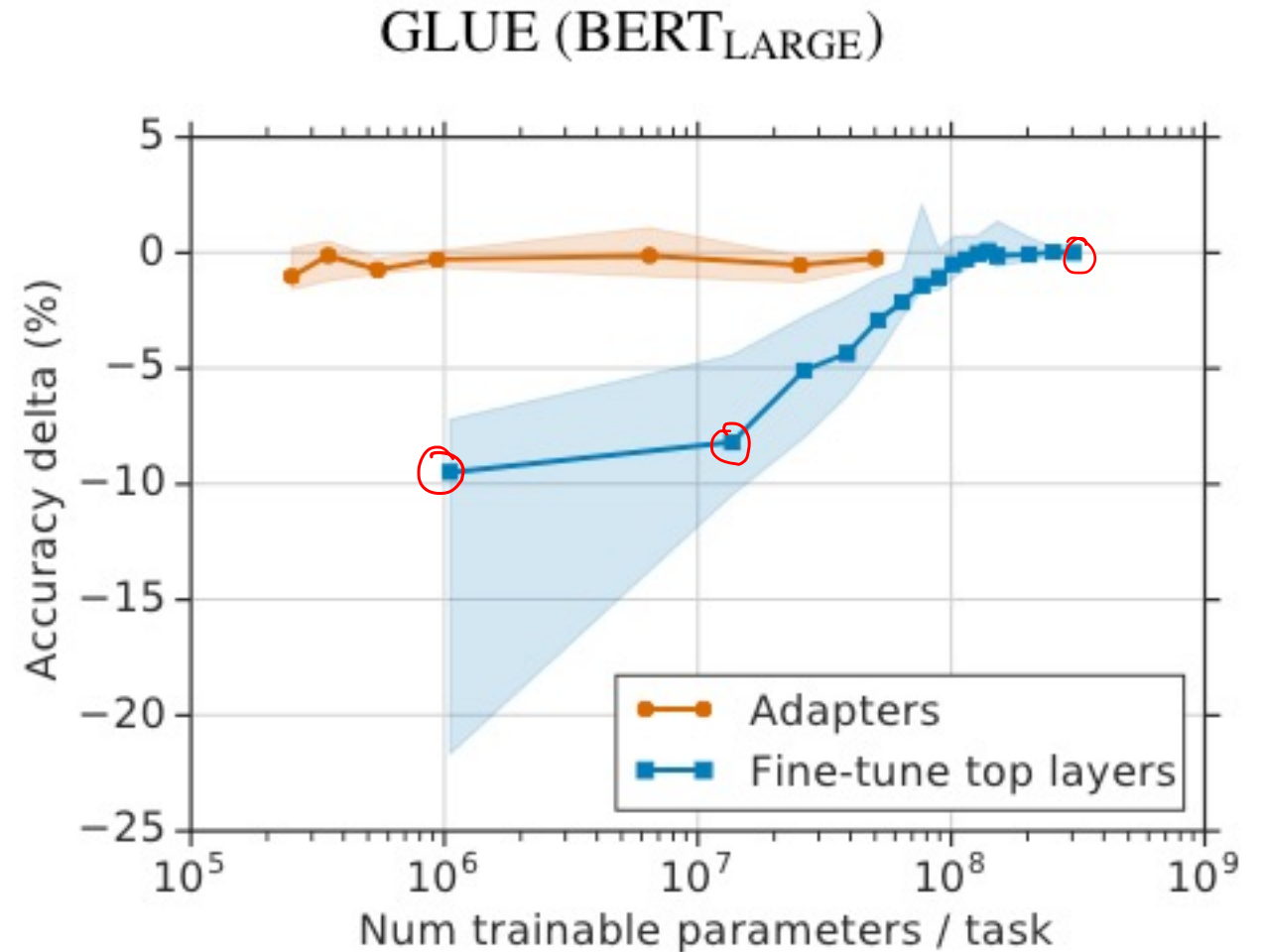

Adapter Results

- **Pretrained Model:** BERT-Large
- **Baseline Method:** fine-tune only the top K layers of BERT-Large
- Adapters achieve nearly the performance (i.e. 0% delta) of full fine-tuning but with substantially fewer parameters
- Sometimes adapters even outperform full fine-tuning

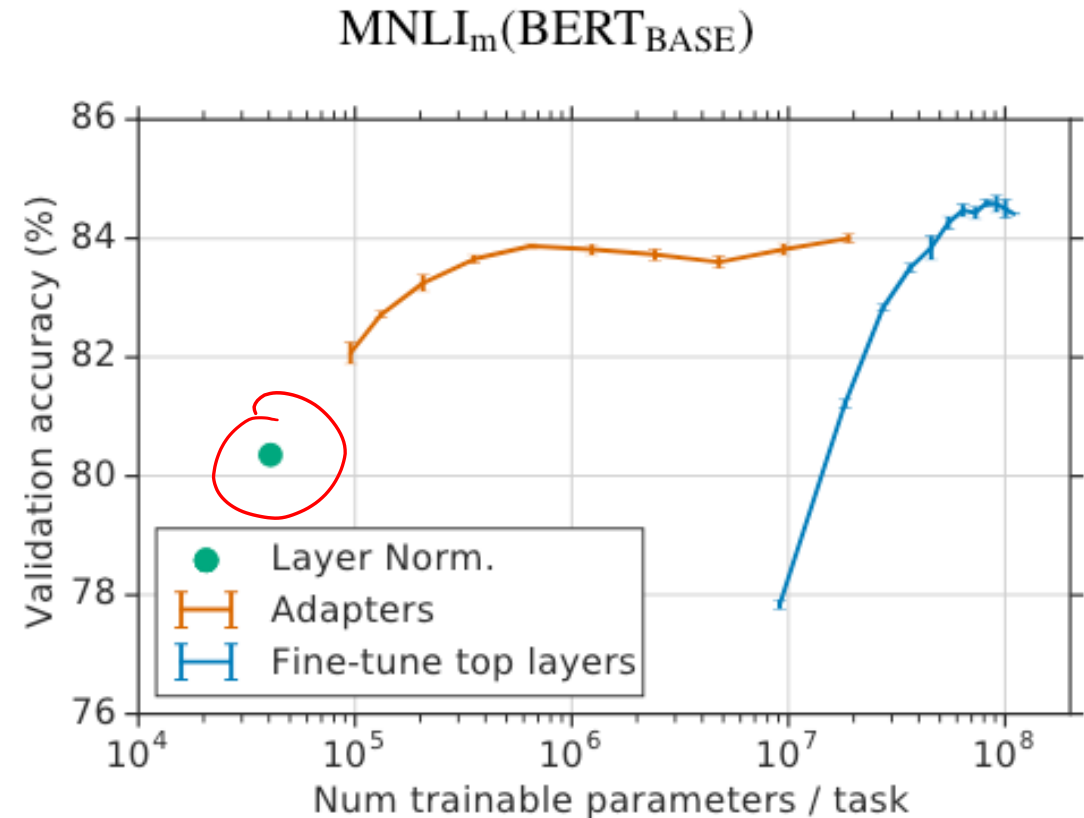

Adapter Results

- **Pretrained Model:** BERT-Large
- **Baseline Method:** fine-tune only the top K layers of BERT-Large
- Adapters achieve nearly the performance (i.e. 0% delta) of full fine-tuning but with substantially fewer parameters
- Sometimes adapters even outperform full fine-tuning

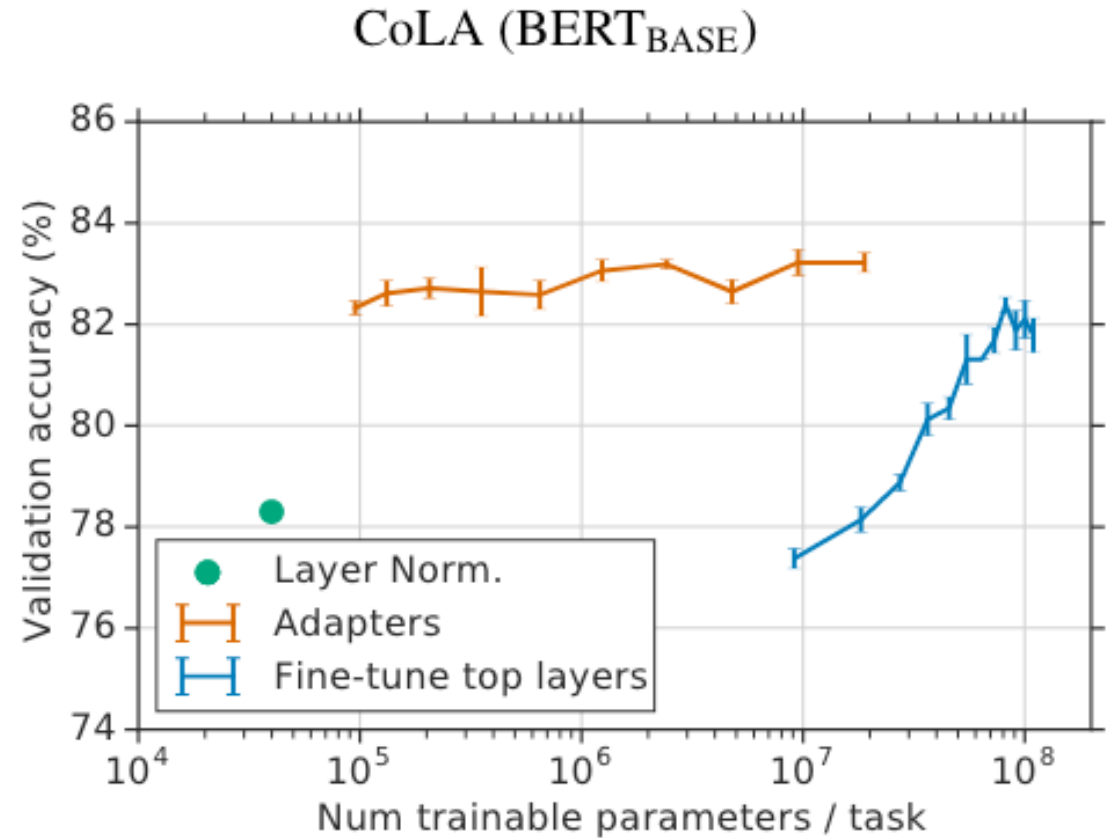

~~PROMPT TUNING~~ & PREFIX TUNING

Prefix Tuning

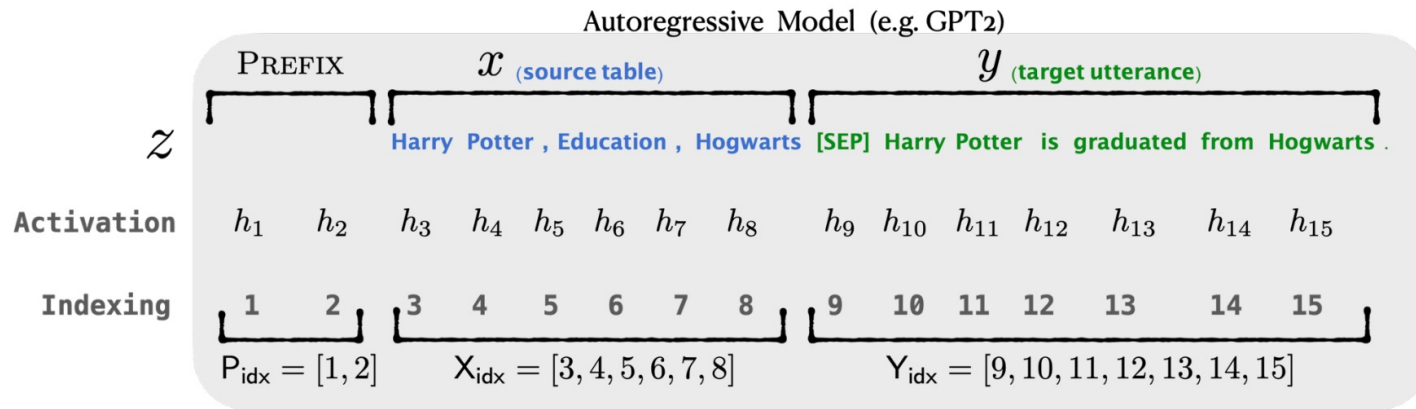

For a Transformer, we will say the *activation* of token i in some layer/head is given by its key/value vectors:

$$\mathbf{h}_i = [\mathbf{k}_i^T, \mathbf{v}_i^T]^T$$

1. inject (dummy) prefix tokens, indexed by P_{idx} , before the real tokens
2. represent i 'th prefix token's activation by trainable parameters:

$$\mathbf{h}_i = \mathbf{P}_\theta[i, :]$$

3. for each i let $\mathbf{P}_\theta[i, :] = \text{MLP}(\mathbf{Q}_\theta[i, :])$ because having \mathbf{Q}_θ of lower dimension than \mathbf{P}_θ improves stability during training
4. during training, keep all Transformer parameters fixed, except for θ

Prefix Tuning

Also works for encoder-decoder Transformer models, but we inject prefix tokens before both the source tokens x and the target tokens y

1. inject (dummy) prefix tokens, indexed by P_{idx} , before the real tokens
2. represent i 'th prefix token's activation by trainable parameters:

$$\mathbf{h}_i = \mathbf{P}_\theta[i, :]$$
3. for each i let

$$\mathbf{P}_\theta[i, :] = \text{MLP}(\mathbf{Q}_\theta[i, :])$$

because having \mathbf{Q}_θ of lower dimension than \mathbf{P}_θ improves stability during training during training, keep all Transformer parameters fixed, except for θ

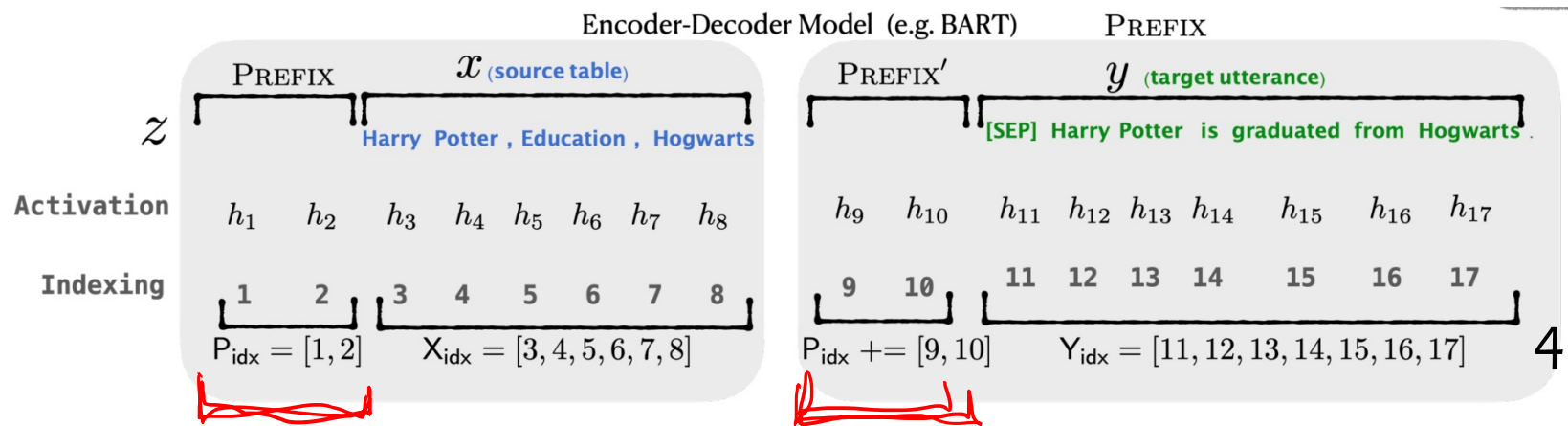

Prefix Tuning

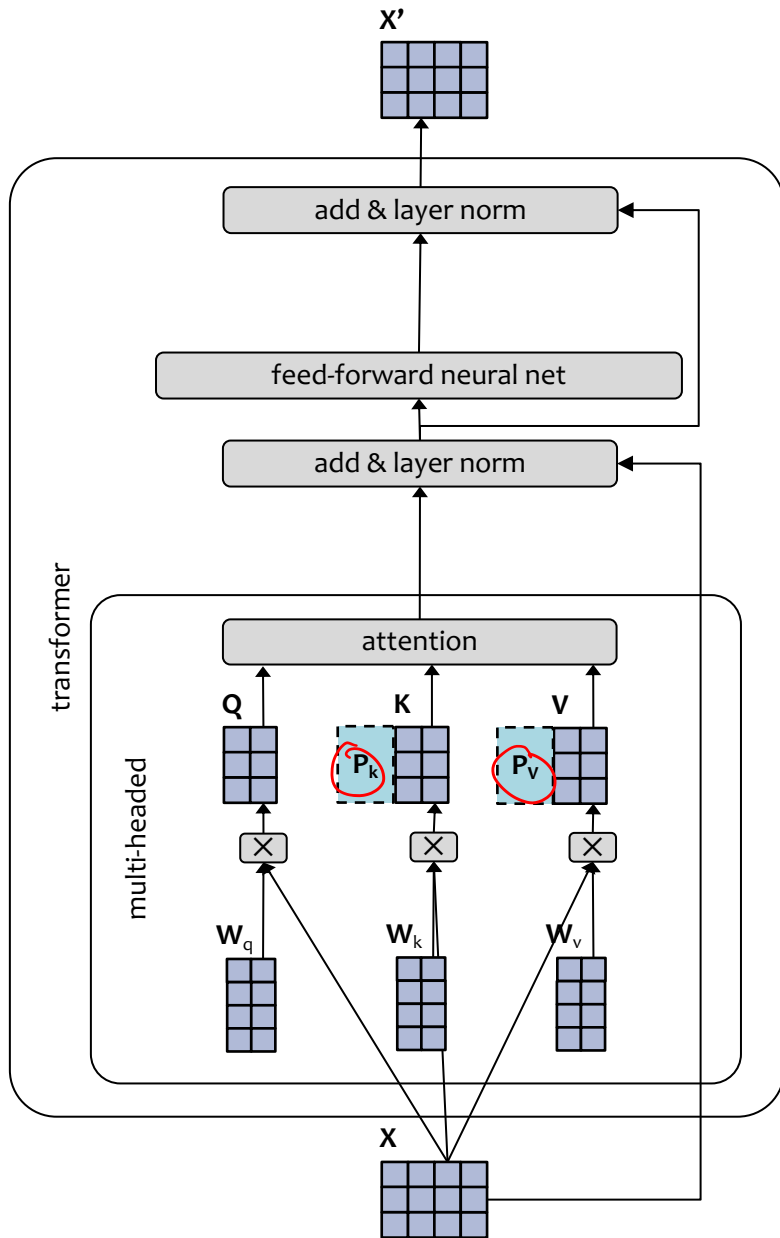

softmax $\left(\frac{QK^T}{\sqrt{d_k}} \right) V$

not square anymore

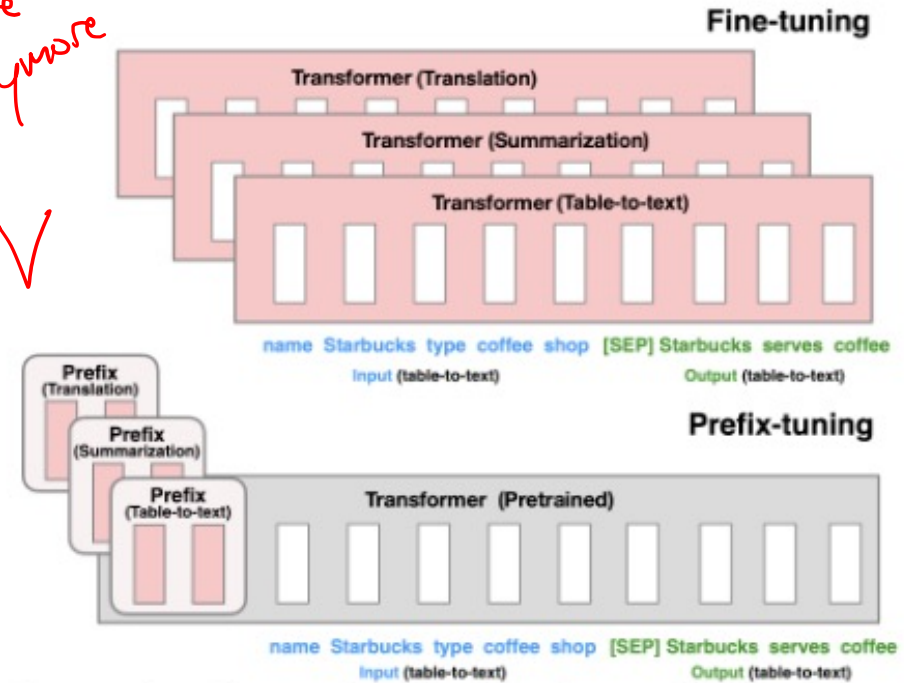

Figure 1: Fine-tuning (top) updates all Transformer parameters (the red Transformer box) and requires storing a full model copy for each task. We propose prefix-tuning (bottom), which freezes the Transformer parameters and only optimizes the prefix (the red prefix blocks). Consequently, we only need to store the prefix for each task, making prefix-tuning modular and space-efficient. Note that each vertical block denote transformer activations at one time step.

LOW-RANK ADAPTATION (LORA)

How large are LLMs?

Comparison of some recent **large language models** (LLMs)

Model	Creators	Year of release	Training Data (# tokens)	Model Size (# parameters)
GPT-2	OpenAI	2019	~10 billion (40Gb)	1.5 billion
GPT-3 (cf. ChatGPT)	OpenAI	2020	300 billion	175 billion
PaLM	Google	2022	780 billion	540 billion
Chinchilla	DeepMind	2022	1.4 trillion	70 billion
LaMDA (cf. Bard)	Google	2022	1.56 trillion	137 billion
LLaMA	Meta	2023	1.4 trillion	65 billion
LLaMA-2	Meta	2023	2 trillion	70 billion
GPT-4	OpenAI	2023	?	? (1.76 trillion)
Gemini (Ultra)	Google	2023	?	? (1.5 trillion)
LLaMA-3	Meta	2024	15 trillion	405 billion

How large are the linear layers in a Transformer?

Model Name	n_{params}	n_{layers}	d_{model}	n_{heads}	d_{head}	Batch Size	Learning Rate
GPT-3 Small	125M	12	768	12	64	0.5M	6.0×10^{-4}
GPT-3 Medium	350M	24	1024	16	64	0.5M	3.0×10^{-4}
GPT-3 Large	760M	24	1536	16	96	0.5M	2.5×10^{-4}
GPT-3 XL	1.3B	24	2048	24	128	1M	2.0×10^{-4}
GPT-3 2.7B	2.7B	32	2560	32	80	1M	1.6×10^{-4}
GPT-3 6.7B	6.7B	32	4096	32	128	2M	1.2×10^{-4}
GPT-3 13B	13.0B	40	5140	40	128	2M	1.0×10^{-4}
GPT-3 175B or "GPT-3"	175.0B	96	12288	96	128	3.2M	0.6×10^{-4}

Table 2.1: Sizes, architectures, and learning hyper-parameters (batch size in tokens and learning rate) of the models which we trained. All models were trained for a total of 300 billion tokens.

Size of linear layer in GPT-3:
12k * 12k

Fine-Tuning LLMs without Regularization

Method	MNLI-m (Val. Acc./%)	RTE (Val. Acc./%)
GPT-3 Few-Shot	40.6	69.0
GPT-3 Fine-Tuned	89.5	85.4

Question:

Why don't LLMs overfit when we fine-tune them without regularization?

Hypothesis:

They are intrinsically low dimensional

Intrinsic Dimensionality

Motivation

- Maybe the number of parameters in a model is **not** a great measure of how many degrees of freedom are needed to successfully learn some problem
- How could we measure the number of degrees of freedom you **really** need?

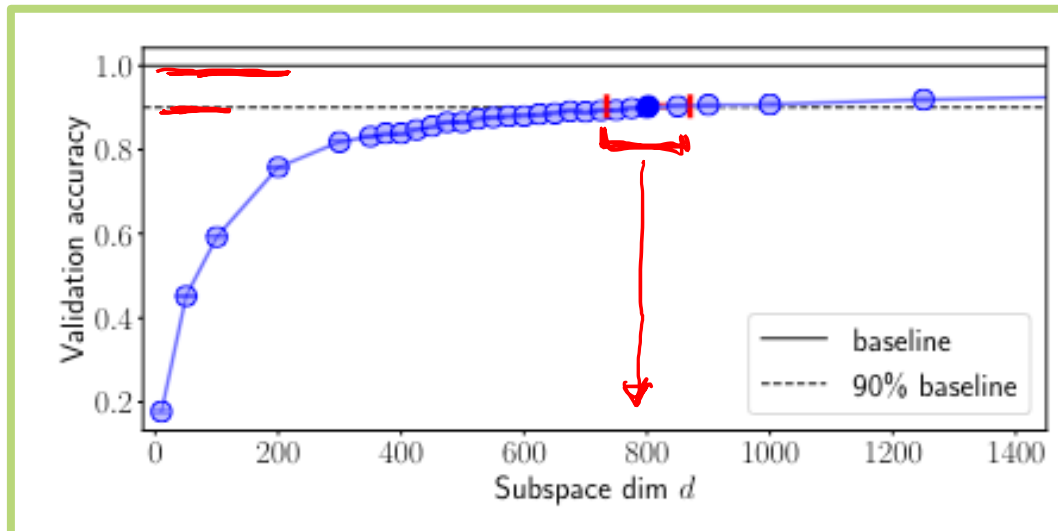

Intrinsic Dimension

Definition from Li et al. (2018):

- Learn a neural network with D parameters in a random lower dimensional subspace, d
- Then repeat, gradually increasing the dimensionality, d
- Let the **intrinsic dimension** be the value of d when good solutions (above 90% threshold of full parameterization) start to appear

For MNIST digit recognition, original neural network has $D=199,210$ parameters but the intrinsic dimension is only $d=750$

Intrinsic Dimensionality

How do we learn in a low dimensional subspace?

$$\theta^{(D)} = \text{concat}(\text{flatten}(\mathbf{W}_1), \text{flatten}(\mathbf{W}_2))$$

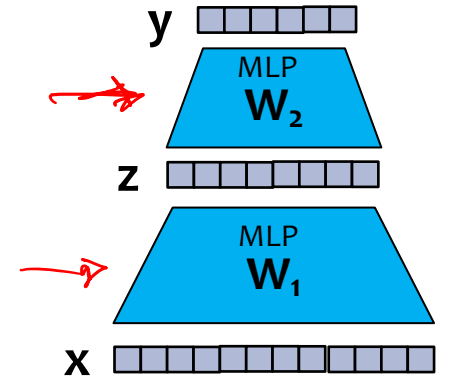

Standard optimization, which we will refer to hereafter as the *direct* method of training, entails evaluating the gradient of a loss with respect to $\theta^{(D)}$ and taking steps directly in the space of $\theta^{(D)}$. To train in a random subspace, we instead define $\theta^{(D)}$ in the following way:

$$\theta^{(D)} = \theta_0^{(D)} + P\theta^{(d)} \quad (2)$$

where P is a randomly generated $D \times d$ projection matrix¹ and $\theta^{(d)}$ is a parameter vector in a generally smaller space \mathbb{R}^d . $\theta_0^{(D)}$ and P are randomly generated and frozen (not trained), so the system has only d degrees of freedom. We initialize $\theta^{(d)}$ to a vector of all zeros, so initially $\theta^{(D)} = \theta_0^{(D)}$.

Intrinsic Dimensionality

- Using similar techniques, Aghajanyan et al. (2020) measure the intrinsic dimension of LLMs
- Empirical results suggest that pre-training finds parameters that have low intrinsic dimensionality
- Number of parameters:
 - BERT-Base: 110 million
 - BERT-Large: 345 million

Model	SAID		DID	
	MRPC	QQP	MRPC	QQP
BERT-Base	1608	8030	1861	9295
BERT-Large	1037	1200	2493	1389
RoBERTa-Base	896	896	1000	1389
RoBERTa-Large	207	774	322	774

Table 1: Estimated d_{90} intrinsic dimension for a set of sentence prediction tasks and common pre-trained models. We present both the *SAID* and *DID* methods.

LoRA

- **Motivation #1:**
“We take inspiration from Li et al. (2018a); Aghajanyan et al. (2020) which show that the learned over-parametrized models in fact reside on a low intrinsic dimension.”
- **Motivation #2:**
Directly optimizing the prompt, as in prefix tuning, leads to non-monotonic changes in performance as the number of parameters increases (we want more parameters to mean better performance!)
- **Motivation #3:**
Adapters and related methods introduce inference latency at test time that is non-trivial!

Batch Size	32	16	1
Sequence Length	512	256	128
$ \Theta $	0.5M	11M	11M
Fine-Tune/LoRA	1449.4±0.8	338.0±0.6	19.8±2.7
Adapter ^L	1482.0±1.0 (+2.2%)	354.8±0.5 (+5.0%)	23.9±2.1 (+20.7%)
Adapter ^H	1492.2±1.0 (+3.0%)	366.3±0.5 (+8.4%)	25.8±2.2 (+30.3%)

Table 1: Inference latency of a single forward pass in GPT-2 medium measured in milliseconds, averaged over 100 trials. We use an NVIDIA Quadro RTX8000. “ $|\Theta|$ ” denotes the number of trainable parameters in adapter layers. Adapter^L and Adapter^H are two variants of adapter tuning, which we describe in [Section 5.1](#). The inference latency introduced by adapter layers can be significant in an online, short-sequence-length scenario. See the full study in [Appendix B](#).

LoRA

Key Idea

- Keep the original pretrained parameters \mathbf{W}_0 fixed during fine-tuning
- Learn an additive modification to those parameters $\Delta\mathbf{W}$
- Define $\Delta\mathbf{W}$ via a low rank decomposition:

$$\Delta\mathbf{W} = \mathbf{BA}$$

where \mathbf{BA} has rank r , which is **much less** than the input dimension k or the output dimension d

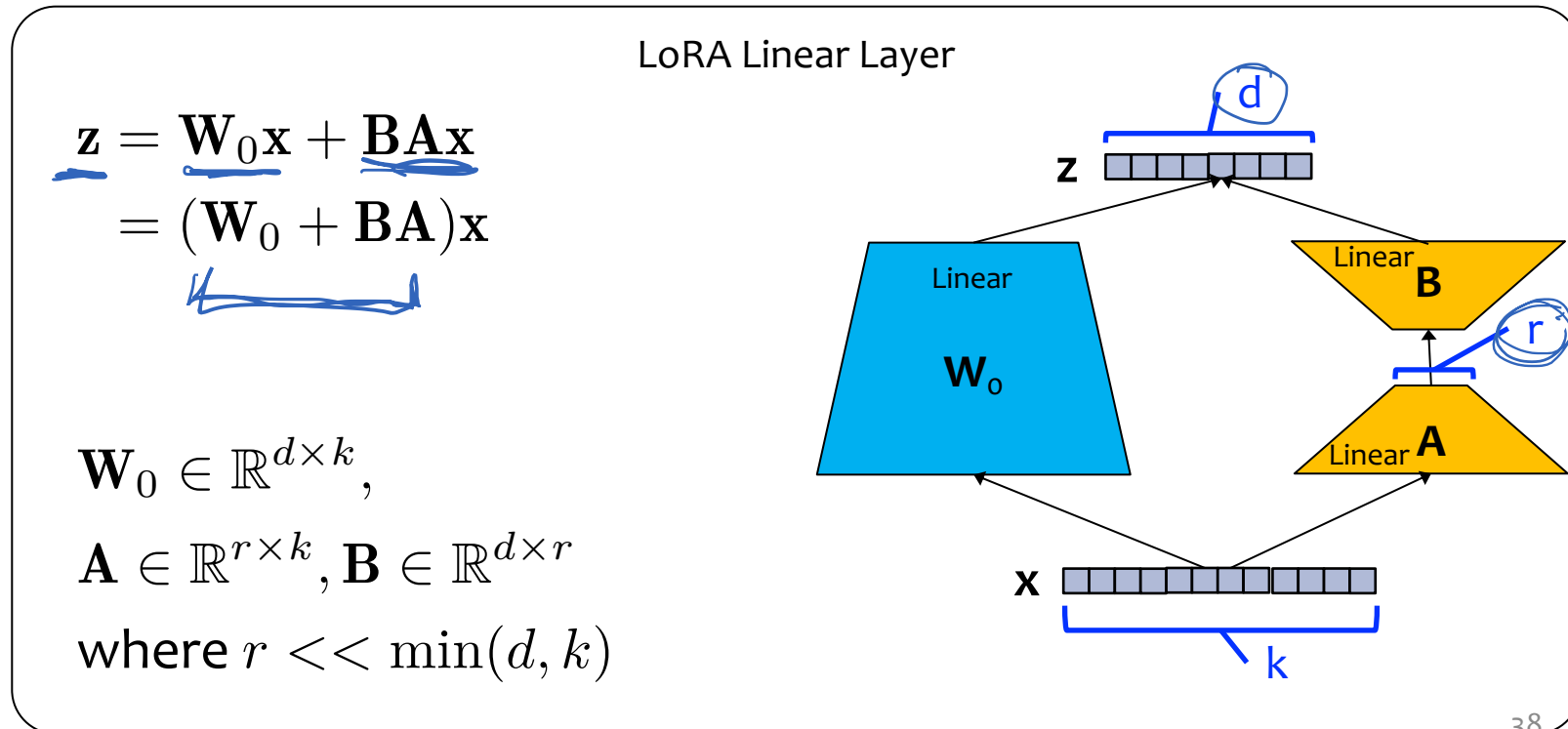
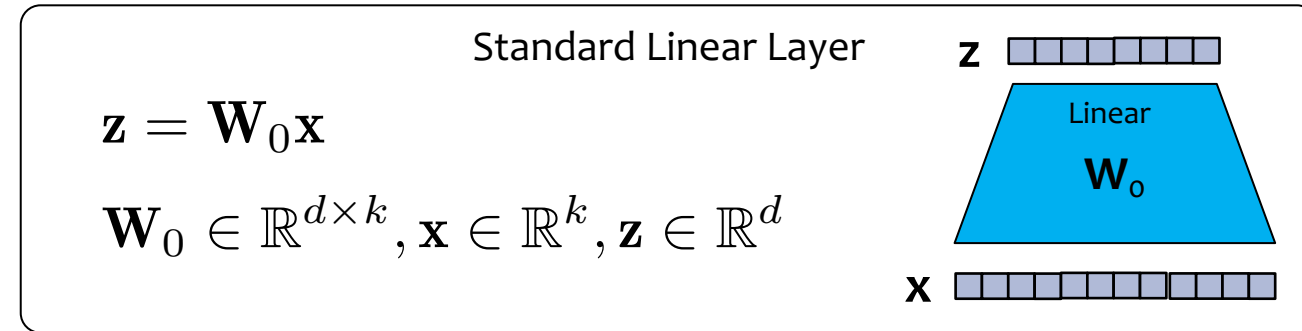

LoRA

Initialization

- We initialize the trainable parameters:

$$A_{ij} \sim \mathcal{N}(0, \sigma^2), \forall i, j$$

$$\mathbf{B} = 0$$

- This ensures that, at the start of fine tuning, the parameters have their pretrained values:

$$\Delta \mathbf{W} = \mathbf{BA} = 0$$

$$\mathbf{W}_0 + \mathbf{BA} = \mathbf{W}_0$$

$$\mathbf{z} = \mathbf{W}_0 \mathbf{x}$$

$$\mathbf{W}_0 \in \mathbb{R}^{d \times k}, \mathbf{x} \in \mathbb{R}^k, \mathbf{z} \in \mathbb{R}^d$$

Standard Linear Layer

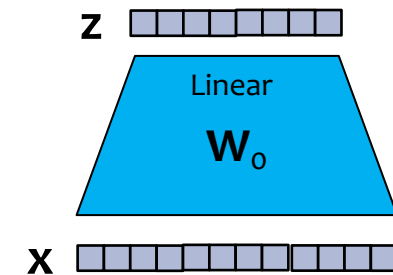

$$\mathbf{z} = \mathbf{W}_0 \mathbf{x} + \mathbf{BA} \mathbf{x}$$
$$= (\mathbf{W}_0 + \mathbf{BA}) \mathbf{x}$$

$$\mathbf{W}_0 \in \mathbb{R}^{d \times k},$$

$$\mathbf{A} \in \mathbb{R}^{r \times k}, \mathbf{B} \in \mathbb{R}^{d \times r}$$

where $r \ll \min(d, k)$

LoRA Linear Layer

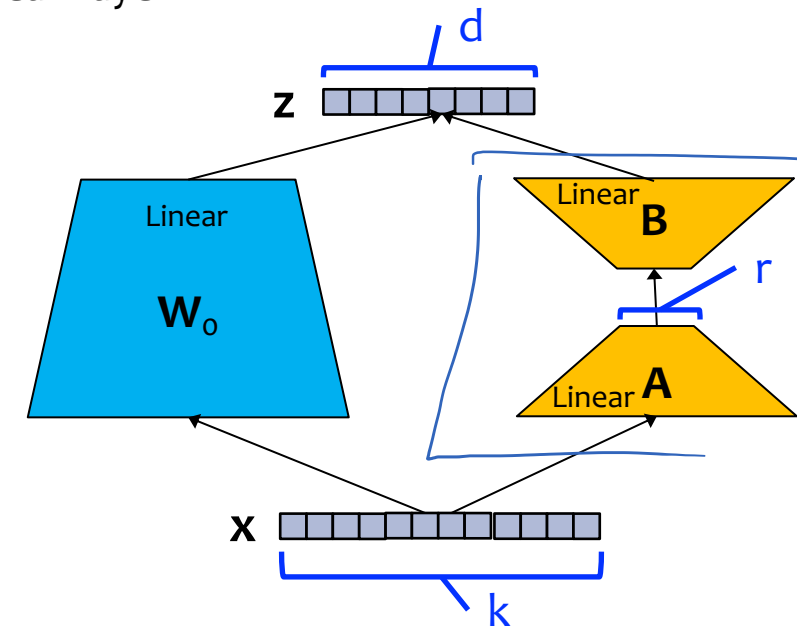

LoRA

Hot Swapping Parameters

- \mathbf{W}_0 and \mathbf{BA} have the same dimension, so we can "swap" the LoRA parameters in and out of a Standard Linear Layer
- To get a Standard Linear Layer with parameters \mathbf{W} that includes our LoRA fine tuning:

$$\mathbf{W} \leftarrow \mathbf{W}_0 + \mathbf{BA}$$

- To remove the LoRA fine tuning from that Standard Linear Layer:

$$\mathbf{W} \leftarrow \mathbf{W} - \mathbf{BA} = \mathbf{W}_0$$

- If we do LoRA training on two tasks s.t. the parameters $\mathbf{B}'\mathbf{A}'$ are for task 1 and $\mathbf{B}''\mathbf{A}''$ are for task 2, then we can swap back and forth between them

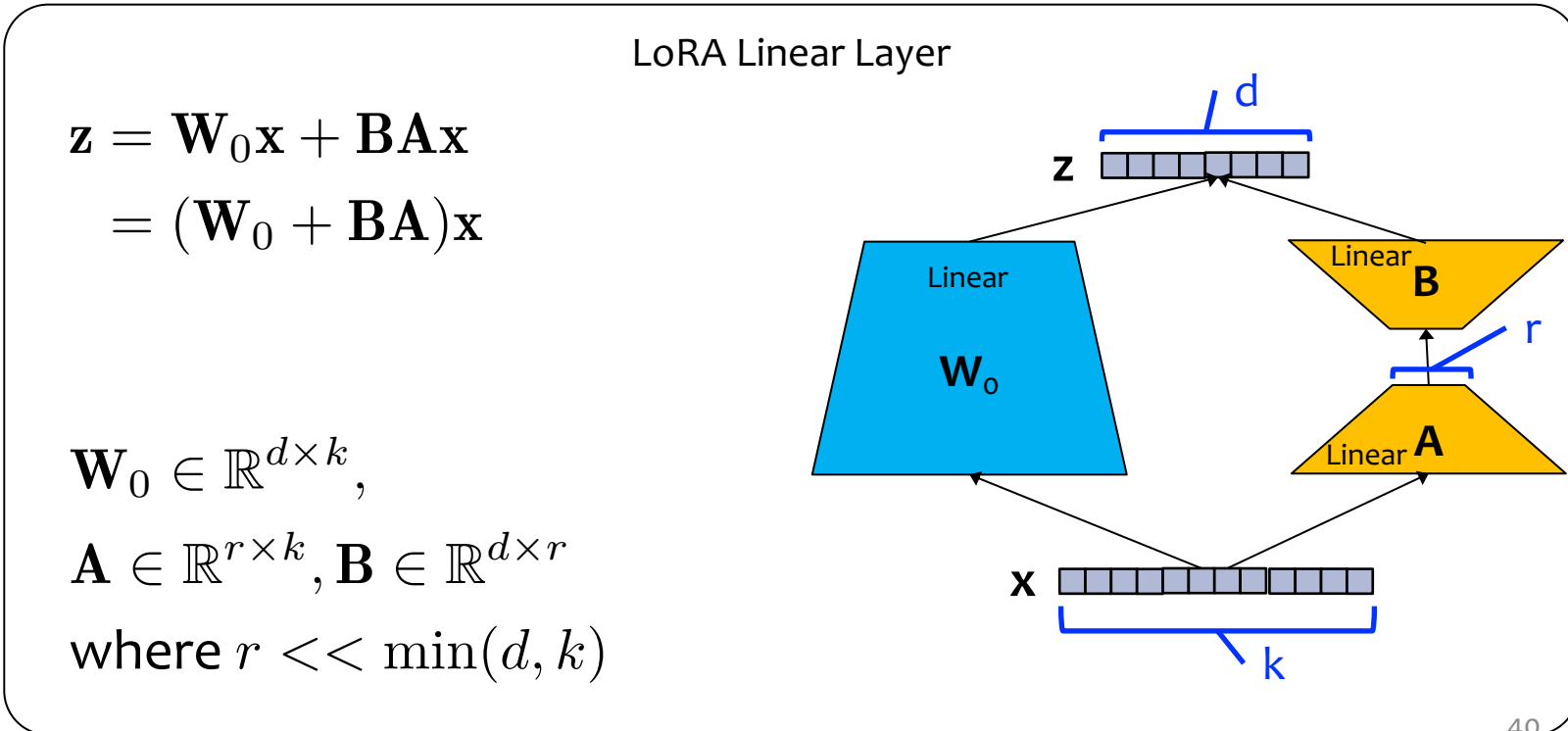
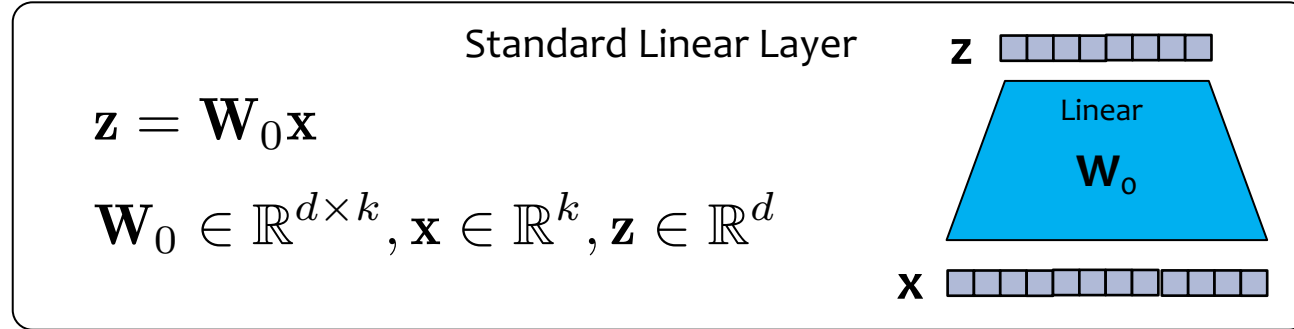

LoRA

Important Details

- LoRA itself does NOT actually touch the bias parameters
- The bias parameters are already low rank, so there's not further rank reduction to be gained there
- Most LoRA implementations provide an option to *also* fine-tune the bias parameters, but there's no fancy machinery required for this

$$\mathbf{z} = \mathbf{W}_0 \mathbf{x} + \mathbf{b} \quad \text{Standard Linear Layer}$$

$$\mathbf{W}_0 \in \mathbb{R}^{d \times k}, \mathbf{x} \in \mathbb{R}^k,$$

$$\mathbf{z} \in \mathbb{R}^d, \mathbf{b} \in \mathbb{R}^d$$

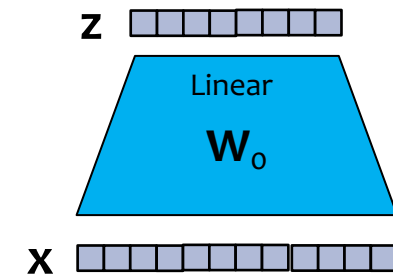

LoRA Linear Layer

$$\begin{aligned} \mathbf{z} &= \mathbf{W}_0 \mathbf{x} + \mathbf{B} \mathbf{A} \mathbf{x} + \mathbf{b} \\ &= (\mathbf{W}_0 + \mathbf{B} \mathbf{A}) \mathbf{x} + \mathbf{b} \end{aligned}$$

$$\mathbf{W}_0 \in \mathbb{R}^{d \times k},$$

$$\mathbf{A} \in \mathbb{R}^{r \times k}, \mathbf{B} \in \mathbb{R}^{d \times r}$$

$$\text{where } r \ll \min(d, k)$$

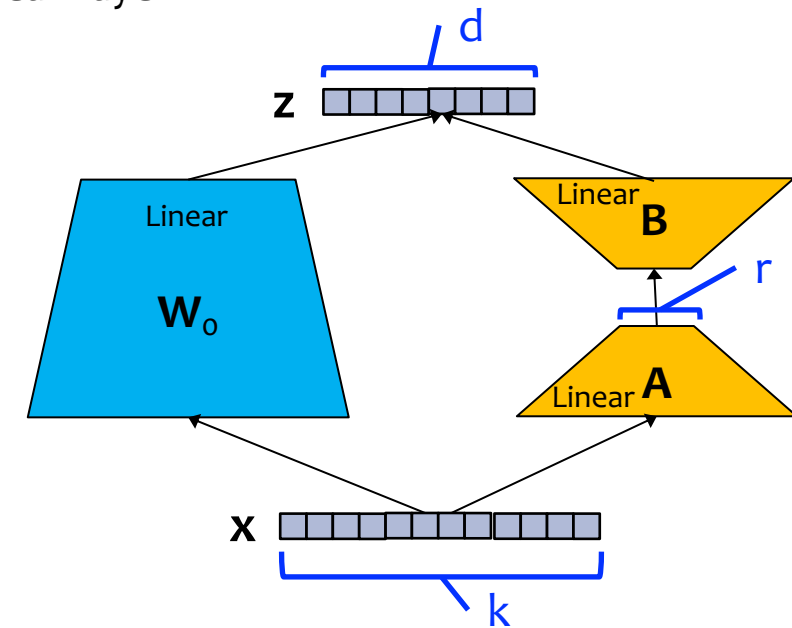

Transformer Language Model

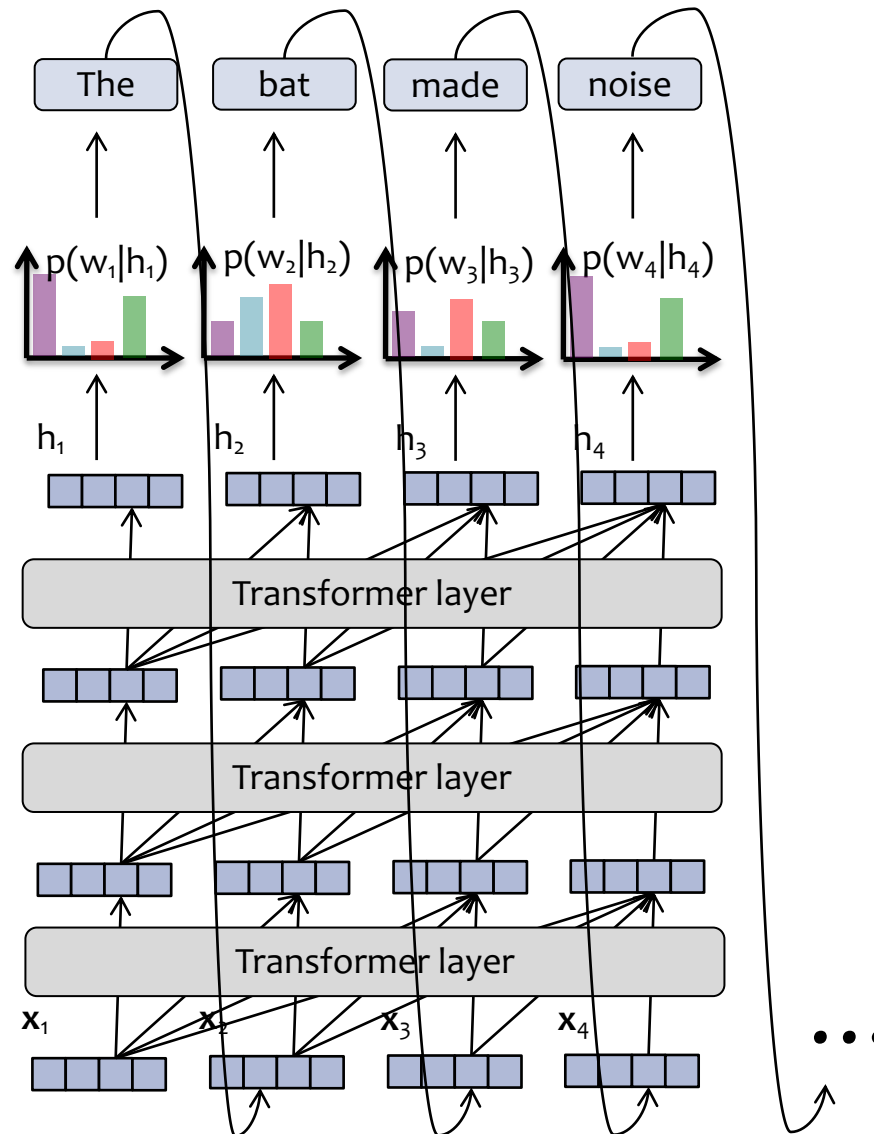

Each layer of a Transformer LM consists of several **sublayers**:

1. attention
2. feed-forward neural network
3. layer normalization
4. residual connections

Each hidden vector looks back at the hidden vectors of the **current and previous timesteps in the previous layer**.

The language model part is just like an RNN-LM.

Transformer Layer

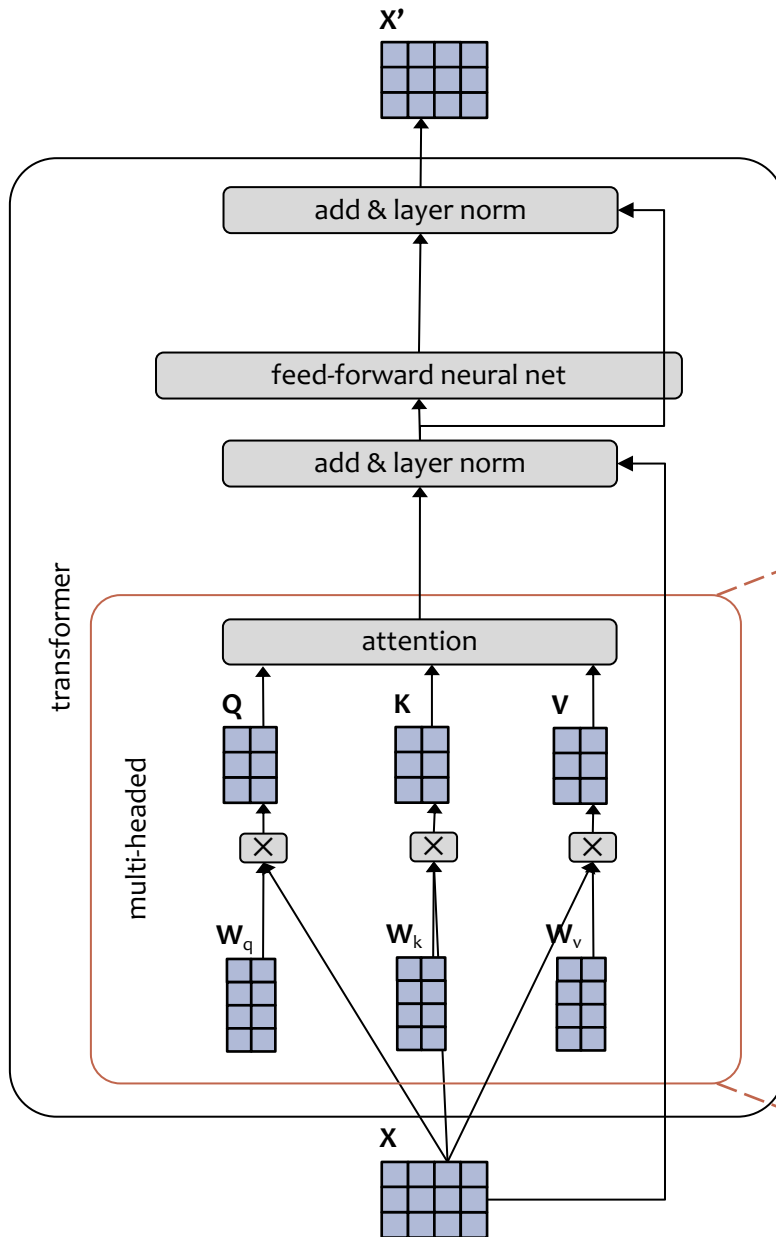

multi-headed attention

$$\mathbf{X}'' = \text{concat}(\mathbf{X}'^{(1)}, \dots, \mathbf{X}'^{(h)})$$

$$\mathbf{X}'^{(i)} = \text{softmax} \left(\frac{\mathbf{Q}^{(i)} (\mathbf{K}^{(i)})^T}{\sqrt{d_k}} + \mathbf{M} \right) \mathbf{V}^{(i)}$$

$$\mathbf{Q}^{(i)} = \mathbf{X} \mathbf{W}_q^{(i)}$$

$$\mathbf{K}^{(i)} = \mathbf{X} \mathbf{W}_k^{(i)}$$

$$\mathbf{V}^{(i)} = \mathbf{X} \mathbf{W}_v^{(i)}$$

$$\mathbf{X} = [\mathbf{x}_1, \dots, \mathbf{x}_N]^T$$

LoRA for Transformer

- LoRA linear layers could replace every linear layer in the Transformer layer
- But the original paper only applies LoRA to the attention weights

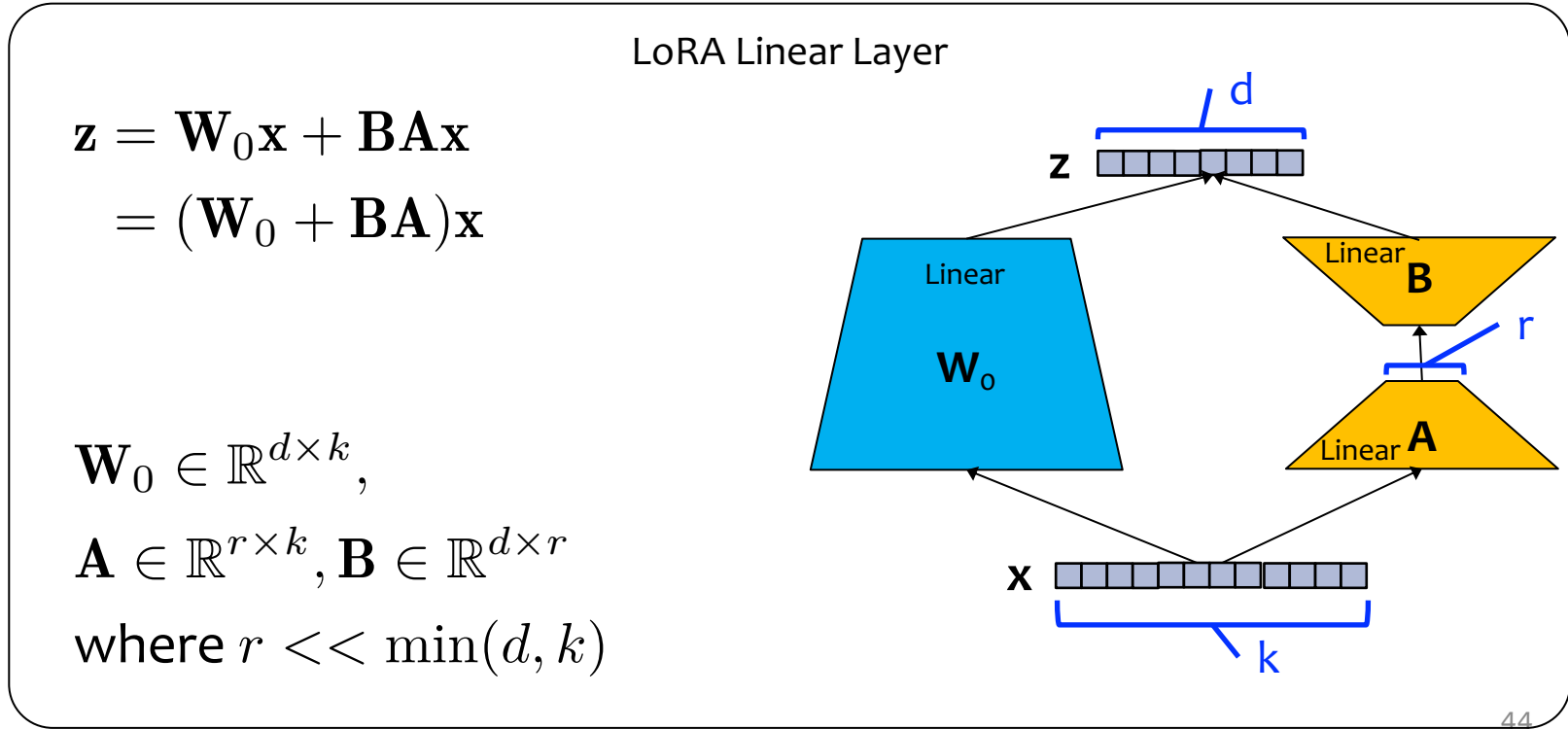
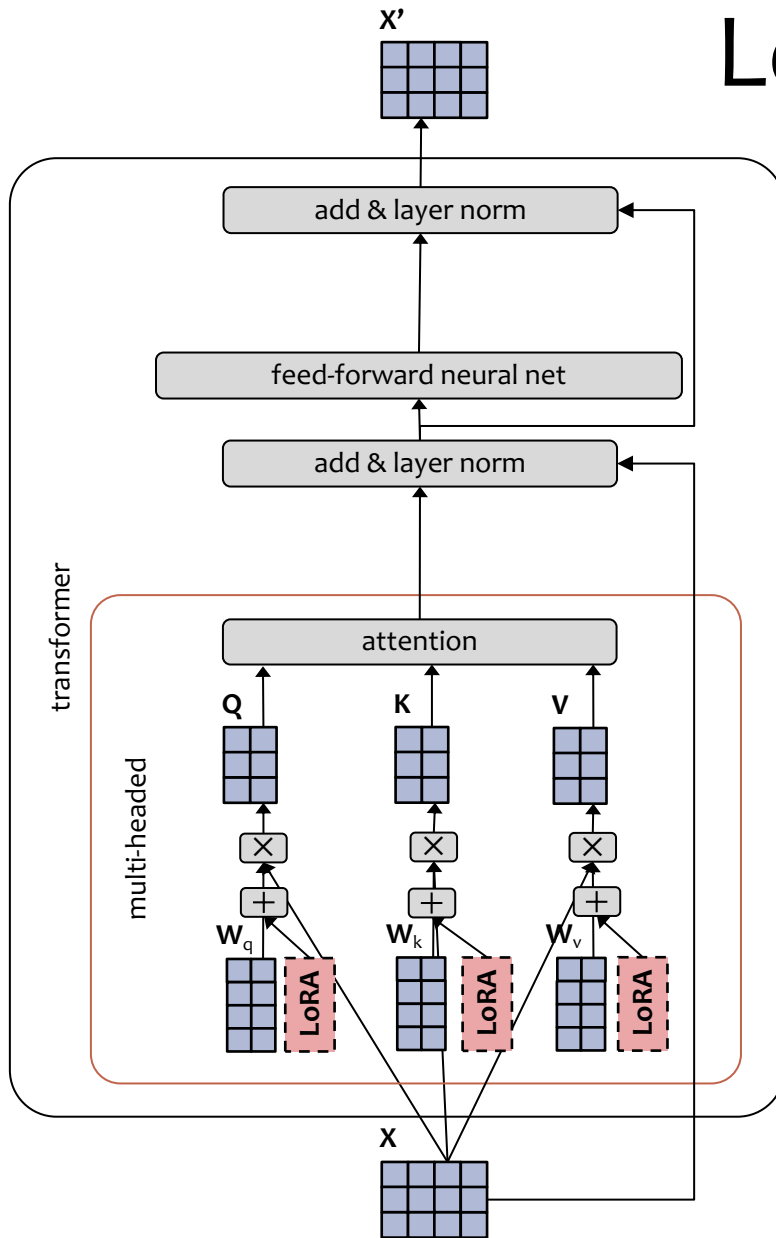

LoRA for Transformer

- LoRA linear layers could replace every linear layer in the Transformer layer
- But the original paper only applies LoRA to the attention weights

$$Q = \text{LoRALinear}(X; W_q, A_q, B_q)$$

$$K = \text{LoRALinear}(X; W_k, A_k, B_k)$$

$$V = \text{LoRALinear}(X; W_v, A_v, B_v)$$

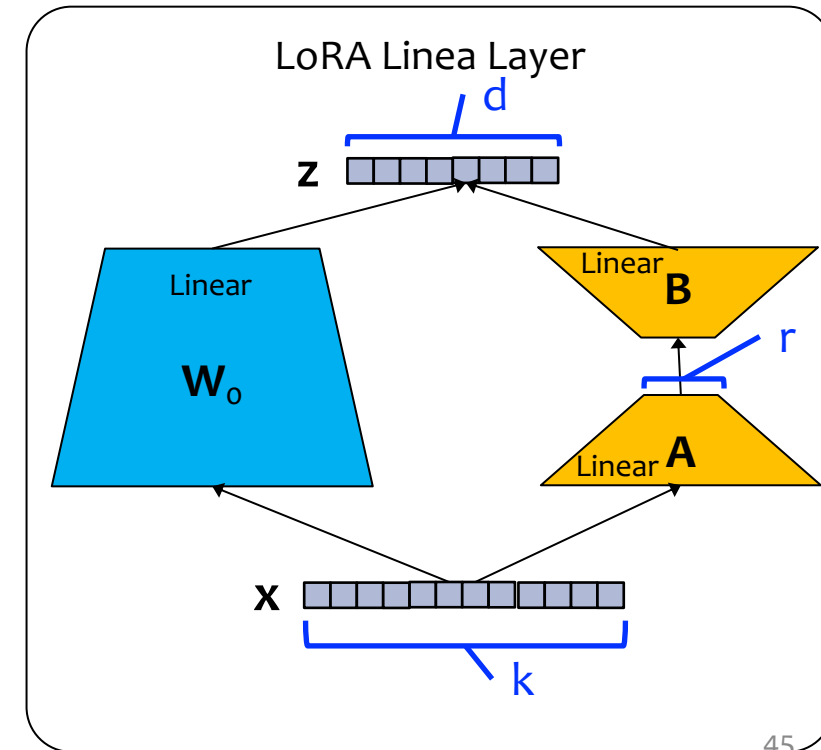
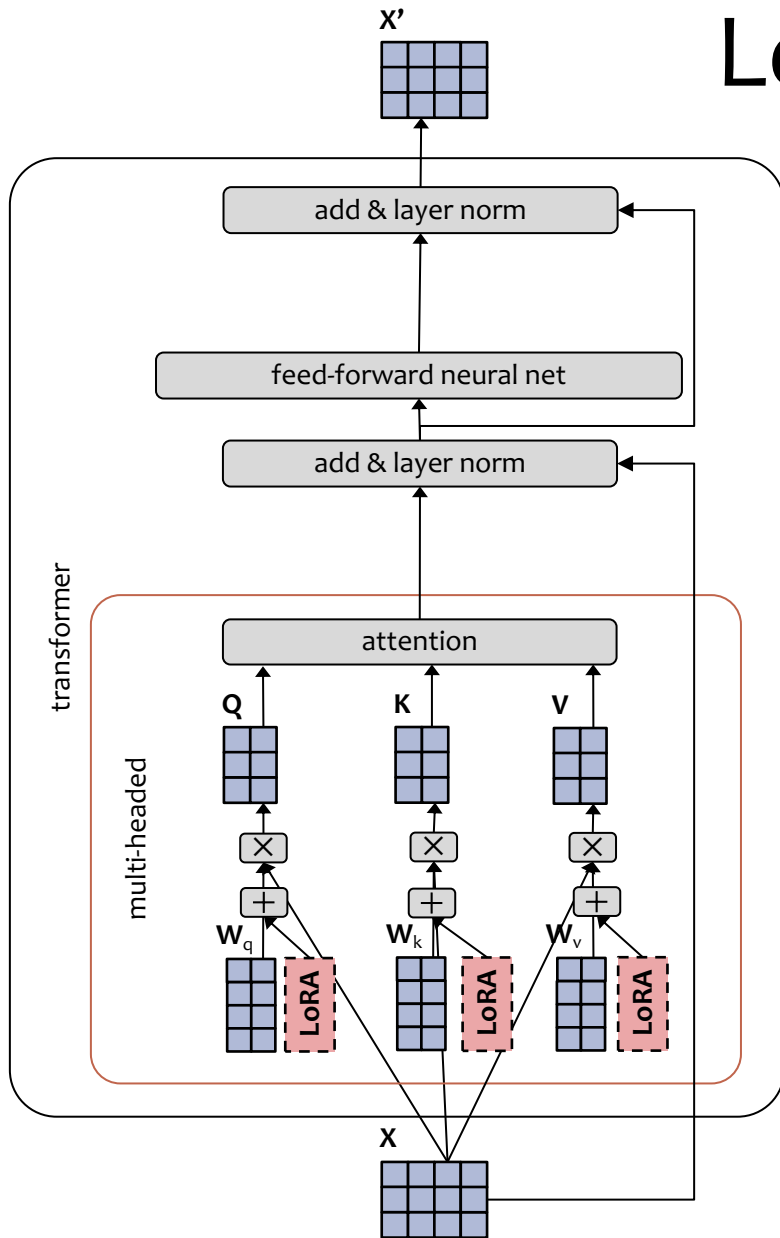

LoRA for Transformer

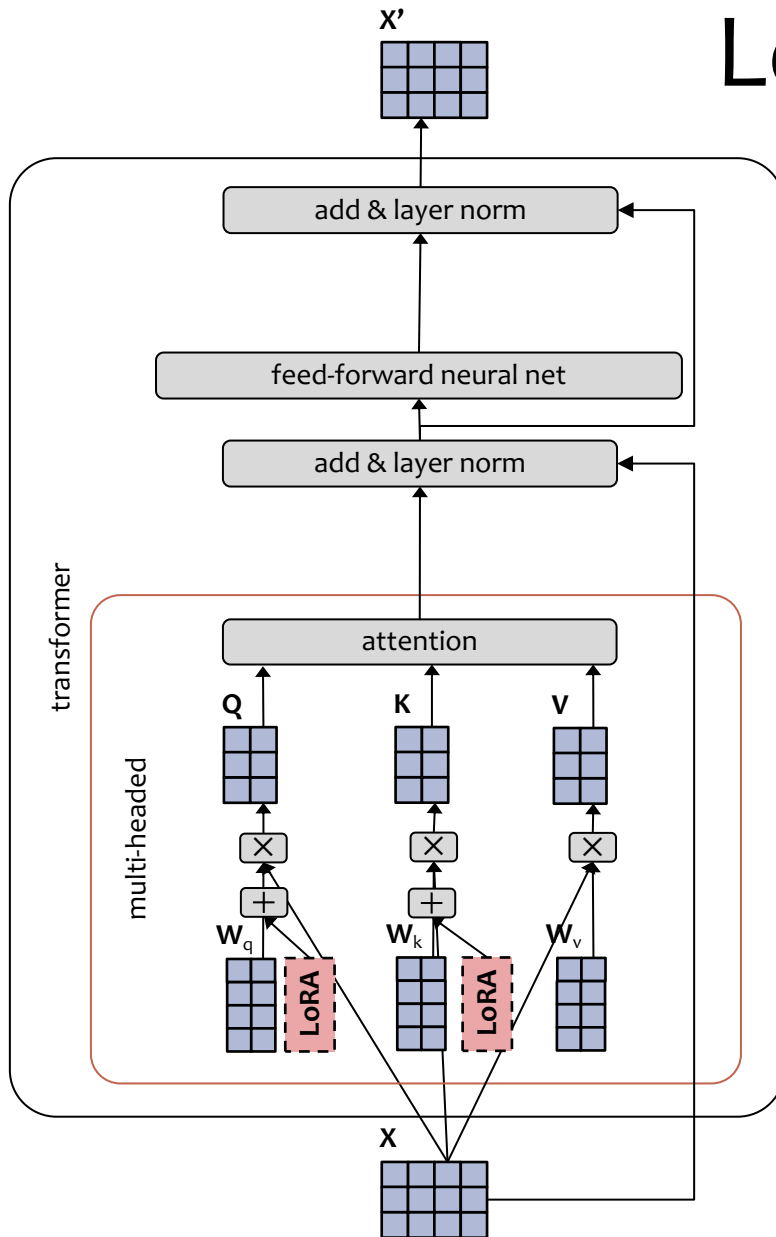

- LoRA linear layers could replace every linear layer in the Transformer layer
- But the original paper only applies LoRA to the attention weights
- Empirically, for GPT-3, they also find that it is most efficient to include LoRA **only on the query and value** linear layers

	# of Trainable Parameters = 18M						
Weight Type	W_q	W_k	W_v	W_o	W_q, W_k	W_q, W_v	W_q, W_k, W_v, W_o
Rank r	8	8	8	8	4	4	2
WikiSQL ($\pm 0.5\%$)	70.4	70.0	73.0	73.2	71.4	73.7	73.7
MultiNLI ($\pm 0.1\%$)	91.0	90.8	91.0	91.3	91.3	91.3	91.7

Table 5: Validation accuracy on WikiSQL and MultiNLI after applying LoRA to different types of attention weights in GPT-3, given the same number of trainable parameters. Adapting both W_q and W_v gives the best performance overall. We find the standard deviation across random seeds to be consistent for a given dataset, which we report in the first column.

LoRA for Transformer

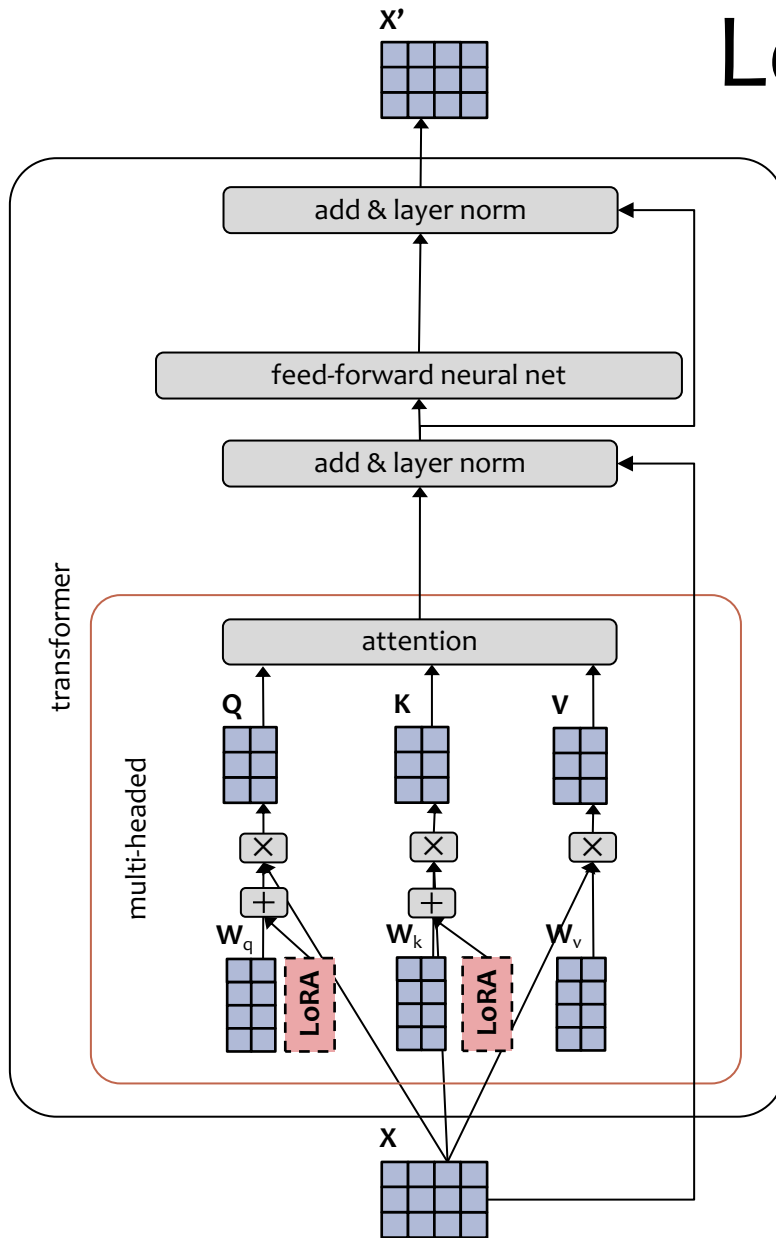

- LoRA linear layers could replace every linear layer in the Transformer layer
- But the original paper only applies LoRA to the attention weights
- Empirically, for GPT-3, they also find that it is most efficient to include LoRA **only on the query and value** linear layers
- During training only the new LoRA parameters are fine-tuned, all the other parameters are kept fixed

LoRA Results

Takeaways

- Applied to GPT-3, LoRA achieves performance almost as good as full fine-tuning, but with far fewer parameters
- On some tasks it even outperforms full fine-tuning
- For some datasets a rank of $r=1$ is sufficient
- LoRA performs well when the dataset is large or small

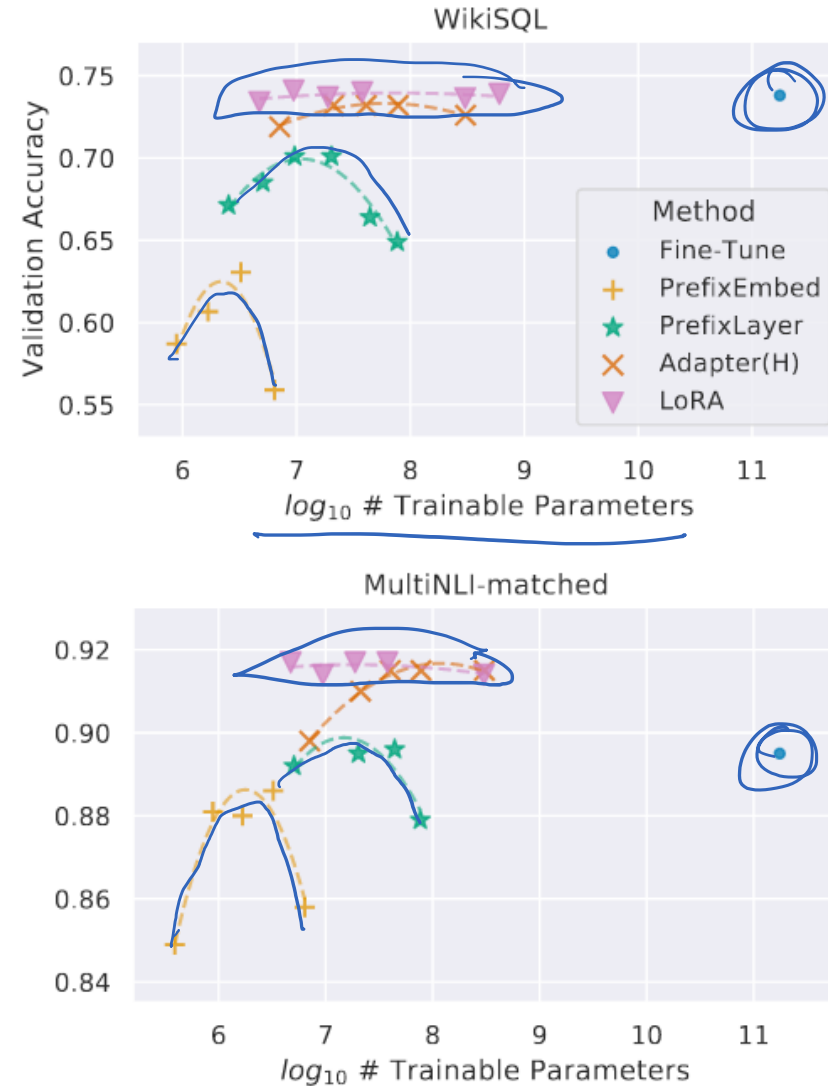

LoRA Results

Takeaways

- Applied to GPT-3, LoRA achieves performance almost as good as full fine-tuning, but with far fewer parameters
- On some tasks it even outperforms full fine-tuning
- For some datasets a rank of $r=1$ is sufficient
- LoRA performs well when the dataset is large or small

	Weight Type	$r = 1$	$r = 2$	$r = 4$	$r = 8$	$r = 64$
WikiSQL($\pm 0.5\%$)	W_q	68.8	69.6	70.5	70.4	70.0
	W_q, W_v	73.4	73.3	73.7	73.8	73.5
	W_q, W_k, W_v, W_o	74.1	73.7	74.0	74.0	73.9
MultiNLI ($\pm 0.1\%$)	W_q	90.7	90.9	91.1	90.7	90.7
	W_q, W_v	91.3	91.4	91.3	91.6	91.4
	W_q, W_k, W_v, W_o	91.2	91.7	91.7	91.5	91.4

Method	MNLI(m)-100	MNLI(m)-1k	MNLI(m)-10k	MNLI(m)-392K
GPT-3 (Fine-Tune)	60.2	85.8	88.9	89.5
GPT-3 (PrefixEmbed)	37.6	75.2	79.5	88.6
GPT-3 (PrefixLayer)	48.3	82.5	85.9	89.6
GPT-3 (LoRA)	63.8	85.6	89.2	91.7

PEFT for Transformer

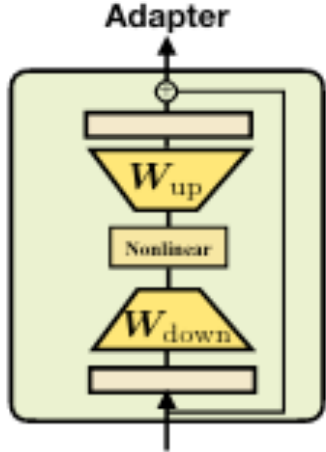
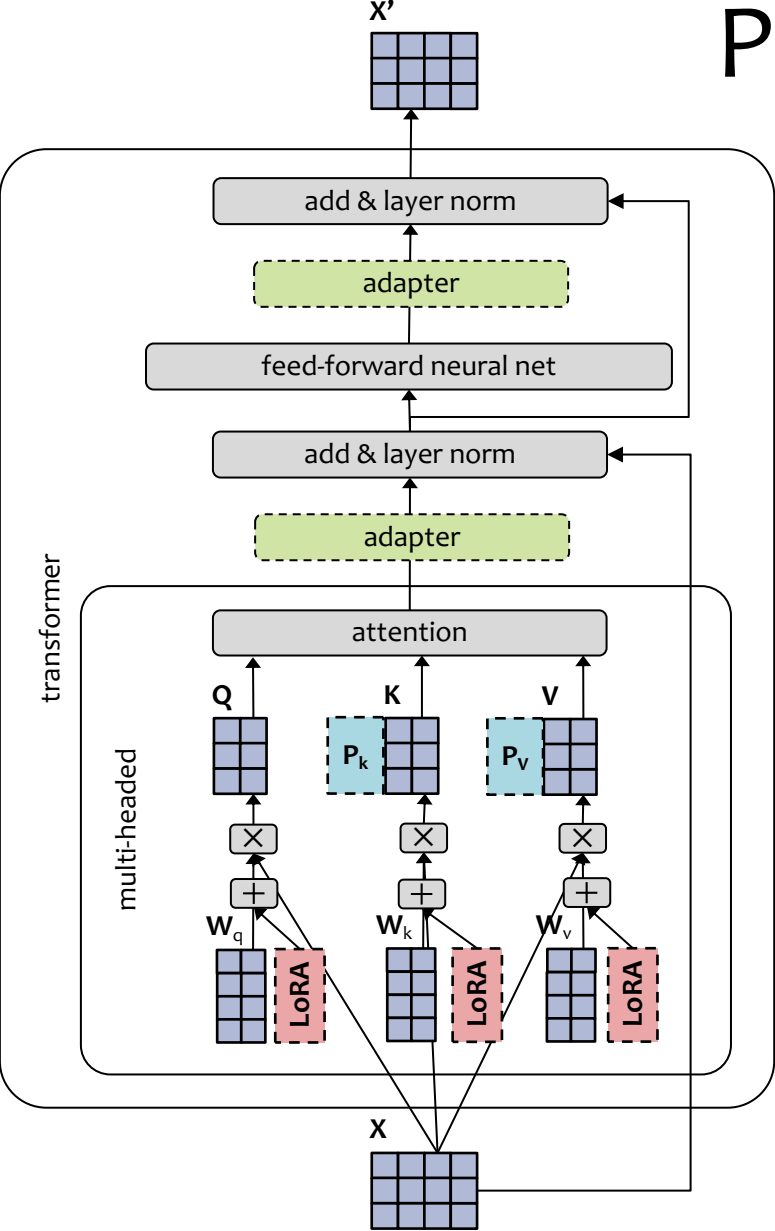

Prefix Tuning

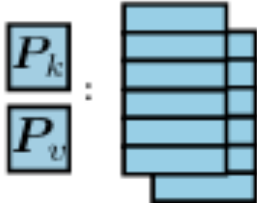

LoRA

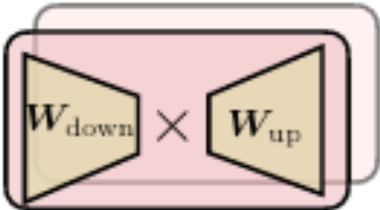

Figure inspired by / copied from He et al. (2022)

LoRA Memory Usage

- Question: During training, why does LoRA use less memory than full fine-tuning if we still need all those pre-trained parameters?
- Answer:
 - The number of parameters in memory is *greater* than before
 - But many fewer gradients are needed
 - Therefore less optimizer state is required

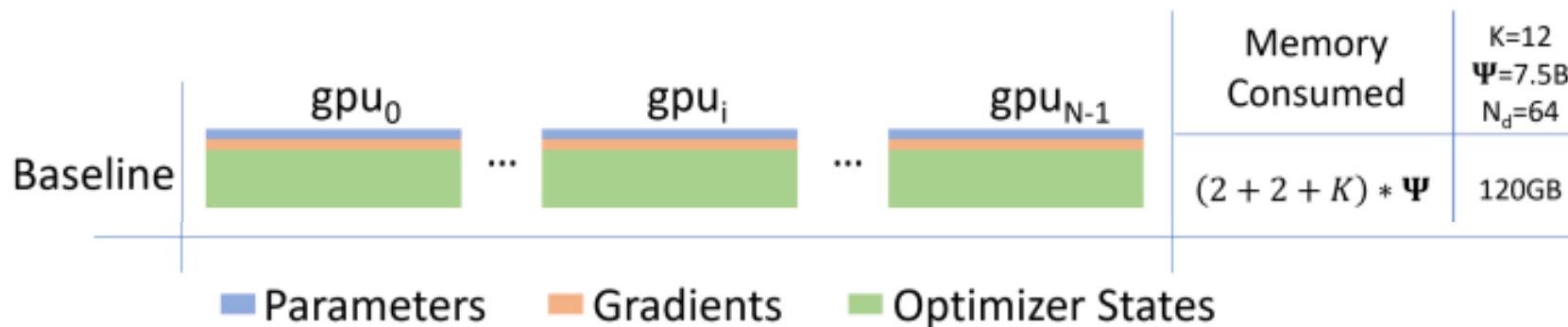

Figure 1: Comparing the per-device memory consumption of model states, with three stages of *ZeRO*-DP optimizations. Ψ denotes model size (number of parameters), K denotes the memory multiplier of optimizer states, and N_d denotes DP degree. In the example, we assume a model size of $\Psi = 7.5B$ and DP of $N_d = 64$ with $K = 12$ based on mixed-precision training with Adam optimizer.

PEFT Computation Time

One of the primary reasons people use PEFT is to obtain faster training time. Yet it is very nuanced *why* we get this speedup.

There are three ways in which we expect the computation time to change:

1. We expect **slowdown** from additional computation. (true of lora, adapters, prefix tuning; not true of top-k layers)
2. We expect **speedup** from fewer gradient computations (true for all four methods).
3. We expect **speedup** from being able to use a larger batch size because we use so much less GPU memory (true for all four methods)

Which of these slowdown/speedup changes wins out is non-trivial and might even depend on the hyperparameters of the PEFT method.

Example: how throughput changes with LoRA on LLAMA-2-7B:

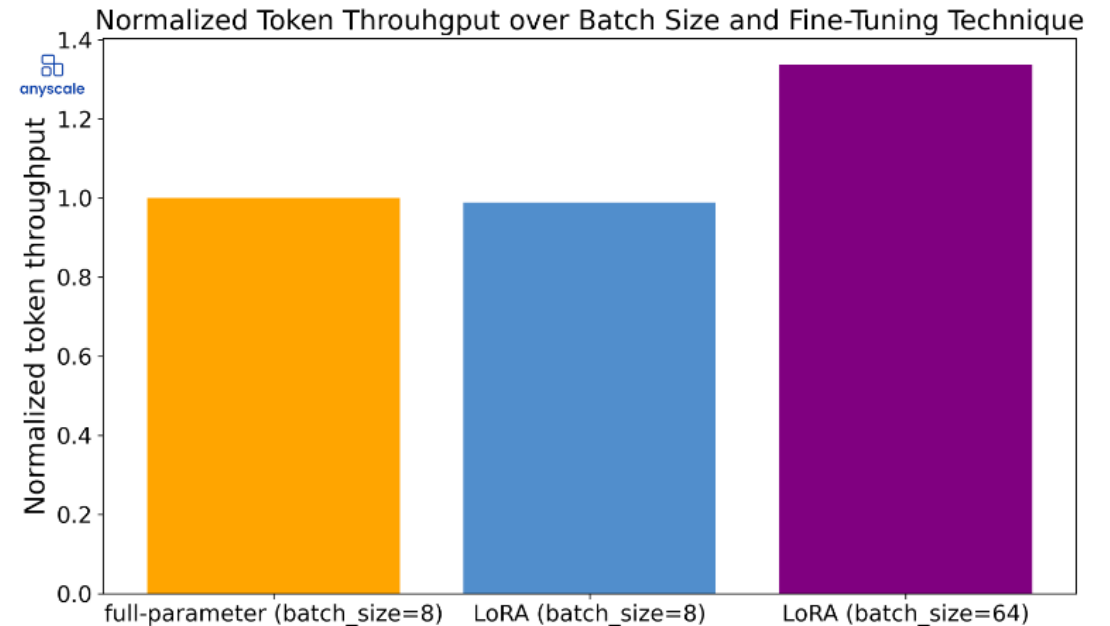

A comparison of training throughput (tokens per second) for the 7B model with a context length of 512 on a p4de.24xlarge node. The lower memory footprint of LoRA allows for substantially larger batch sizes, resulting in an approximate 30% boost in throughput.

PEFT FOR VISION TRANSFORMER

PEFT for Vision Transformer

- Since Vision Transformer is just another transformer model, we can apply LoRA directly to it
- (LNLoRA is just a variant that includes LayerNorm in the LoRALinear module.)

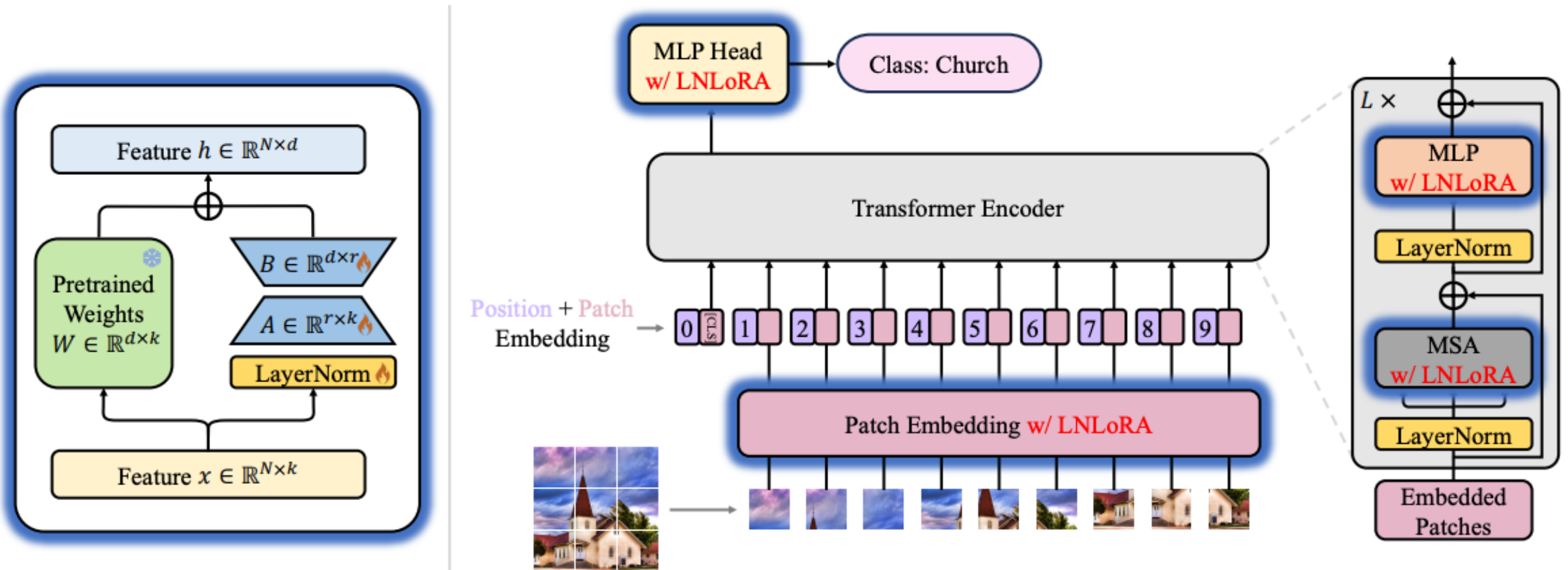

PEFT for Vision Transformer

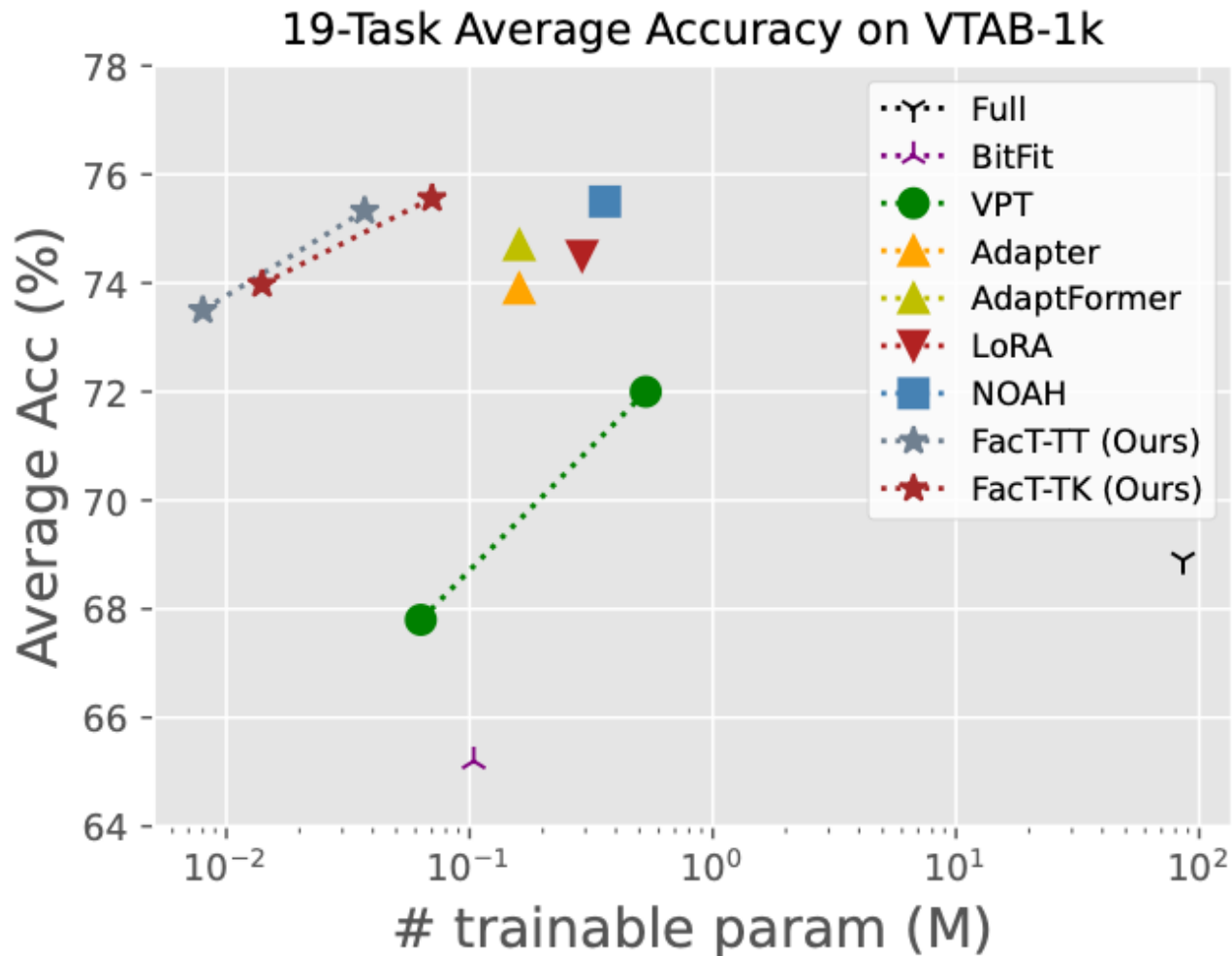

- For various computer vision tasks, parameter efficient transfer-learning (PETL) is sometimes **better** than full fine-tuning!
- VTAB-1k is a collection of 19 different vision tasks; here we're seeing average performance across tasks
- (FacT is another low-rank method capable of dramatically reducing the number of parameters tuned.)