

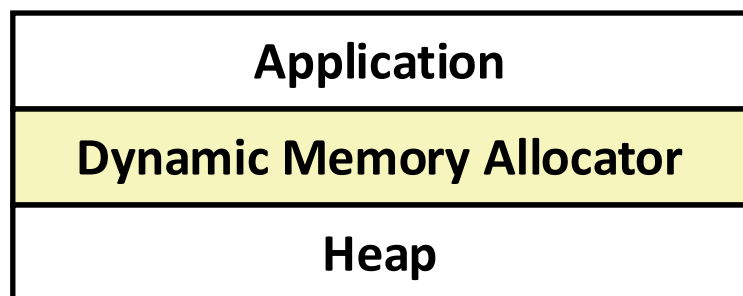

Dynamic Memory Allocation: Advanced Concepts

18-213/18-613: Introduction to Computer Systems
14th Lecture, Spring 2026

Review: Dynamic Memory Allocation



- Programmers use *dynamic memory allocators* (such as `malloc`) to acquire virtual memory (VM) at run time.
 - for data structures whose size is only known at runtime
- Dynamic memory allocators manage an area of process VM known as the *heap*.

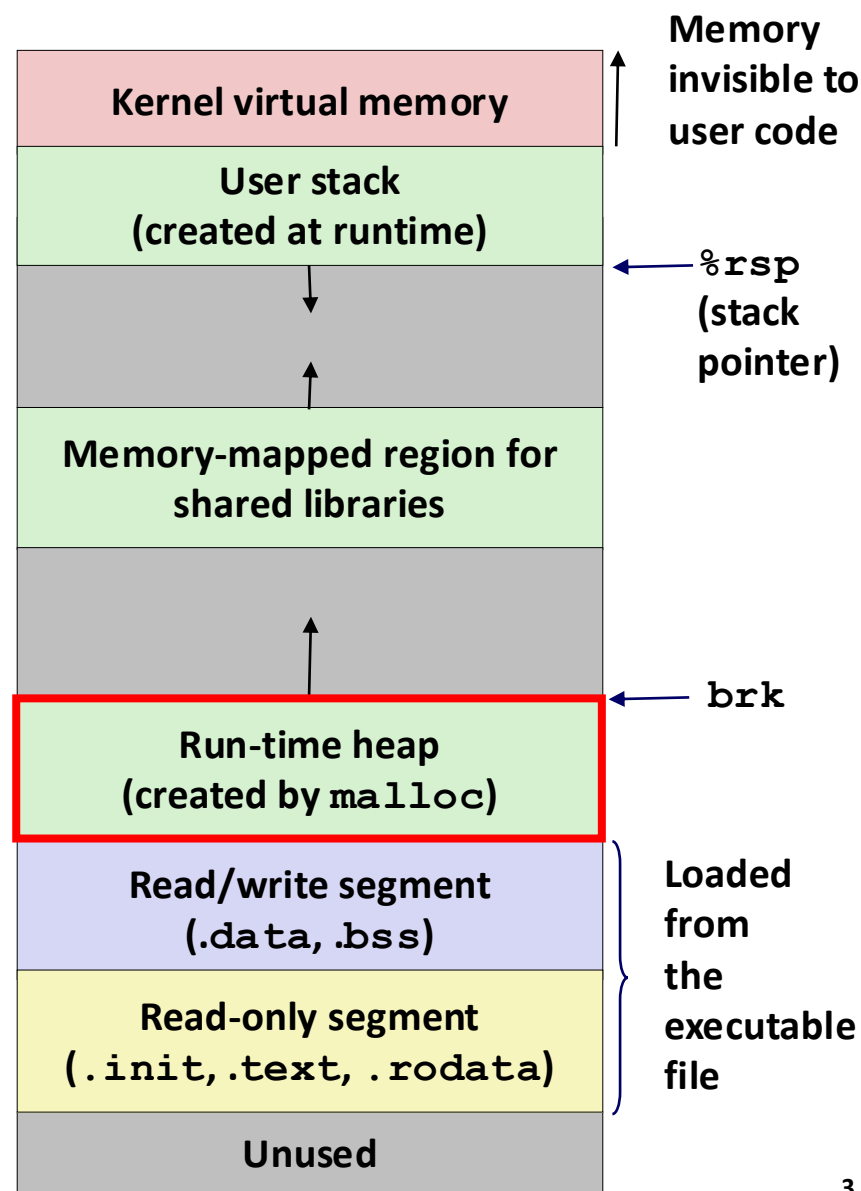

Review: Keeping Track of Free Blocks

- Method 1: *Implicit list* using length—links all blocks

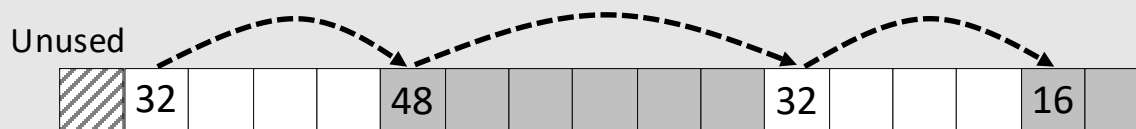

Need to tag each block as allocated/free

- Method 2: *Explicit list* among the free blocks using pointers

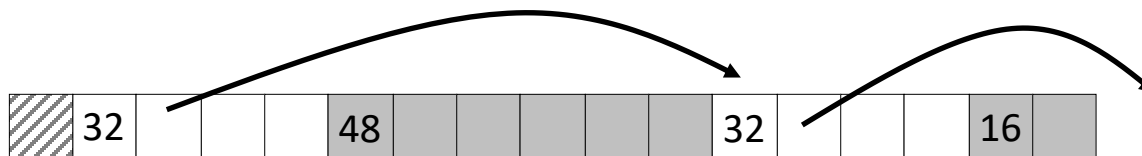

Need space for pointers

- Method 3: *Segregated free list*

- Different free lists for different size classes

- Method 4: *Blocks sorted by size*

- Can use a balanced tree (e.g. Red-Black tree) with pointers within each free block, and the length used as a key

Review: Boundary Tags for Coalescing

■ *Boundary tags*

- Replicate size/allocated word at “bottom” (end) of free blocks
- Allows us to traverse the “list” backwards, but requires extra space
- Important and general technique!

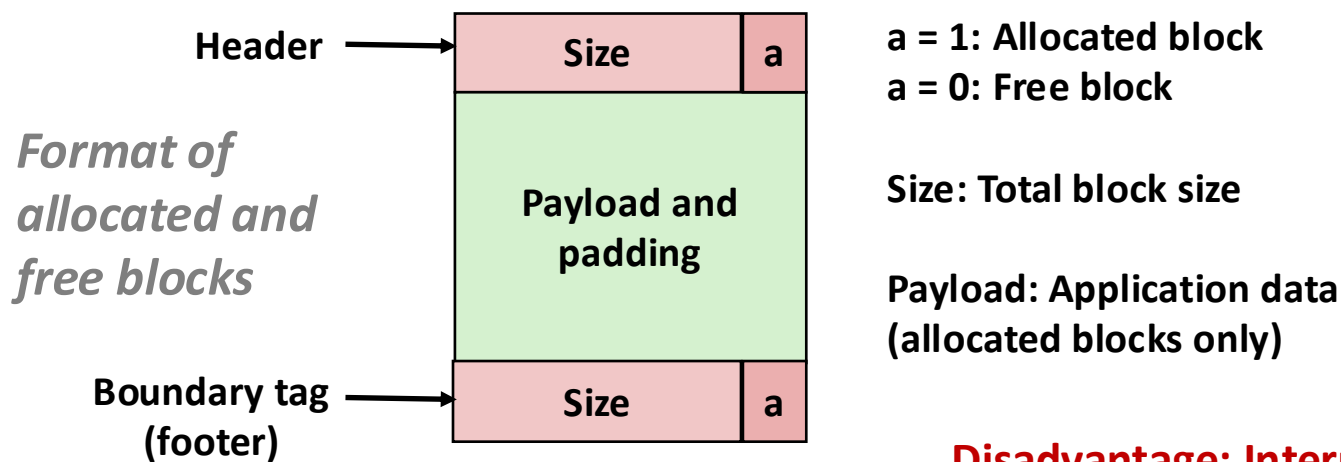
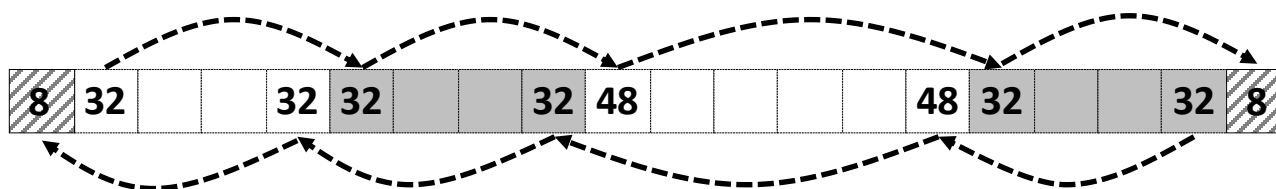

Disadvantage: Internal fragmentation

Review: Internal vs. External Fragmentation

- For a given block, *internal fragmentation* occurs if payload is smaller than block size

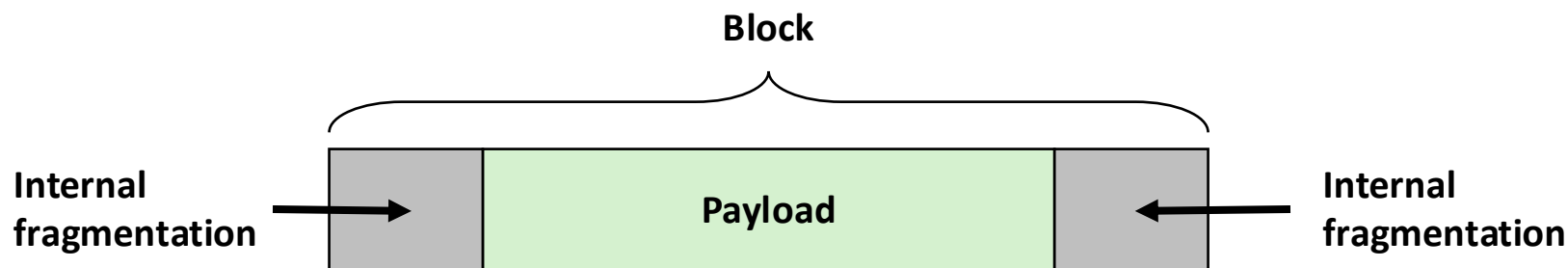

- *External fragmentation* occurs when there is enough aggregate heap memory, but no single free block is large enough



```
p4 = malloc(7*sizeof(size_t))
```

Review: No Boundary Tag for Allocated Blocks

- Boundary tag needed only for free blocks
- When sizes are multiples of 16, have 4 spare bits

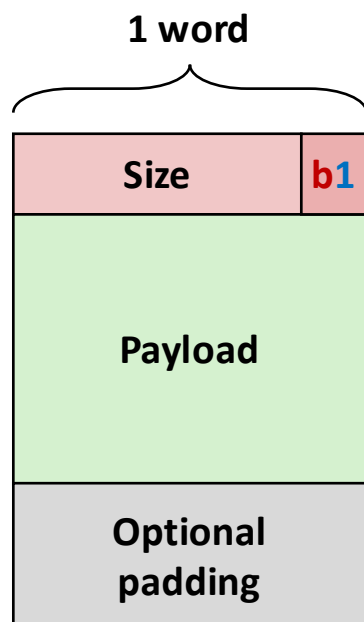

**Allocated
Block**

a = 1: Allocated block
a = 0: Free block
b = 1: Previous block is allocated
b = 0: Previous block is free

Size: block size

Payload: application data

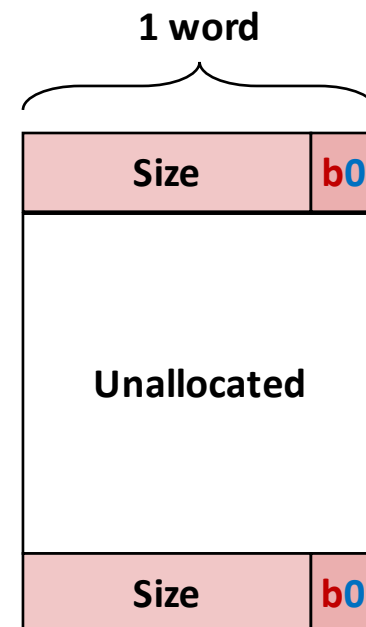

**Free
Block**

No Boundary Tag for Allocated Blocks (Case 1)

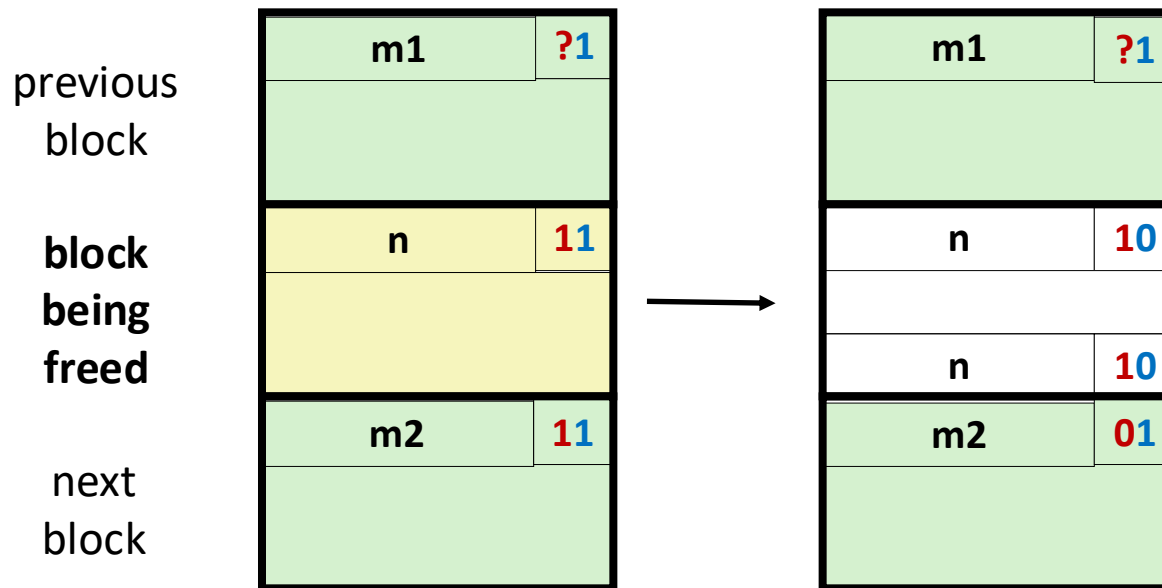

Header: Use 2 bits (address bits always zero due to alignment):
(previous block allocated) $\ll 1$ | **(current block allocated)**

No Boundary Tag for Allocated Blocks (Case 2)

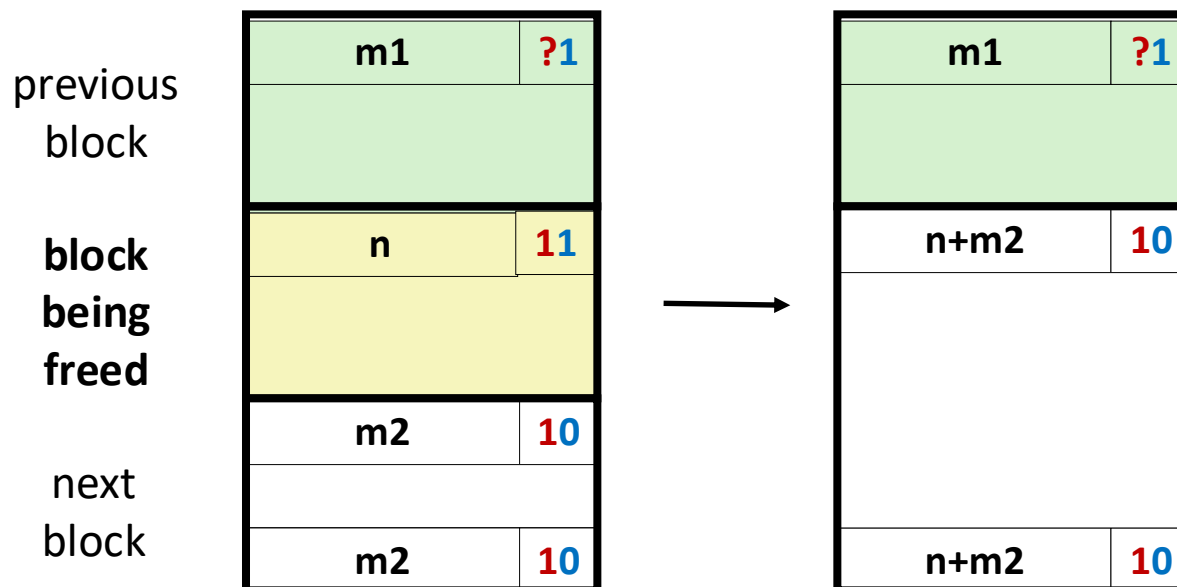

Header: Use 2 bits (address bits always zero due to alignment):
 (previous block allocated) $\ll 1$ | (current block allocated)

No Boundary Tag for Allocated Blocks (Case 3)

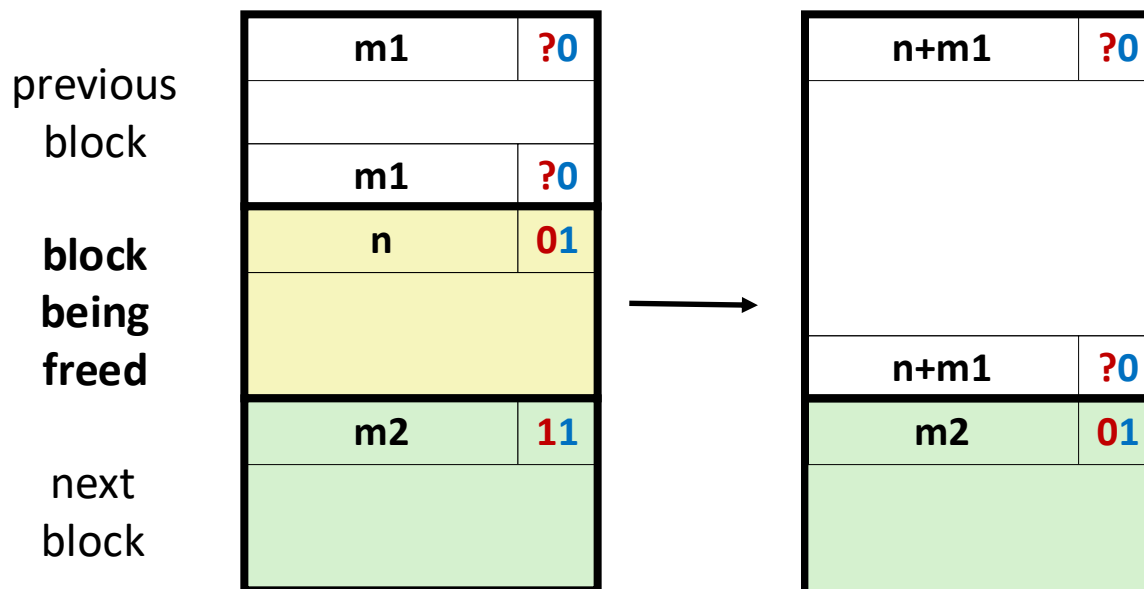

Header: Use 2 bits (address bits always zero due to alignment):
(previous block allocated) $\ll 1$ | **(current block allocated)**

No Boundary Tag for Allocated Blocks (Case 4)

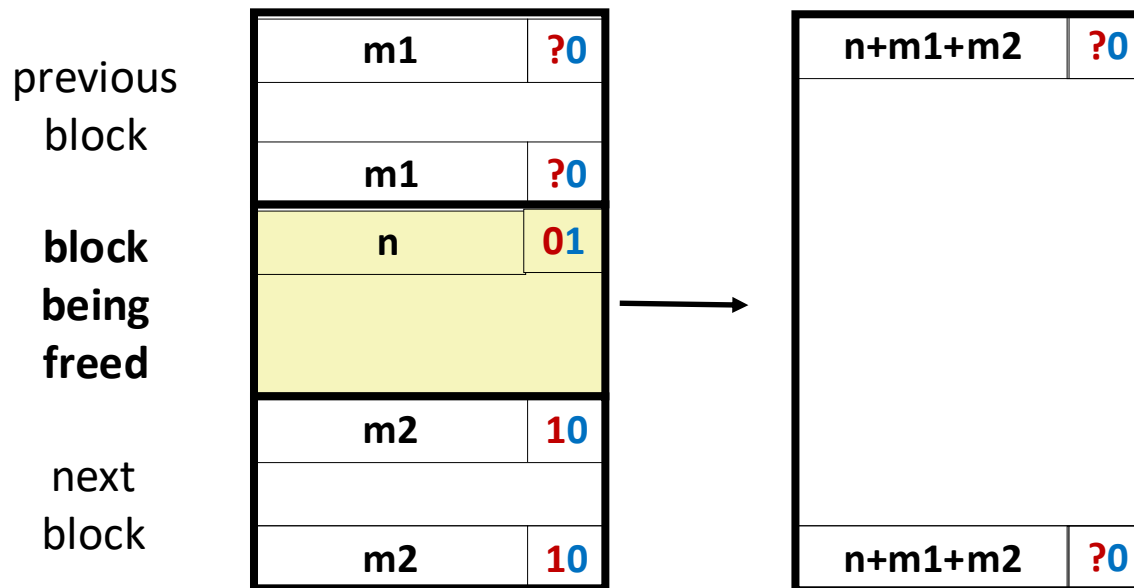

Header: Use 2 bits (address bits always zero due to alignment):
(previous block allocated) $\ll 1$ | **(current block allocated)**

Implicit Lists Summary

- **Implementation: very simple**
- **Allocate cost:**
 - linear time worst case
- **Free cost:**
 - constant time worst case
 - even with coalescing
- **Memory Overhead:**
 - Depends on placement policy
 - Strategies include first fit, next fit, and best fit
- **Not used in practice for `malloc/free` because of linear-time allocation**
 - used in many special purpose applications
- **However, the concepts of splitting and boundary tag coalescing are general to *all* allocators**

Today

- Implicit free lists (review)
- **Explicit free lists** CSAPP 9.9.13
- **Segregated free lists** CSAPP 9.9.14
- **Memory-related perils and pitfalls** CSAPP 9.11

Keeping Track of Free Blocks

- Method 1: *Implicit list* using length—links all blocks

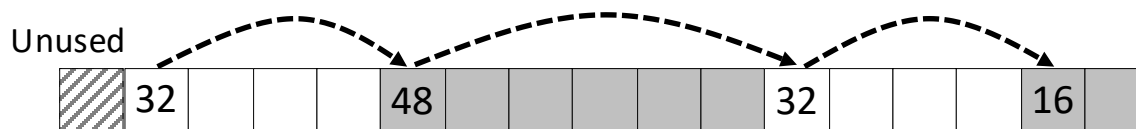

- Method 2: *Explicit list* among the free blocks using pointers

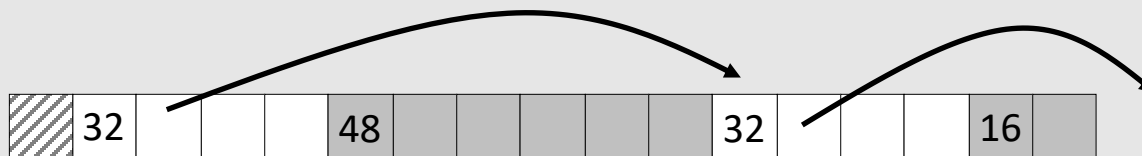

- Method 3: *Segregated free list*

- Different free lists for different size classes

- Method 4: *Blocks sorted by size*

- Can use a balanced tree (e.g. Red-Black tree) with pointers within each free block, and the length used as a key

Explicit Free Lists

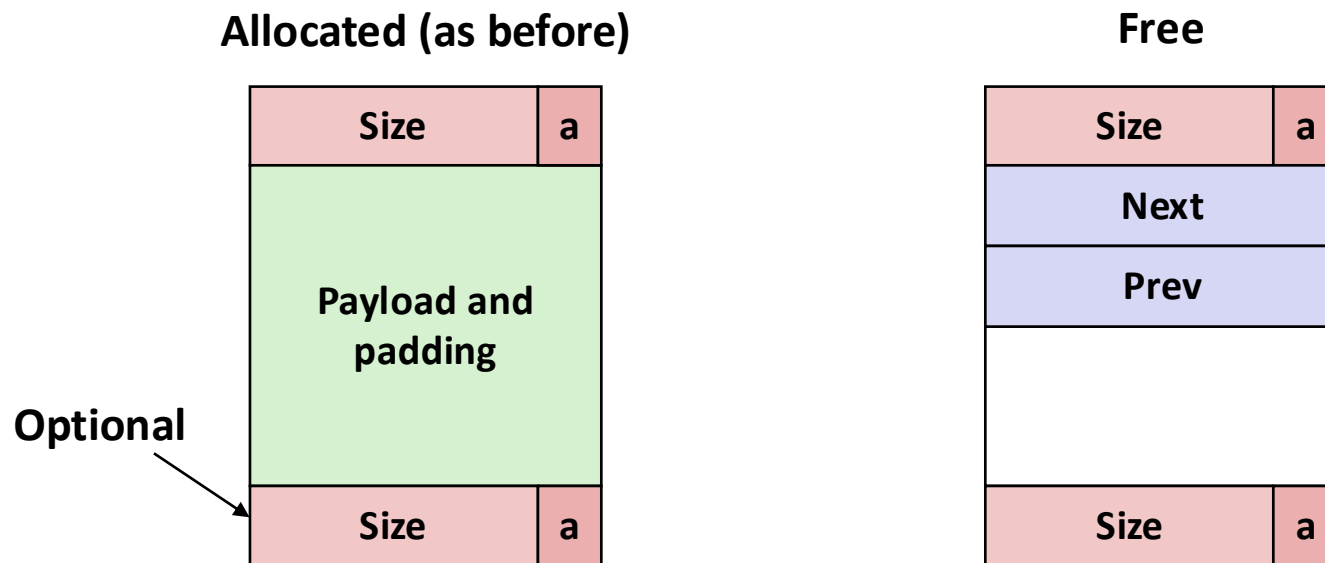

- Maintain list(s) of *free* blocks, not *all* blocks
 - Luckily we track only free blocks, so we can use payload area
 - The “next” free block could be anywhere
 - So we need to store forward/back pointers, not just sizes
 - Still need boundary tags for coalescing
 - To find adjacent blocks according to memory order

Explicit Free Lists

- Logically:



- Physically: blocks can be in any order

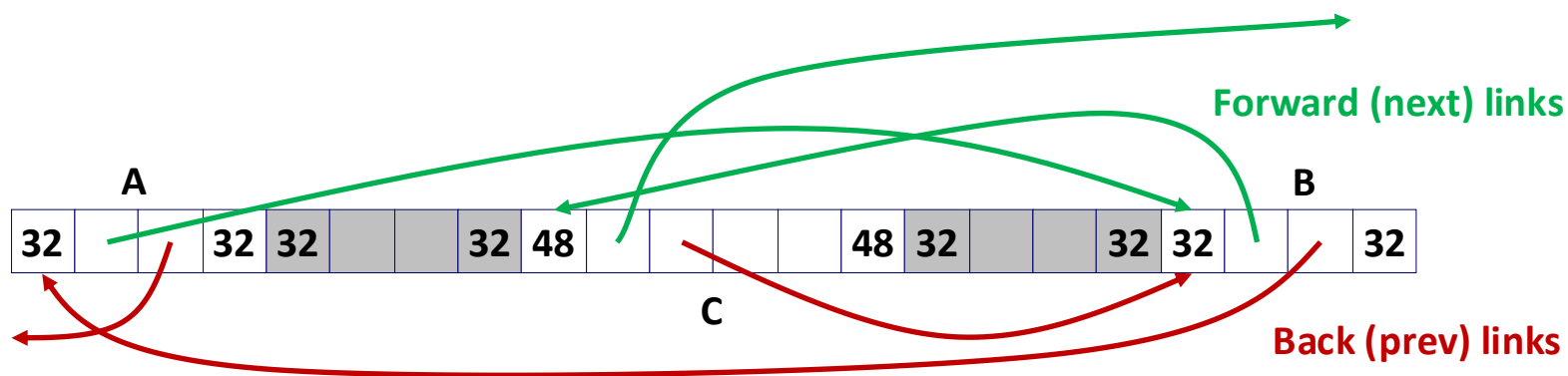

Allocating From Explicit Free Lists

conceptual graphic

Before

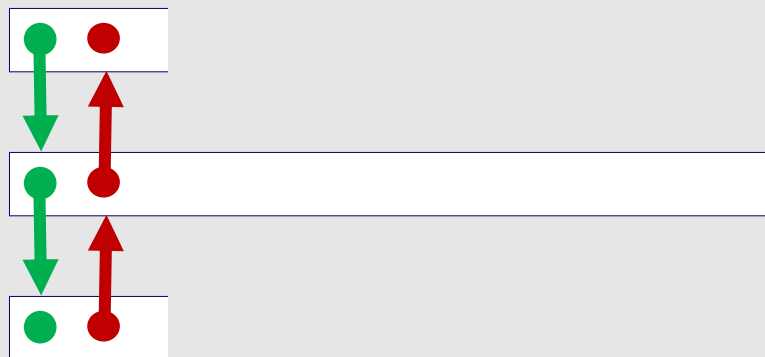

After

(with splitting)

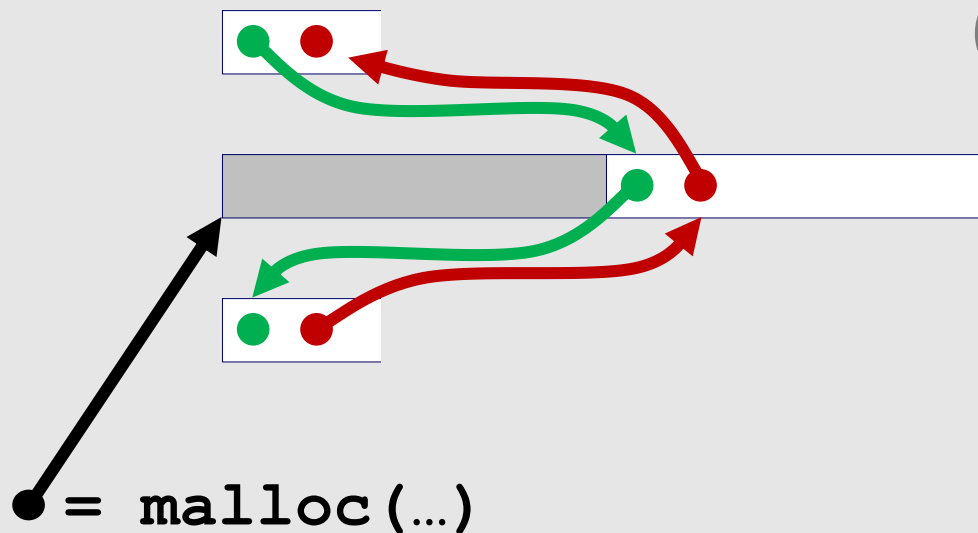

Freeing With Explicit Free Lists

- ***Insertion policy:*** Where in the free list do you put a newly freed block?
- **Unordered**
 - LIFO (last-in-first-out) policy
 - Insert freed block at the beginning of the free list
 - FIFO (first-in-first-out) policy
 - Insert freed block at the end of the free list
 - ***Pro:*** simple and constant time
 - ***Con:*** studies suggest fragmentation is worse than address ordered
- **Address-ordered policy**
 - Insert freed blocks so that free list blocks are always in address order:
 $addr(prev) < addr(curr) < addr(next)$
 - ***Con:*** requires search
 - ***Pro:*** studies suggest fragmentation is lower than LIFO/FIFO

Freeing With a LIFO Policy (Case 1)

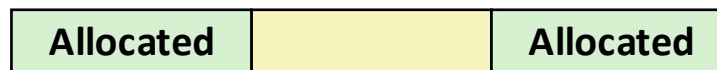

conceptual graphic

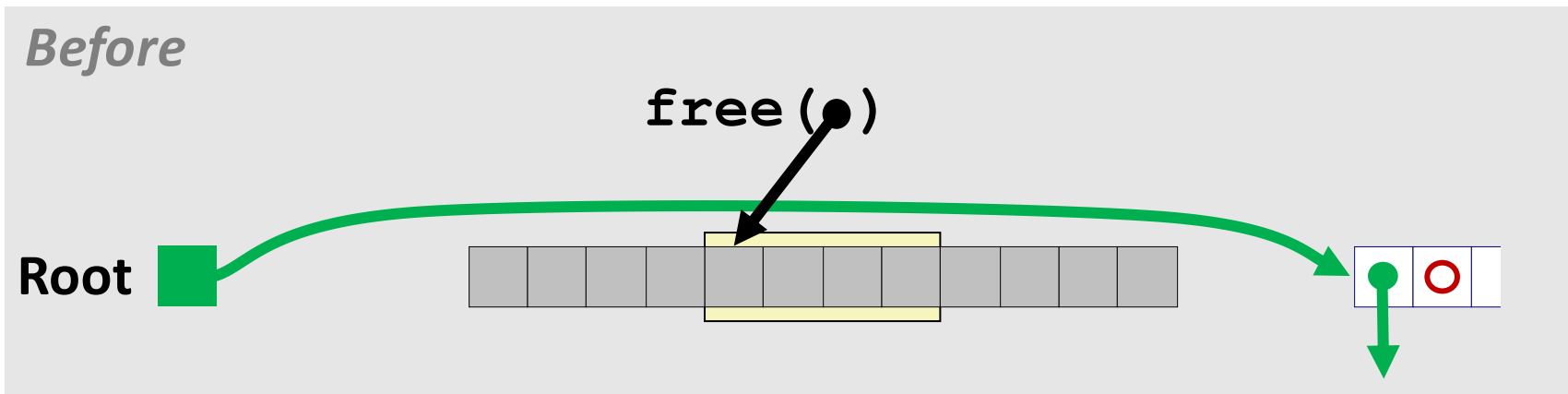

- Insert the freed block at the root of the list

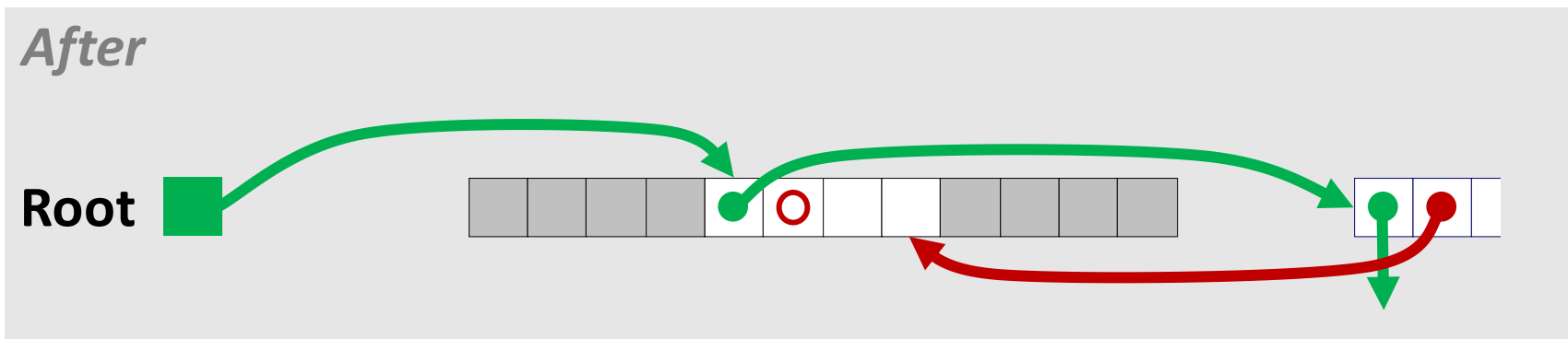

Freeing With a LIFO Policy (Case 2)

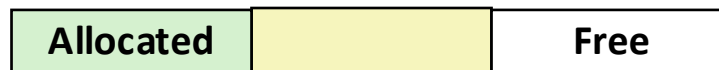

conceptual graphic

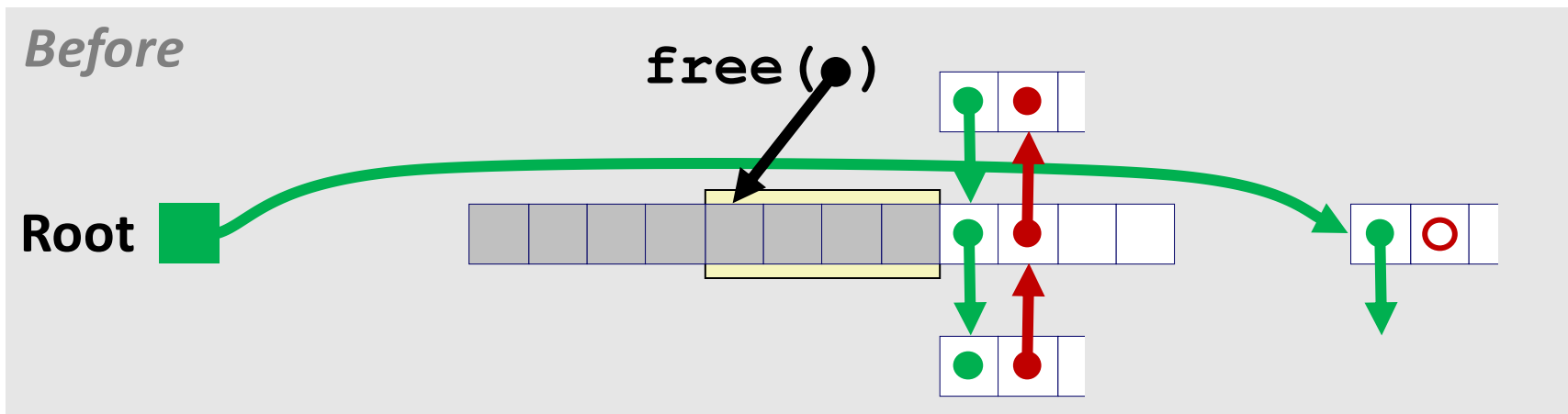

- Splice out adjacent successor block, coalesce both memory blocks, and insert the new block at the root of the list

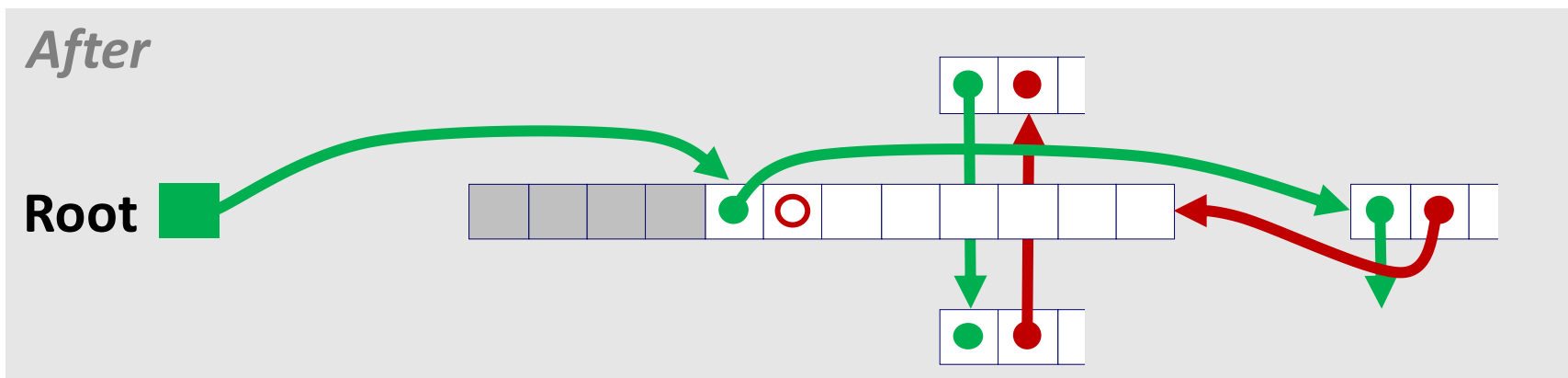

Freeing With a LIFO Policy (Case 3)

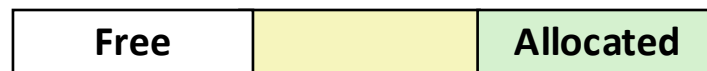

conceptual graphic

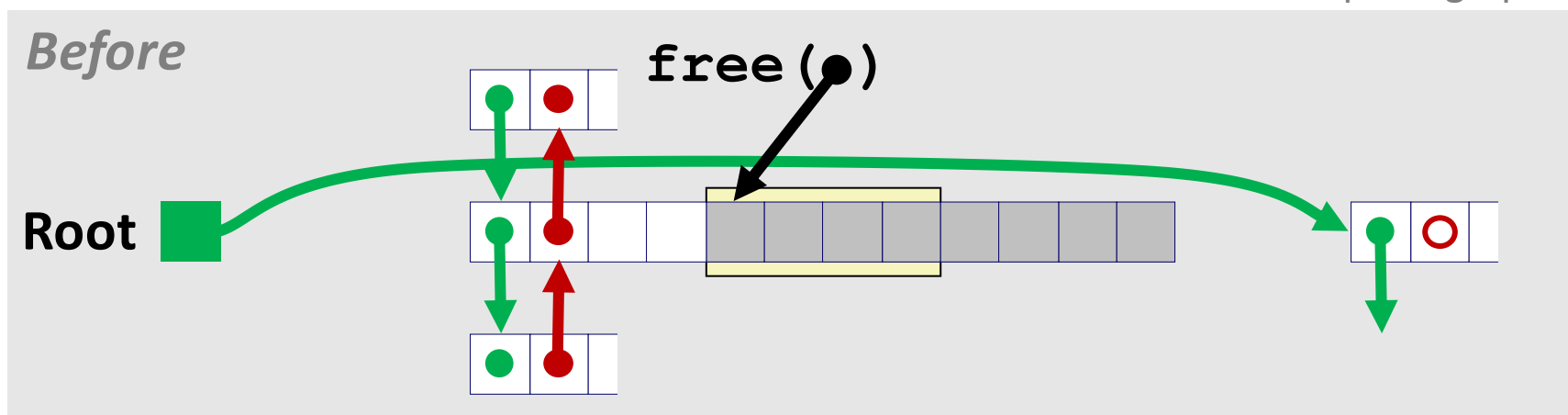

- Splice out adjacent predecessor block, coalesce both memory blocks, and insert the new block at the root of the list

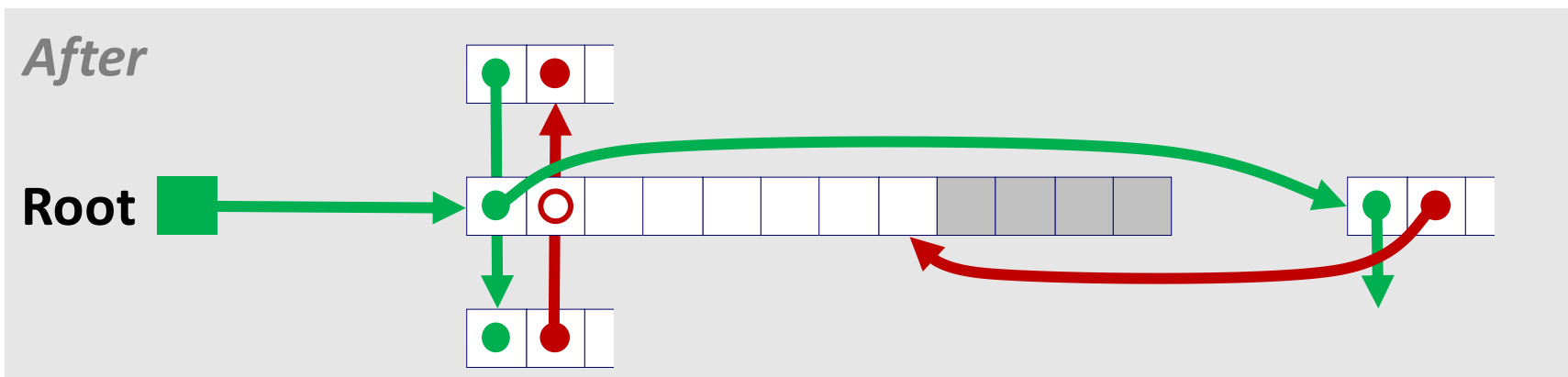

Freeing With a LIFO Policy (Case 4)

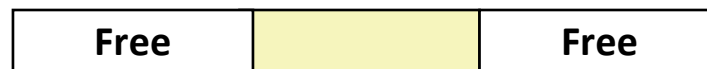

conceptual graphic

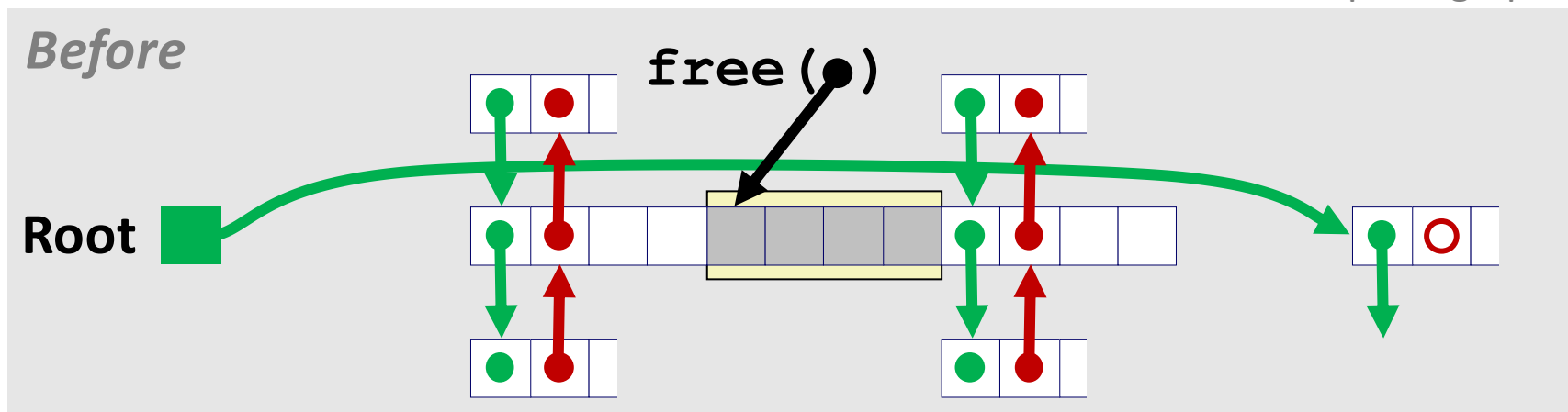

- Splice out adjacent predecessor and successor blocks, coalesce all 3 blocks, and insert the new block at the root of the list

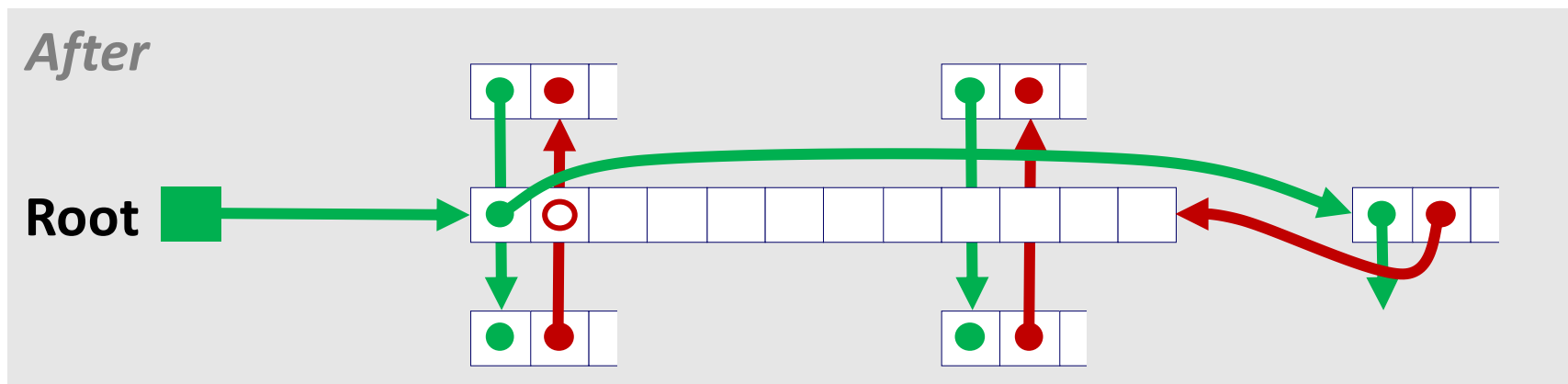

Some Advice: An Implementation Trick

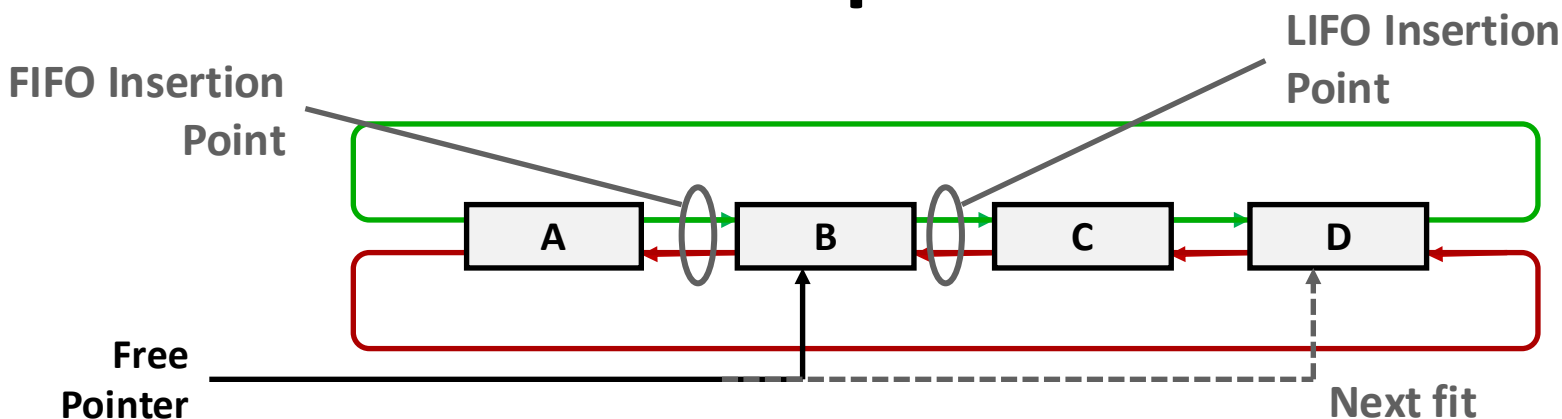

- Use circular, doubly-linked list
- Support multiple approaches with single data structure
- First-fit vs. next-fit
 - Either keep free pointer fixed or move as search list
- LIFO vs. FIFO
 - Insert as next block (LIFO), or previous block (FIFO)

Explicit List Summary

■ Comparison to implicit list:

- Allocate is linear time in number of *free* blocks instead of *all* blocks
 - *Much faster* when most of the memory is full
- Slightly more complicated allocate and free because need to splice blocks in and out of the list
- Some extra space for the links (2 extra words needed for each block)
 - Does this increase internal fragmentation?

Today

- Explicit free lists
- **Segregated free lists**
- Memory-related perils and pitfalls

Keeping Track of Free Blocks

- **Method 1: *Implicit list*** using length—links all blocks

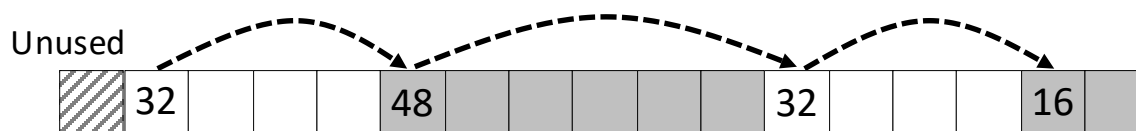

Need to tag each block as allocated/free

- **Method 2: *Explicit list*** among the free blocks using pointers

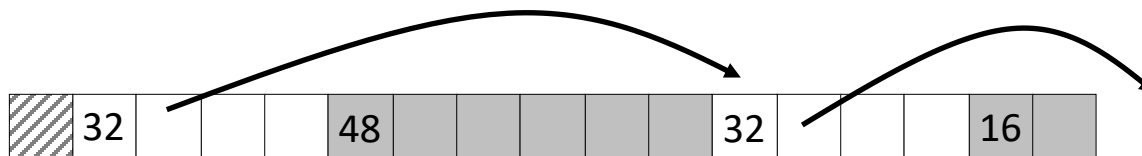

Need space for pointers

- ➔ ■ **Method 3: *Segregated free list***
 - Different free lists for different size classes

- **Method 4: *Blocks sorted by size***
 - Can use a balanced tree (e.g. Red-Black tree) with pointers within each free block, and the length used as a key

Segregated List (Seglist) Allocators

- Each *size class* of blocks has its own free list

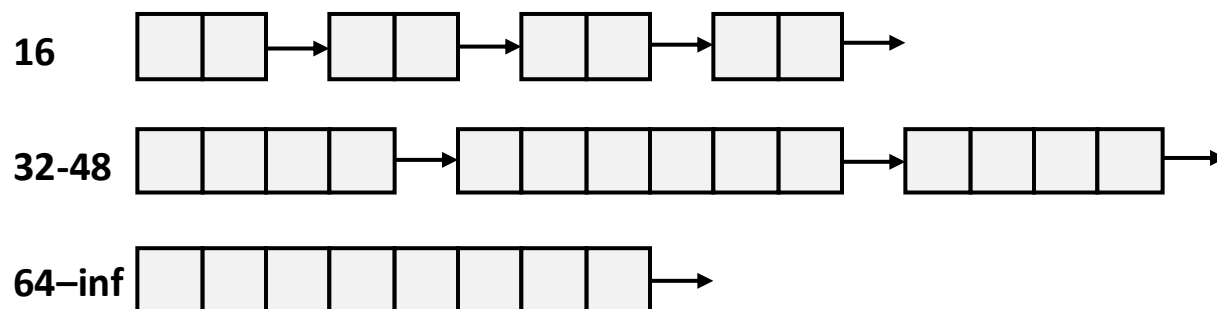

- Often have separate classes for each small size
- For larger sizes: One class for each size $[2^i + 1, 2^{i+1}]$

Seglist Allocator

- Given an array of free lists, each one for some size class

- To allocate a block of size n :
 - Search appropriate free list for block of size $m > n$ (i.e., first fit)
 - If an appropriate block is found:
 - Split block and place fragment on appropriate list
 - If no block is found, try next larger class
 - Repeat until block is found

- If no block is found:
 - Request additional heap memory from OS (using `sbrk()`)
 - Allocate block of n bytes from this new memory
 - Place remainder as a single free block in appropriate size class.

Seglist Allocator (cont.)

- **To free a block:**
 - Coalesce and place on appropriate list

- **Advantages of seglist allocators vs. non-seglist allocators (both with first-fit)**
 - Higher throughput
 - log time for power-of-two size classes vs. linear time
 - Better memory utilization
 - First-fit search of segregated free list approximates a best-fit search of entire heap.
 - Extreme case: Giving each block its own size class is equivalent to best-fit.

More Info on Allocators

- **D. Knuth, *The Art of Computer Programming*, vol 1, 3rd edition, Addison Wesley, 1997**
 - The classic reference on dynamic storage allocation

- **Wilson et al, “*Dynamic Storage Allocation: A Survey and Critical Review*”, Proc. 1995 Int’l Workshop on Memory Management, Kinross, Scotland, Sept, 1995.**
 - Comprehensive survey
 - Available from CS:APP student site (csapp.cs.cmu.edu)

Quiz Time!

Canvas Quiz: Day 15 – Malloc Advanced

Today

- Explicit free lists
- Segregated free lists
- **Memory-related perils and pitfalls**

Memory-Related Perils and Pitfalls

- Dereferencing bad pointers
- Reading uninitialized memory
- Overwriting memory
- Referencing nonexistent variables
- Freeing blocks multiple times
- Referencing freed blocks
- Failing to free blocks

Dereferencing Bad Pointers

■ The classic scanf bug

```
int val;  
  
...  
  
scanf("%d", val);
```

Reading Uninitialized Memory

- Assuming that heap data is initialized to zero

```
/* return y = Ax */
int *matvec(int **A, int *x) {
    int *y = malloc(N*sizeof(int));
    int i, j;

    for (i=0; i<N; i++)
        for (j=0; j<N; j++)
            y[i] += A[i][j]*x[j];
    return y;
}
```

- Can avoid by using `calloc`

Overwriting Memory

- Allocating the (possibly) wrong sized object

```
int **p;  
  
p = malloc(N*sizeof(int));  
  
for (i=0; i<N; i++) {  
    p[i] = malloc(M*sizeof(int));  
}
```

- Can you spot the bug?

Overwriting Memory

■ Off-by-one errors

```
char **p;  
  
p = malloc(N*sizeof(int *));  
  
for (i=0; i<=N; i++) {  
    p[i] = malloc(M*sizeof(int));  
}
```

```
char *p;  
  
p = malloc(strlen(s));  
strcpy(p, s);
```

Overwriting Memory

- Not checking the max string size

```
char s[8];  
int i;  
  
gets(s); /* reads "123456789" from stdin */
```

- Basis for classic buffer overflow attacks

Overwriting Memory

- Misunderstanding pointer arithmetic

```
int *search(int *p, int val) {  
    while (p && *p != val)  
        p += sizeof(int);  
  
    return p;  
}
```

Overwriting Memory

- Referencing a pointer instead of the object it points to

```
int *BinheapDelete(int **binheap, int *size) {
    int *packet;
    packet = binheap[0];
    binheap[0] = binheap[*size - 1];
    *size--;
    Heapify(binheap, *size, 0);
    return(packet);
}
```

- What gets decremented?
 - (See next slide)

Overwriting Memory

- Referencing a pointer instead of the object it points to

```
int *BinheapDelete(int **binheap, int *size) {
    int *packet;
    packet = binheap[0];
    binheap[0] = binheap[*size - 1];
    *size--;
    Heapify(binheap, *size, 0);
    return(packet);
}
```

- Same effect as

- `size--;`

- Rewrite as

- `(*size)--;`

Operators

```
( ) [ ] -> . ++ -- * / %
! ~ ++ -- + - & (type) sizeof
+ -
<< >>
< <= > >=
== !=
&
^
|
&&
||
?:
= += -= *= /= %= &= ^= != <<= >>=
,
```

Associativity

```
left to right
right to left
left to right
left to right
left to right
left to right
left to right
left to right
left to right
right to left
right to left
left to right
```

Referencing Nonexistent Variables

- Forgetting that local variables disappear when a function returns

```
int *foo () {  
    int val;  
  
    return &val;  
}
```

Freeing Blocks Multiple Times

- Nasty!

```
x = malloc(N*sizeof(int));  
    <manipulate x>  
free(x);  
  
y = malloc(M*sizeof(int));  
    <manipulate y>  
free(x);
```

Referencing Freed Blocks

■ Evil!

```
x = malloc(N*sizeof(int));  
  <manipulate x>  
free(x);  
  ...  
y = malloc(M*sizeof(int));  
for (i=0; i<M; i++)  
  y[i] = x[i]++;
```

Failing to Free Blocks (Memory Leaks)

- Slow, long-term killer!

```
foo() {  
    int *x = malloc(N*sizeof(int));  
    ...  
    return;  
}
```

Failing to Free Blocks (Memory Leaks)

■ Freeing only part of a data structure

```
struct list {
    int val;
    struct list *next;
};

foo() {
    struct list *head = malloc(sizeof(struct list));
    head->val = 0;
    head->next = NULL;
    <create and manipulate the rest of the list>
    ...
    free(head);
    return;
}
```

Dealing With Memory Bugs

■ Debugger: `gdb`

- Good for finding bad pointer dereferences
- Hard to detect the other memory bugs

■ Data structure consistency checker

- Runs silently, prints message only on error
- Use as a probe to zero in on error

■ Binary translator: `valgrind`

- Powerful debugging and analysis technique
- Rewrites text section of executable object file
- Checks each individual reference at runtime
 - Bad pointers, overwrites, refs outside of allocated block

■ `glibc malloc` contains checking code

- `setenv MALLOC_CHECK_ 3`

Supplemental slides

Implicit Memory Management: Garbage Collection

- ***Garbage collection***: automatic reclamation of heap-allocated storage—application never has to explicitly free memory

```
void foo() {  
    int *p = malloc(128);  
    return; /* p block is now garbage */  
}
```

- **Common in many dynamic languages:**
 - Python, Ruby, Java, Perl, ML, Lisp, Mathematica
- **Variants (“conservative” garbage collectors) exist for C and C++**
 - However, cannot necessarily collect all garbage

Garbage Collection

- **How does the memory manager know when memory can be freed?**
 - In general we cannot know what is going to be used in the future since it depends on conditionals
 - But we can tell that certain blocks cannot be used if there are no pointers to them
- **Must make certain assumptions about pointers**
 - Memory manager can distinguish pointers from non-pointers
 - All pointers point to the start of a block
 - Cannot hide pointers
(e.g., by coercing them to an `int`, and then back again)

Classical GC Algorithms

- **Mark-and-sweep collection (McCarthy, 1960)**
 - Does not move blocks (unless you also “compact”)
- **Reference counting (Collins, 1960)**
 - Does not move blocks (not discussed)
- **Copying collection (Minsky, 1963)**
 - Moves blocks (not discussed)
- **Generational Collectors (Lieberman and Hewitt, 1983)**
 - Collection based on lifetimes
 - Most allocations become garbage very soon
 - So focus reclamation work on zones of memory recently allocated
- **For more information:**
Jones and Lin, “*Garbage Collection: Algorithms for Automatic Dynamic Memory*”, John Wiley & Sons, 1996.

Memory as a Graph

■ We view memory as a directed graph

- Each block is a node in the graph
- Each pointer is an edge in the graph
- Locations not in the heap that contain pointers into the heap are called **root** nodes (e.g. registers, locations on the stack, global variables)

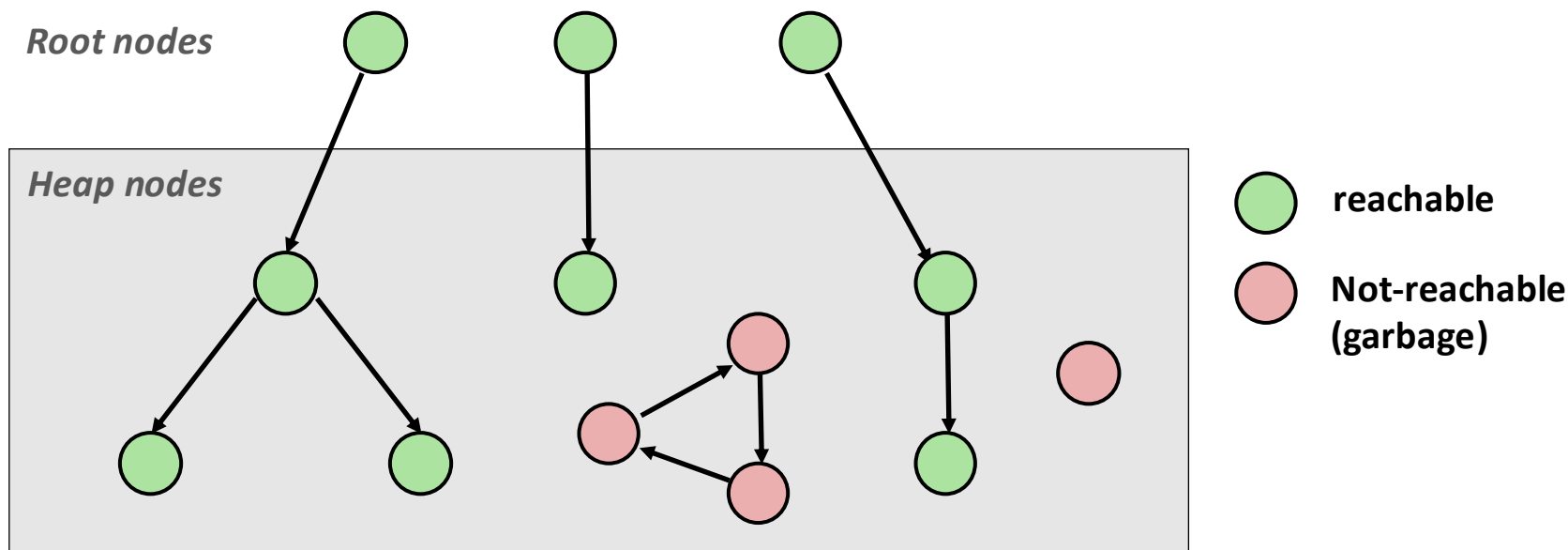

A node (block) is **reachable** if there is a path from any root to that node.

Non-reachable nodes are **garbage** (cannot be needed by the application)

Mark and Sweep Collecting

- Can build on top of malloc/free package
 - Allocate using `malloc` until you “run out of space”
- When out of space:
 - Use extra **mark bit** in the head of each block
 - **Mark:** Start at roots and set mark bit on each reachable block
 - **Sweep:** Scan all blocks and free blocks that are not marked

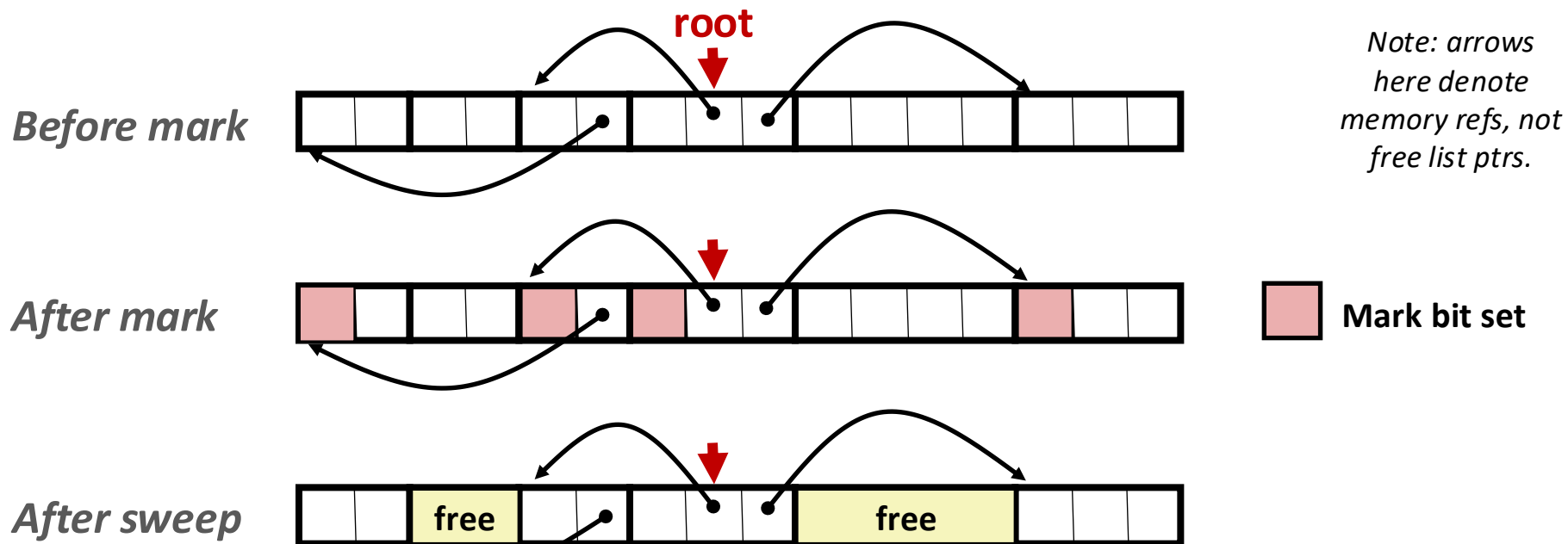

Assumptions For a Simple Implementation

■ Application

- `new (n)` : returns pointer to new block with all locations cleared
- `read (b, i)` : read location `i` of block `b` into register
- `write (b, i, v)` : write `v` into location `i` of block `b`

■ Each block will have a header word

- addressed as `b[-1]`, for a block `b`
- Used for different purposes in different collectors

■ Instructions used by the Garbage Collector

- `is_ptr (p)` : determines whether `p` is a pointer
- `length (b)` : returns the length of block `b`, not including the header
- `get_roots ()` : returns all the roots

Mark and Sweep Pseudocode

Mark using depth-first traversal of the memory graph

```
ptr mark(ptr p) {  
    if (!is_ptr(p)) return;  
    if (markBitSet(p)) return;  
    setMarkBit(p);  
    for (i=0; i < length(p); i++)  
        mark(p[i]);  
    return;  
}
```

Mark and Sweep Pseudocode

Mark using depth-first traversal of the memory graph

```
ptr mark(ptr p) {  
    if (!is_ptr(p)) return;           // if not pointer -> do nothing  
    if (markBitSet(p)) return;  
    setMarkBit(p);  
    for (i=0; i < length(p); i++)  
        mark(p[i]);  
    return;  
}
```

Mark and Sweep Pseudocode

Mark using depth-first traversal of the memory graph

```
ptr mark(ptr p) {  
    if (!is_ptr(p)) return;           // if not pointer -> do nothing  
    if (markBitSet(p)) return;       // if already marked -> do nothing  
    setMarkBit(p);  
    for (i=0; i < length(p); i++)  
        mark(p[i]);  
    return;  
}
```

Mark and Sweep Pseudocode

Mark using depth-first traversal of the memory graph

```
ptr mark(ptr p) {  
    if (!is_ptr(p)) return;           // if not pointer -> do nothing  
    if (markBitSet(p)) return;       // if already marked -> do nothing  
    setMarkBit(p);                   // set the mark bit  
    for (i=0; i < length(p); i++)  
        mark(p[i]);  
    return;  
}
```

Mark and Sweep Pseudocode

Mark using depth-first traversal of the memory graph

```
ptr mark(ptr p) {  
    if (!is_ptr(p)) return;           // if not pointer -> do nothing  
    if (markBitSet(p)) return;       // if already marked -> do nothing  
    setMarkBit(p);                   // set the mark bit  
    for (i=0; i < length(p); i++)    // for each word in p's block  
        mark(p[i]);  
    return;  
}
```

Mark and Sweep Pseudocode

Mark using depth-first traversal of the memory graph

```
ptr mark(ptr p) {  
    if (!is_ptr(p)) return;           // if not pointer -> do nothing  
    if (markBitSet(p)) return;       // if already marked -> do nothing  
    setMarkBit(p);                   // set the mark bit  
    for (i=0; i < length(p); i++)    // for each word in p's block  
        mark(p[i]);                  // make recursive call  
    return;  
}
```

Mark and Sweep Pseudocode

Mark using depth-first traversal of the memory graph

```
ptr mark(ptr p) {
    if (!is_ptr(p)) return;           // if not pointer -> do nothing
    if (markBitSet(p)) return;       // if already marked -> do nothing
    setMarkBit(p);                   // set the mark bit
    for (i=0; i < length(p); i++)    // for each word in p's block
        mark(p[i]);                  // make recursive call
    return;
}
```

Sweep using lengths to find next block

```
ptr sweep(ptr p, ptr end) {
    while (p < end) {                // for entire heap
        if markBitSet(p)
            clearMarkBit();
        else if (allocateBitSet(p))
            free(p);
        p += length(p+1);
    }
}
```

Mark and Sweep Pseudocode

Mark using depth-first traversal of the memory graph

```
ptr mark(ptr p) {  
    if (!is_ptr(p)) return;           // if not pointer -> do nothing  
    if (markBitSet(p)) return;       // if already marked -> do nothing  
    setMarkBit(p);                   // set the mark bit  
    for (i=0; i < length(p); i++)   // for each word in p's block  
        mark(p[i]);                  // make recursive call  
    return;  
}
```

Sweep using lengths to find next block

```
ptr sweep(ptr p, ptr end) {  
    while (p < end) {                // for entire heap  
        if markBitSet(p)             // did we reach this block?  
            clearMarkBit();  
        else if (allocateBitSet(p))  
            free(p);  
        p += length(p+1);  
    }  
}
```

Mark and Sweep Pseudocode

Mark using depth-first traversal of the memory graph

```
ptr mark(ptr p) {
    if (!is_ptr(p)) return;           // if not pointer -> do nothing
    if (markBitSet(p)) return;       // if already marked -> do nothing
    setMarkBit(p);                   // set the mark bit
    for (i=0; i < length(p); i++)    // for each word in p's block
        mark(p[i]);                  // make recursive call
    return;
}
```

Sweep using lengths to find next block

```
ptr sweep(ptr p, ptr end) {
    while (p < end) {                // for entire heap
        if markBitSet(p)              // did we reach this block?
            clearMarkBit();           // yes -> so just clear mark bit
        else if (allocateBitSet(p))
            free(p);
        p += length(p+1);
    }
}
```

Mark and Sweep Pseudocode

Mark using depth-first traversal of the memory graph

```
ptr mark(ptr p) {
    if (!is_ptr(p)) return;           // if not pointer -> do nothing
    if (markBitSet(p)) return;       // if already marked -> do nothing
    setMarkBit(p);                   // set the mark bit
    for (i=0; i < length(p); i++)    // for each word in p's block
        mark(p[i]);                 // make recursive call
    return;
}
```

Sweep using lengths to find next block

```
ptr sweep(ptr p, ptr end) {
    while (p < end) {                // for entire heap
        if markBitSet(p)             // did we reach this block?
            clearMarkBit();          // yes -> so just clear mark bit
        else if (allocateBitSet(p))  // never reached: is it allocated?
            free(p);
        p += length(p+1);
    }
}
```

Mark and Sweep Pseudocode

Mark using depth-first traversal of the memory graph

```

ptr mark(ptr p) {
    if (!is_ptr(p)) return;           // if not pointer -> do nothing
    if (markBitSet(p)) return;       // if already marked -> do nothing
    setMarkBit(p);                   // set the mark bit
    for (i=0; i < length(p); i++)    // for each word in p's block
        mark(p[i]);                  // make recursive call
    return;
}

```

Sweep using lengths to find next block

```

ptr sweep(ptr p, ptr end) {
    while (p < end) {                // for entire heap
        if markBitSet(p)              // did we reach this block?
            clearMarkBit();           // yes -> so just clear mark bit
        else if (allocateBitSet(p))   // never reached: is it allocated?
            free(p);                  // yes -> its garbage, free it
        p += length(p+1);
    }
}

```

Mark and Sweep Pseudocode

Mark using depth-first traversal of the memory graph

```
ptr mark(ptr p) {
    if (!is_ptr(p)) return;           // if not pointer -> do nothing
    if (markBitSet(p)) return;       // if already marked -> do nothing
    setMarkBit(p);                   // set the mark bit
    for (i=0; i < length(p); i++)    // for each word in p's block
        mark(p[i]);                  // make recursive call
    return;
}
```

Sweep using lengths to find next block

```
ptr sweep(ptr p, ptr end) {
    while (p < end) {                // for entire heap
        if markBitSet(p)              // did we reach this block?
            clearMarkBit();           // yes -> so just clear mark bit
        else if (allocateBitSet(p))   // never reached: is it allocated?
            free(p);                  // yes -> its garbage, free it
        p += length(p+1);             // goto next block
    }
}
```

C Pointer Declarations: Test Yourself!

<code>int *p</code>	p is a pointer to int
<code>int *p[13]</code>	p is an array[13] of pointer to int
<code>int *(p[13])</code>	p is an array[13] of pointer to int
<code>int **p</code>	p is a pointer to a pointer to an int
<code>int (*p)[13]</code>	p is a pointer to an array[13] of int
<code>int *f()</code>	f is a function returning a pointer to int
<code>int (*f)()</code>	f is a pointer to a function returning int
<code>int ((*x[3])()) [5]</code>	x is an array[3] of pointers to functions returning pointers to array[5] of ints

C Pointer Declarations: Test Yourself!

<code>int *p</code>	p is a pointer to int
<code>int *p[13]</code>	p is an array[13] of pointer to int
<code>int *(p[13])</code>	p is an array[13] of pointer to int
<code>int **p</code>	p is a pointer to a pointer to an int
<code>int (*p)[13]</code>	p is a pointer to an array[13] of int
<code>int *f()</code>	f is a function returning a pointer to int
<code>int (*f)()</code>	f is a pointer to a function returning int
<code>int (*(x[3])())[5]</code>	x is an array[3] of pointers to functions returning pointers to array[5] of ints
<code>int ((*f())[13])()</code>	f is a function returning ptr to an array[13] of pointers to functions returning int

Parsing: `int (*(*f()) [13]) ()`

`int (*(*f()) [13]) ()`

`f`

`int (*(*f()) [13]) ()`

`f is a function`

`int (*(*f()) [13]) ()`

`f is a function
that returns a ptr`

`int (*(*f()) [13]) ()`

`f is a function
that returns a ptr to an
array of 13`

`int (*(*f()) [13]) ()`

`f is a function that returns
a ptr to an array of 13 ptrs`

`int (*(*f()) [13]) ()`

`f is a function that returns
a ptr to an array of 13 ptrs
to functions returning an int`