



Floating Point

18-213/18-613: Introduction to Computer Systems
3rd Lecture, May 19th, 2022

Announcements

- **Lab 0 and Lab 1 are live (on Autolab)**
- **Homework #1 is live (on canvas)**
- **Autolab updates nightly**
- **Canvas updates nightly**
- **Office Hours and small groups should be organized within a day or so and start next week**
 - Standby for group sign-ups
- **Piazza is live and waiting for you!**
 - Also, feel free to call me, anytime, 412-818-7813

Today: Integers (part-2) & Floats (mostly)

■ Integers

- Representation: unsigned and signed
- Conversion, casting
- Expanding, truncating
- **Addition, negation, multiplication, shifting**

■ Floats

Unsigned Addition

Operands: w bits



True Sum: $w+1$ bits

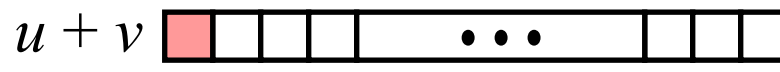

Discard Carry: w bits



■ Standard Addition Function

- Ignores carry output

■ Implements Modular Arithmetic

$$s = \text{UAdd}_w(u, v) = u + v \bmod 2^w$$

unsigned char	1110 1001	E9	223
	+ 1101 0101	+ D5	+ 213
	1 1011 1110	1BE	446
	1011 1110	BE	190

	Hex	Decimal	Binary
0	0	0000	
1	1	0001	
2	2	0010	
3	3	0011	
4	4	0100	
5	5	0101	
6	6	0110	
7	7	0111	
8	8	1000	
9	9	1001	
A	10	1010	
B	11	1011	
C	12	1100	
D	13	1101	
E	14	1110	
F	15	1111	

Visualizing (Mathematical) Integer Addition

■ Integer Addition

- 4-bit integers u, v
- Compute true sum $\text{Add}_4(u, v)$
- Values increase linearly with u and v
- Forms planar surface

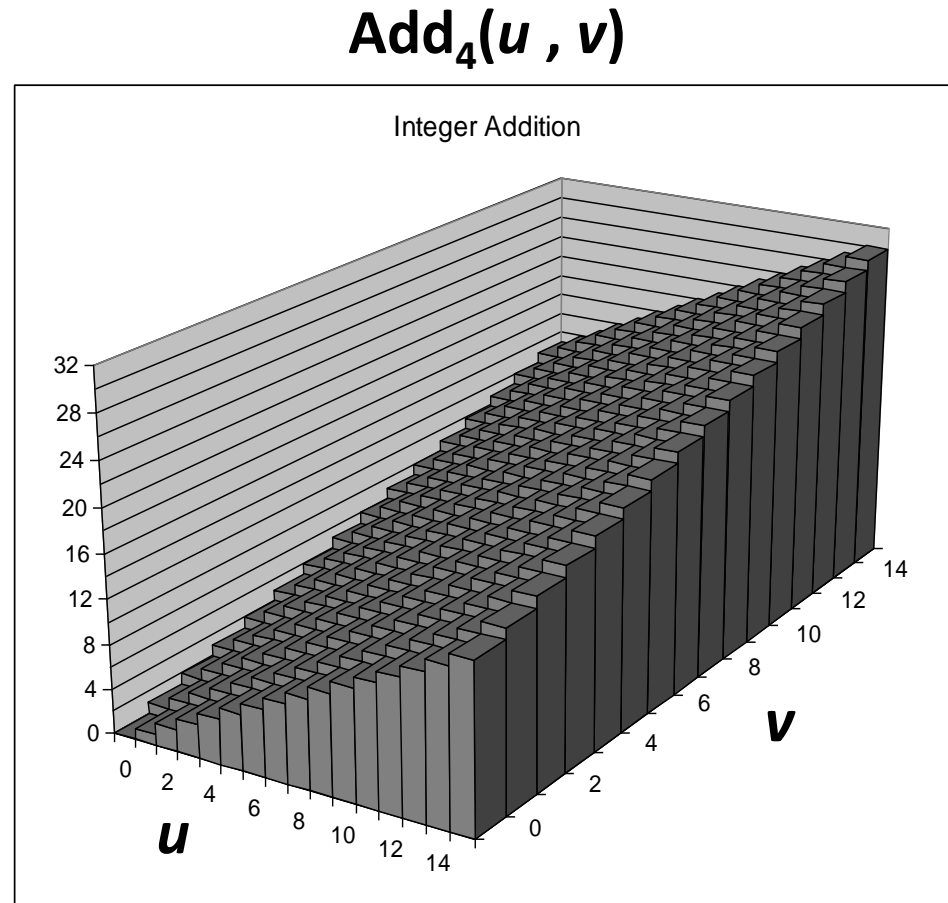

Visualizing Unsigned Addition

■ Wraps Around

- If true sum $\geq 2^w$
- At most once

True Sum

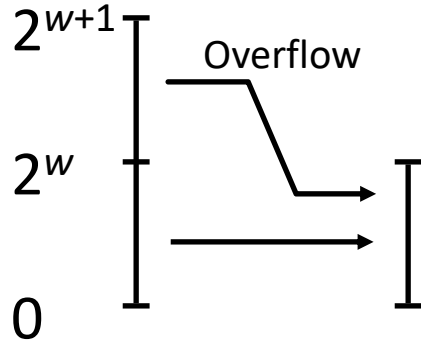

Modular Sum

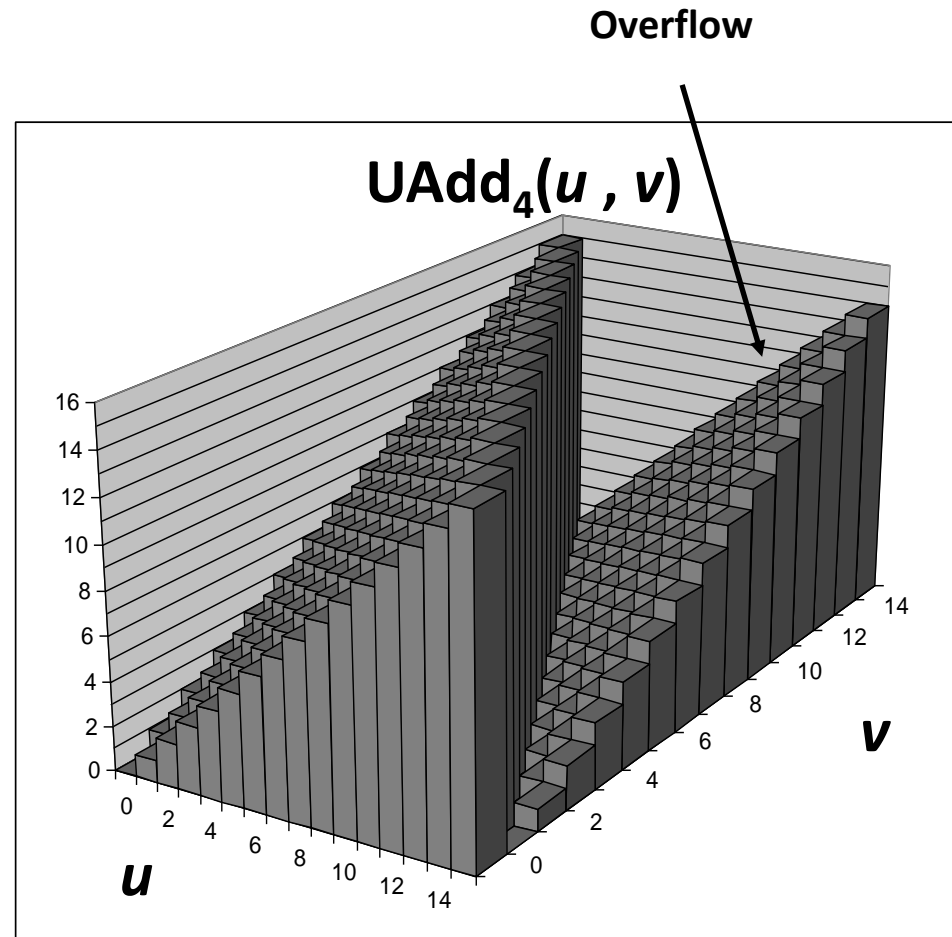

Two's Complement Addition

Operands: w bits

u 

+ v 

True Sum: $w+1$ bits

$u + v$ 

Discard Carry: w bits

$\text{TAdd}_w(u, v)$ 

■ TAdd and UAdd have Identical Bit-Level Behavior

- Signed vs. unsigned addition in C:

```
int s, t, u, v;
```

```
s = (int) ((unsigned) u + (unsigned) v);
```

```
t = u + v
```

- Will give `s == t`

	1110 1001	E9	-23
+	1101 0101	+ D5	+ -43
	1 1011 1110	1BE	-66
	1011 1110	BE	-66

TAdd Overflow

■ Functionality

- True sum requires $w+1$ bits
- Drop off MSB
- Treat remaining bits as 2's comp. integer

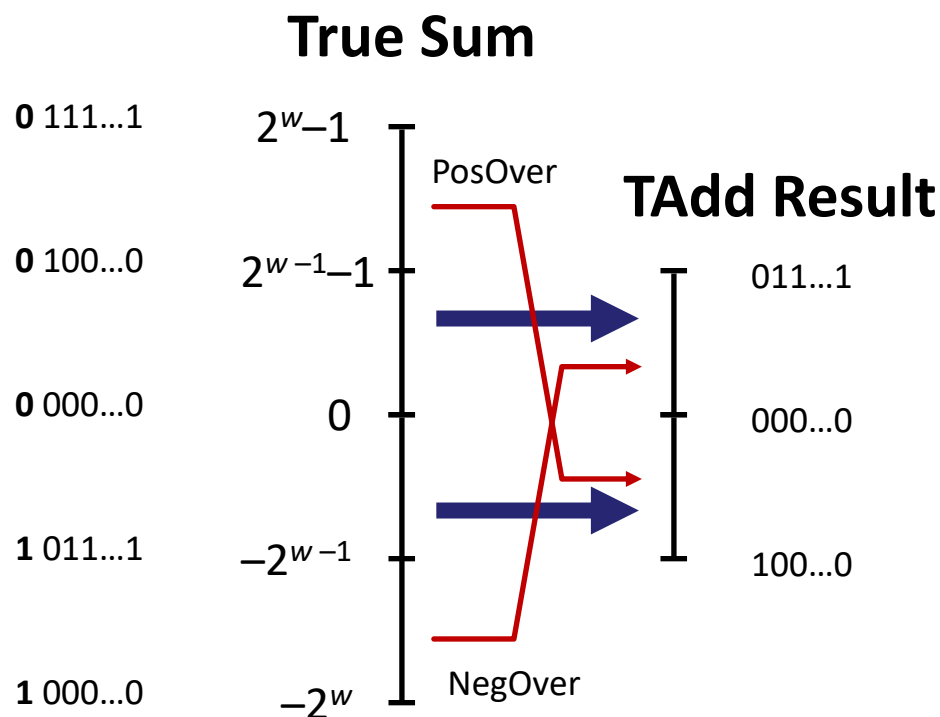

Visualizing 2's Complement Addition

■ Values

- 4-bit two's comp.
- Range from -8 to +7

■ Wraps Around

- If $\text{sum} \geq 2^{w-1}$
 - Becomes negative
 - At most once
- If $\text{sum} < -2^{w-1}$
 - Becomes positive
 - At most once

NegOver

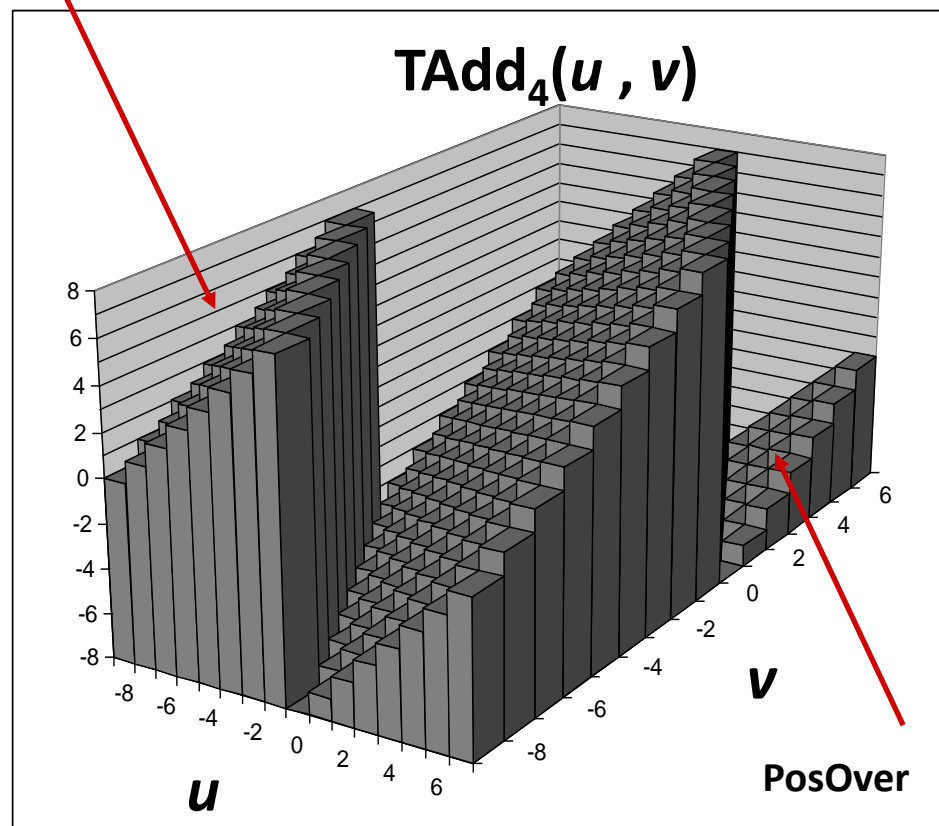

Multiplication

- **Goal: Computing Product of w -bit numbers x, y**

- Either signed or unsigned

- **But, exact results can be bigger than w bits**

- Unsigned: up to $2w$ bits

- Result range: $0 \leq x * y \leq (2^w - 1)^2 = 2^{2w} - 2^{w+1} + 1$

- Two's complement min (negative): Up to $2w-1$ bits

- Result range: $x * y \geq (-2^{w-1}) * (2^{w-1} - 1) = -2^{2w-2} + 2^{w-1}$

- Two's complement max (positive): Up to $2w$ bits, but only for $(TMin_w)^2$

- Result range: $x * y \leq (-2^{w-1})^2 = 2^{2w-2}$

- **So, maintaining exact results...**

- would need to keep expanding word size with each product computed

- is done in software, if needed

- e.g., by “arbitrary precision” arithmetic packages

Unsigned Multiplication in C

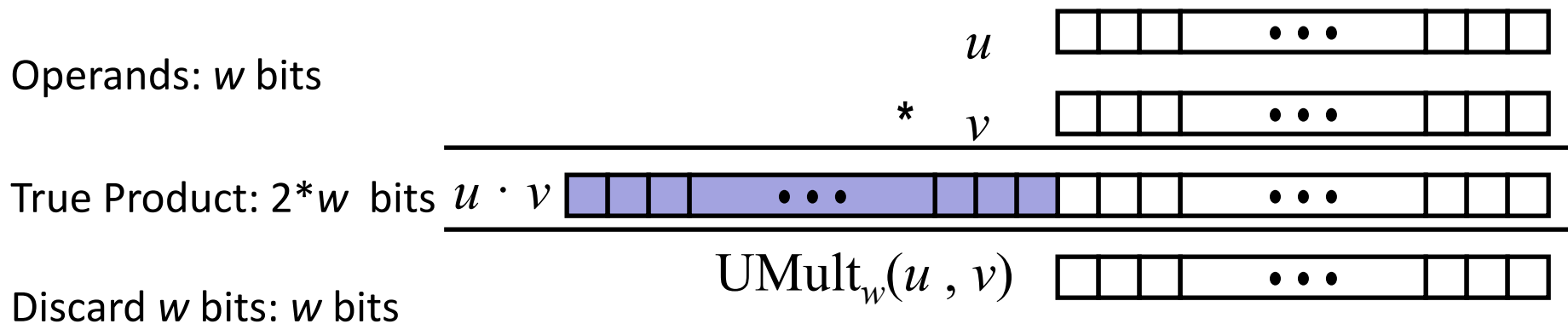

■ Standard Multiplication Function

- Ignores high order w bits

■ Implements Modular Arithmetic

$$\text{UMult}_w(u, v) = u \cdot v \bmod 2^w$$

$$\begin{array}{r}
 1110\ 1001 \\
 * 1101\ 0101 \\
 \hline
 1100\ 0001\ 1101\ 1101 \\
 \hline
 1101\ 1101
 \end{array}$$

$$\begin{array}{r}
 \text{E9} \quad 233 \\
 * \text{D5} \quad 213 \\
 \hline
 \text{C1DD} \quad 49629 \\
 \hline
 \text{DD} \quad 221
 \end{array}$$

Signed Multiplication in C

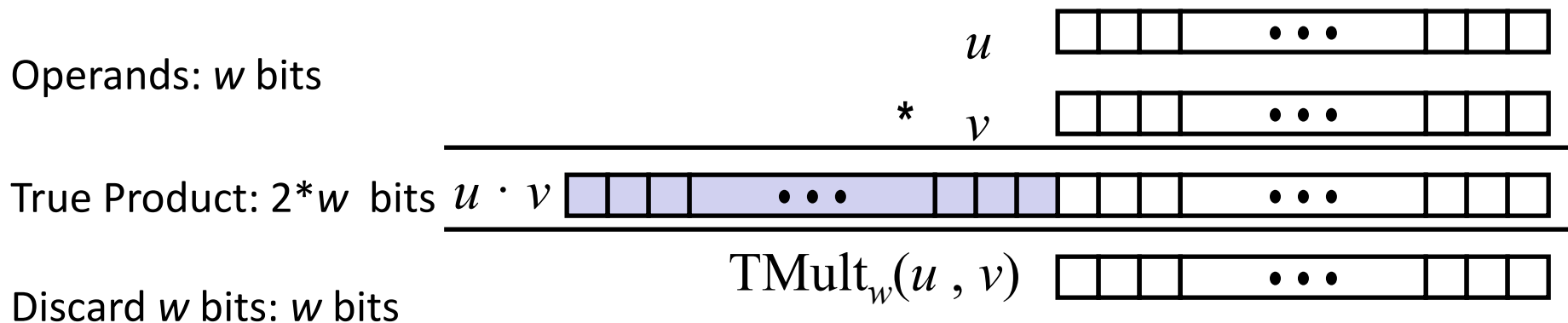

■ Standard Multiplication Function

- Ignores high order w bits
- Some of which are different for signed vs. unsigned multiplication
- Lower bits are the same

	1110 1001	E9	-23
*	1101 0101	* D5	* -43
	0000 0011 1101 1101	03DD	989
	1101 1101	DD	-35

Power-of-2 Multiply with Shift

■ Operation

- $u \ll k$ gives $u * 2^k$
- Both signed and unsigned

Operands: w bits

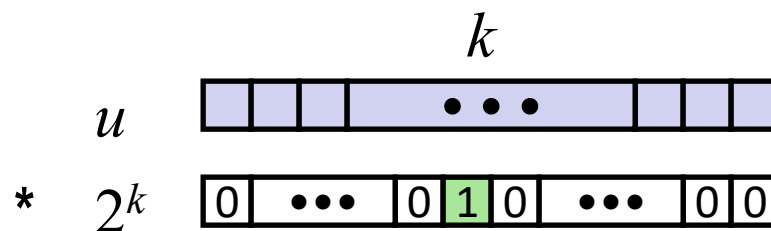

True Product: $w+k$ bits

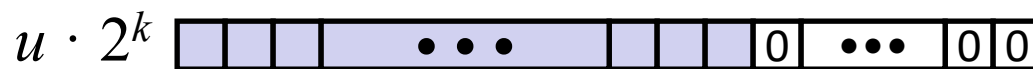

Discard k bits: w bits

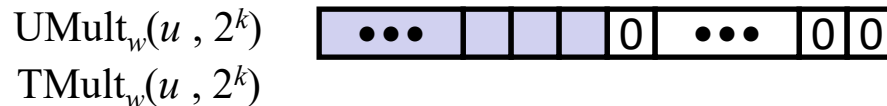

■ Examples

- $u \ll 3 \quad \quad \quad == \quad u * 8$
- $(u \ll 5) - (u \ll 3) == \quad u * 24$
- Most machines shift and add faster than multiply
 - Compiler generates this code automatically

Unsigned Power-of-2 Divide with Shift

■ Quotient of Unsigned by Power of 2

- $u \gg k$ gives $\lfloor u / 2^k \rfloor$
- Uses logical shift

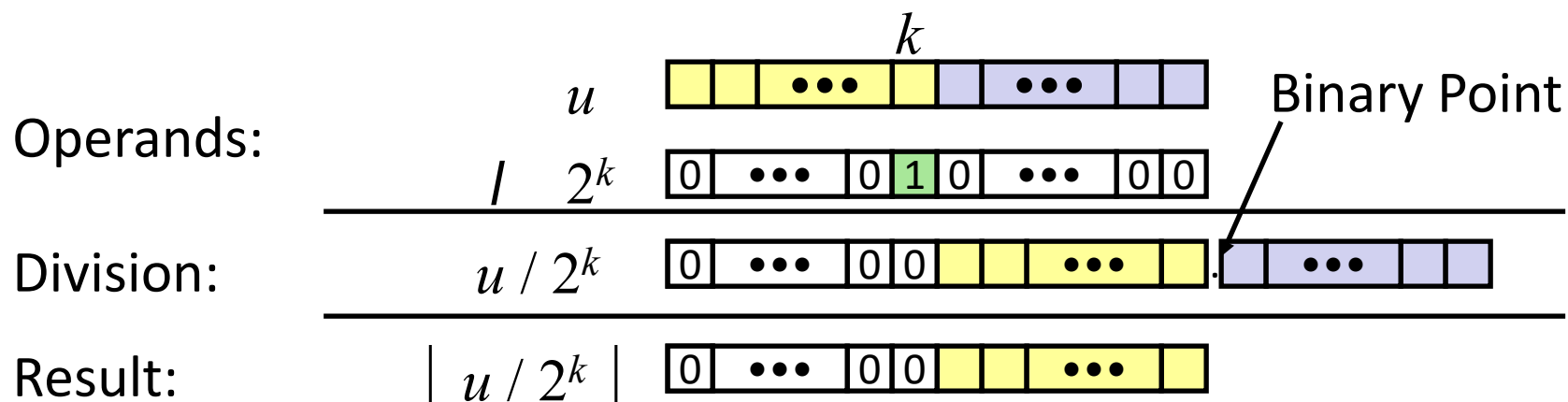

	Division	Computed	Hex	Binary
x	15213	15213	3B 6D	00111011 01101101
x >> 1	7606.5	7606	1D B6	00011101 10110110
x >> 4	950.8125	950	03 B6	00000011 10110110
x >> 8	59.4257813	59	00 3B	00000000 00111011

Signed Power-of-2 Divide with Shift

■ Quotient of Signed by Power of 2

- $x \gg k$ gives $\lfloor x / 2^k \rfloor$
- Uses arithmetic shift
- Rounds wrong direction when $x < 0$

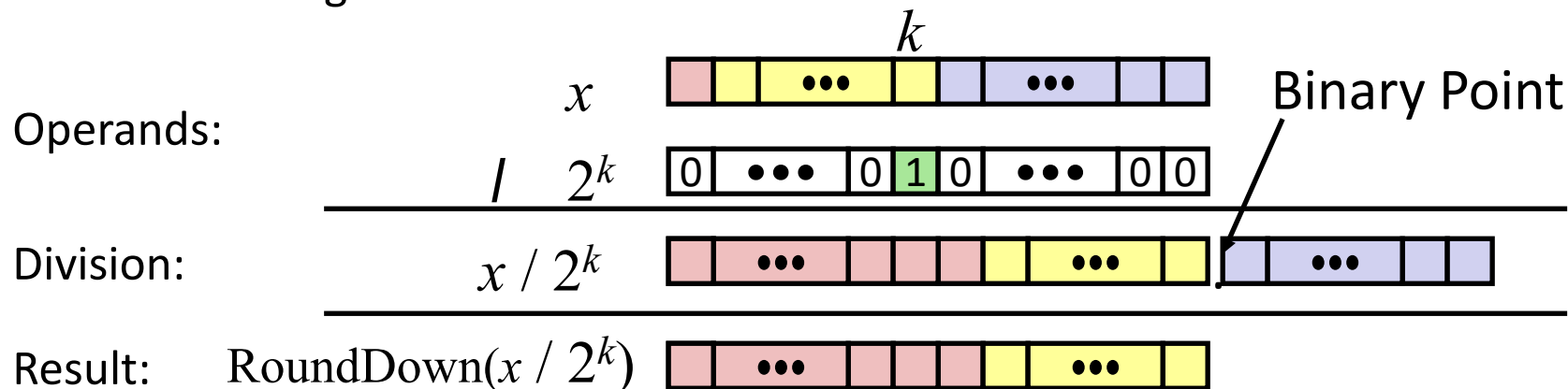

	Division	Computed	Hex	Binary
x	-15213	-15213	C4 93	11000100 10010011
$x \gg 1$	-7606.5	-7607	E2 49	1 1100010 01001001
$x \gg 4$	-950.8125	-951	FC 49	1111 1100 01001001
$x \gg 8$	-59.4257813	-60	FF C4	11111111 11000100

Correct Power-of-2 Divide

■ Quotient of Negative Number by Power of 2

- Want $\lceil \mathbf{x} / 2^k \rceil$ (Round Toward 0)
- Compute as $\lfloor (\mathbf{x} + 2^k - 1) / 2^k \rfloor$
 - In C: $(\mathbf{x} + (1 \ll k) - 1) \gg k$
 - Biases dividend toward 0

Case 1: No rounding (if x is a multiple of 2^k)

$$\rightarrow \lfloor (2^k - 1) / 2^k \rfloor == 0$$

Case 2: Rounding

$$\rightarrow \lfloor (2^k - 1 + (\text{non-zero})) / 2^k \rfloor == 1 \text{ (biasing toward 0)}$$

Today: Floating Point

- **Background: Fractional binary numbers**
- **IEEE floating point standard: Definition**
- **Example and properties**
- **Rounding, addition, multiplication**
- **Floating point in C**
- **Summary**

Fractional binary numbers

- What is 00101.110_2 ?

Fractional Binary Numbers

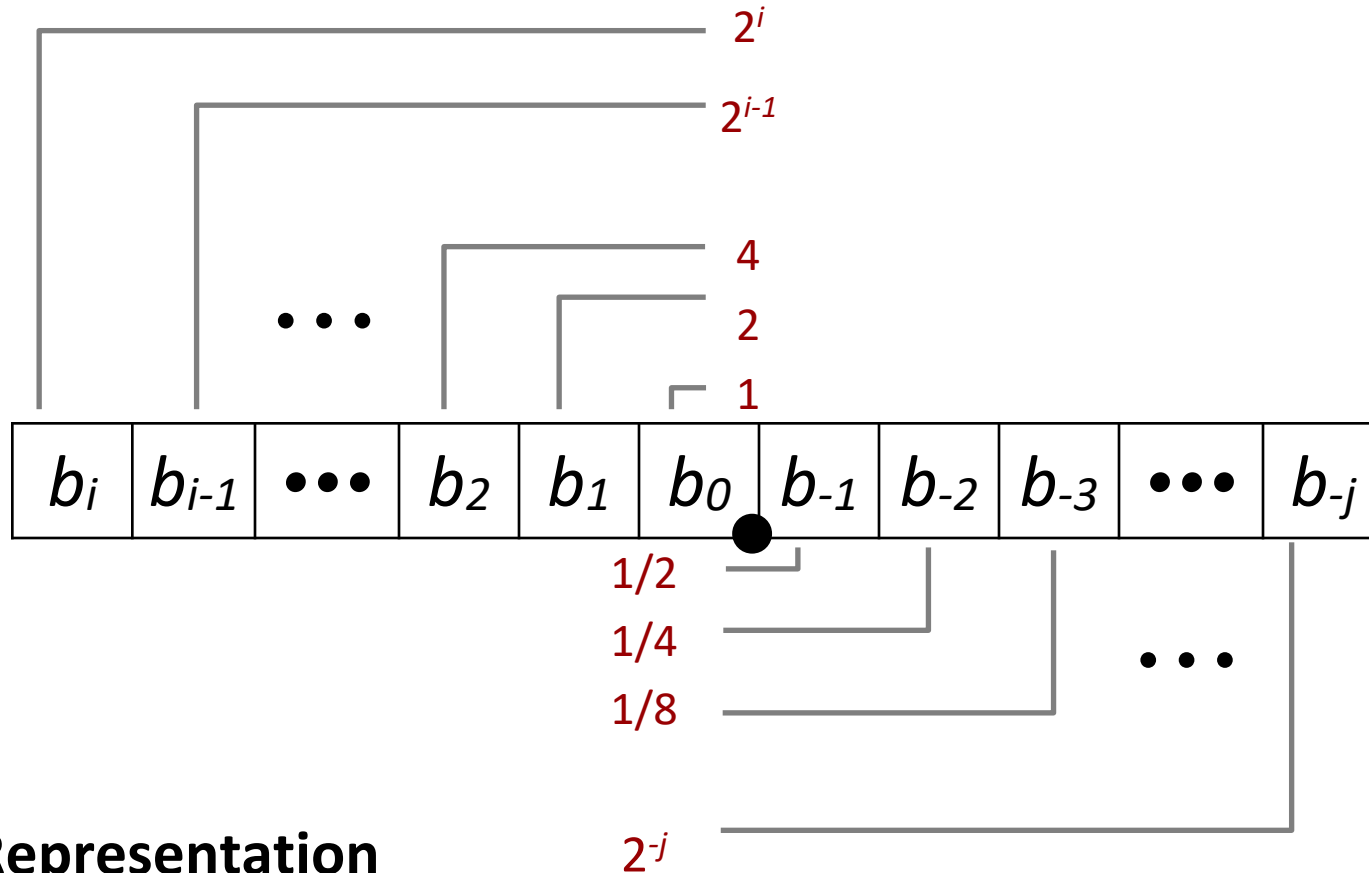

■ Representation

- Bits to right of “binary point” represent fractional powers of 2
- Represents rational number:

$$\sum_{k=-j}^i b_k \times 2^k$$

Fractional Binary Numbers: Examples

Value	Representation	
23	10111.000_2	$= 16 + 4 + 2 + 1$
$11 \frac{1}{2} = \frac{23}{2}$	01011.100_2	$= 8 + 2 + 1 + \frac{1}{2}$
$5 \frac{3}{4} = \frac{23}{4}$	00101.110_2	$= 4 + 1 + \frac{1}{2} + \frac{1}{4}$
$2 \frac{7}{8} = \frac{23}{8}$	00010.111_2	$= 2 + \frac{1}{2} + \frac{1}{4} + \frac{1}{8}$

Observations

- Divide by 2 by shifting right (unsigned)
- Multiply by 2 by shifting left
- Numbers of form $0.111111\dots_2$ are just below 1.0
 - $\frac{1}{2} + \frac{1}{4} + \frac{1}{8} + \dots + \frac{1}{2^i} + \dots \rightarrow 1.0$
 - Use notation $1.0 - \epsilon$

Representable Numbers

■ Limitation #1

- Can only exactly represent numbers of the form $x/2^k$
 - Other rational numbers have repeating bit representations
- Value Representation
 - $1/3$ $0.0101010101 [01] \dots_2$
 - $1/5$ $0.001100110011 [0011] \dots_2$
 - $1/10$ $0.0001100110011 [0011] \dots_2$

■ Limitation #2

- Just one setting of binary point within the w bits
 - Limited range of numbers (very small values? very large?)

(Binary) Scientific Notation

- What are the parts of a number in scientific notation?

$$1.1101101101101_2 \times 2^{13}$$

Significand

Exponent

- What value does the significand always begin with in scientific notation?

Floating Point Representation

■ Numerical Form:

Example:

$$15213_{10} = (-1)^0 \times 1.1101101101101_2 \times 2^{13}$$

$$(-1)^s \cdot M \cdot 2^E$$

- **Sign bit s** determines whether number is negative or positive
- **Significand M** normally a fractional value in range $[1.0, 2.0)$.
- **Exponent E** weights value by power of two

■ Encoding

- MSB s is sign bit s
- **exp** field encodes E (but is not equal to E)
- **frac** field encodes M (but is not equal to M)



Floats can't represent all real numbers!

- **Ariane 5 explodes on maiden voyage: \$500 MILLION dollars lost**
 - 64-bit floating point number assigned to 16-bit integer (1996)
 - Legacy code from Ariane 4 with a lower top speed
 - Causes rocket to get incorrect value of horizontal velocity and crash

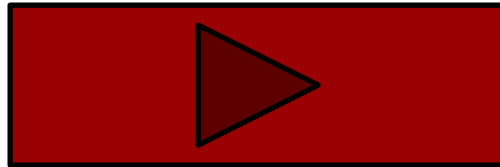

- **Patriot Missile defense system misses scud – 28 people die**
 - System tracks time in tenths of second
 - Converted from integer to floating point number.
 - Accumulated rounding error causes drift. 20% drift over 8 hours.
 - Eventually (on 2/25/1991 system was on for 100 hours) causes range mis-estimation sufficiently large to miss incoming missiles.

Today: Floating Point

- Background: Fractional binary numbers
- **IEEE floating point standard: Definition**
- Example and properties
- Rounding, addition, multiplication
- Floating point in C
- Summary

IEEE Floating Point

■ IEEE Standard 754

- Established in 1985 as uniform standard for floating point arithmetic
 - Before that, many idiosyncratic formats
- Supported by all major CPUs
 - Some specialized CPUs don't implement IEEE 754 in full

■ Driven by numerical concerns

- Nice standards for rounding, overflow, underflow
- Hard to make fast in hardware
 - **Numerical analysts** predominated over **hardware designers** in defining standard

IEEE 754 Floating Point: Goal

■ 6-bit IEEE-like format

- $e = 3$ exponent bits
- $f = 2$ fraction bits
- Bias is $2^{3-1}-1 = 3$

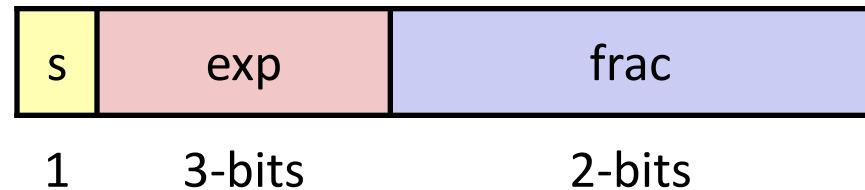

■ Notice how the distribution gets denser toward zero.

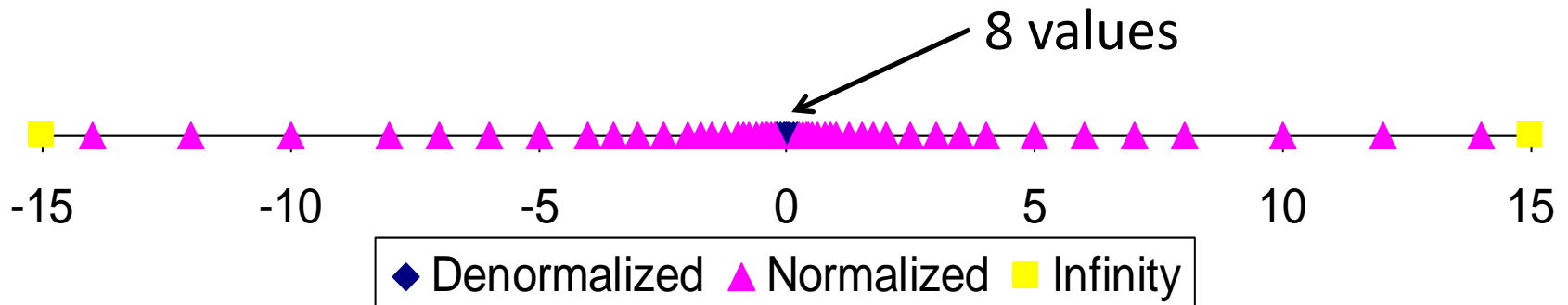

Wide range and precision where it is needed most

Distribution of Values (close-up view)

■ 6-bit IEEE-like format

- $e = 3$ exponent bits
- $f = 2$ fraction bits
- Bias is 3

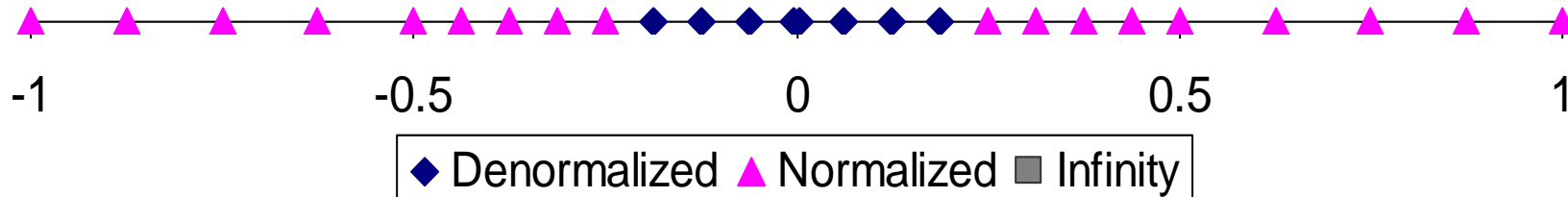
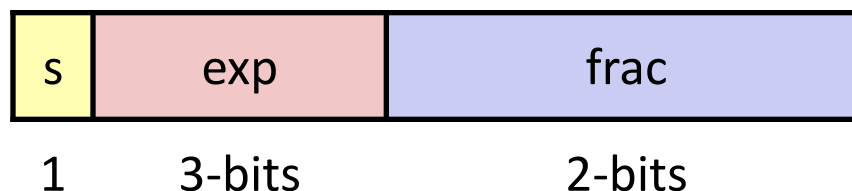

Increasingly bigger steps for large numbers
Dense packing for small numbers

Precision options

- **Single precision: 32 bits**

≈ 7 decimal digits, $10^{\pm 38}$



- **Double precision: 64 bits**

≈ 16 decimal digits, $10^{\pm 308}$



- **Other formats: half precision, quad precision**

Three “kinds” of floating point numbers

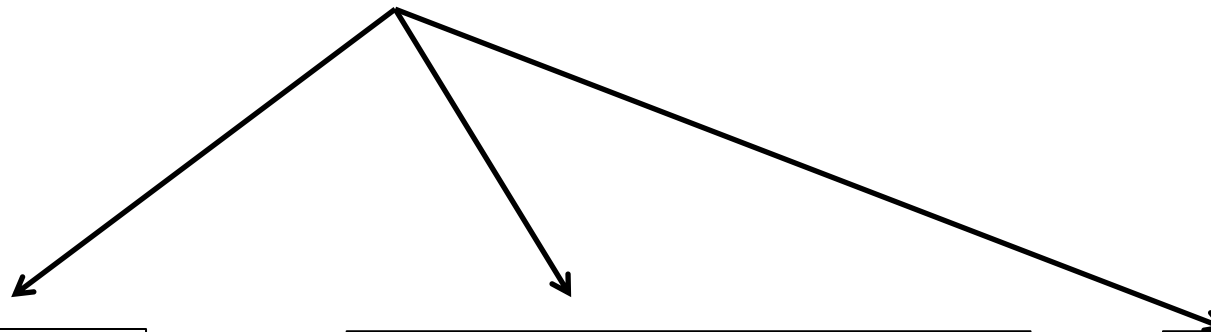

00...00

exp ≠ 0 and exp ≠ 11...11

11...11

denormalized

normalized

special

“Normalized” Values

$$v = (-1)^s M 2^E$$

- **When: $\text{exp} \neq 000\dots0$ and $\text{exp} \neq 111\dots1$**

- **Exponent coded as a *biased* value: $E = \text{exp} - \text{Bias}$**
 - exp : unsigned value of exp field
 - $\text{Bias} = 2^{k-1} - 1$, where k is number of exponent bits
 - Single precision: 127 (**exp**: 1...254, E: -126...127)
 - Double precision: 1023 (**exp**: 1...2046, E: -1022...1023)

- **Significand coded with implied leading 1: $M = 1.\text{xxx}\dots\text{x}_2$**
 - xxx...x: bits of frac field
 - Minimum when **frac**=000...0 ($M = 1.0$)
 - Maximum when **frac**=111...1 ($M = 2.0 - \epsilon$)
 - Get extra leading bit for “free”

Normalized Encoding Example

$$v = (-1)^s M 2^E$$

$$E = \text{exp} - \text{Bias}$$

■ Value: float $F = 15213.0$;

$$\begin{aligned} 15213_{10} &= 11101101101101_2 \\ &= 1.1101101101101_2 \times 2^{13} \end{aligned}$$

■ Significand

$$\begin{aligned} M &= 1.\underline{1101101101101}_2 \\ \text{frac} &= \underline{11011011011010000000000}_2 \end{aligned}$$

■ Exponent

$$\begin{aligned} E &= 13 \\ \text{Bias} &= 127 \\ \text{exp} &= 140 = 10001100_2 \end{aligned}$$

■ Result:

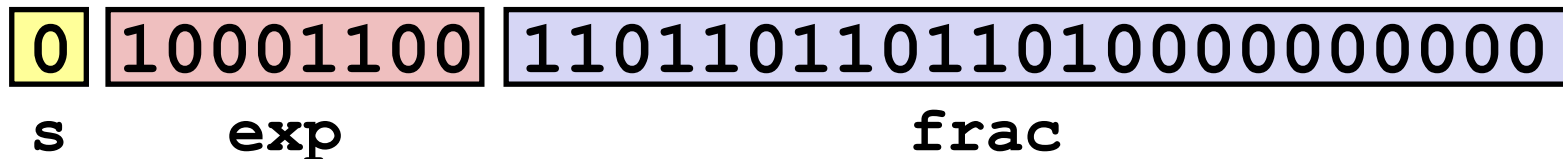

Denormalized Values

$$v = (-1)^s M 2^E$$

$$E = 1 - \text{Bias}$$

- **Condition:** $\text{exp} = 000\dots 0$
- **Exponent value:** $E = 1 - \text{Bias}$ (instead of $\text{exp} - \text{Bias}$) (why?)
- **Significand coded with implied leading 0:** $M = 0.\text{xxx}\dots\text{x}_2$
 - $\text{xxx}\dots\text{x}$: bits of frac
- **Cases**
 - $\text{exp} = 000\dots 0$, $\text{frac} = 000\dots 0$
 - Represents zero value
 - Note distinct values: $+0$ and -0 (why?)
 - $\text{exp} = 000\dots 0$, $\text{frac} \neq 000\dots 0$
 - Numbers closest to 0.0
 - Equispaced

Special Values

- **Condition: $\text{exp} = 111\dots 1$**
- **Case: $\text{exp} = 111\dots 1, \text{frac} = 000\dots 0$**
 - **Represents value ∞ (infinity)**
 - Operation that overflows
 - Both positive and negative
 - E.g., $1.0/0.0 = -1.0/-0.0 = +\infty$, $1.0/-0.0 = -\infty$
- **Case: $\text{exp} = 111\dots 1, \text{frac} \neq 000\dots 0$**
 - **Not-a-Number (NaN)**
 - Represents case when no numeric value can be determined
 - E.g., $\text{sqrt}(-1)$, $\infty - \infty$, $\infty \times 0$

Today: Floating Point

- Background: Fractional binary numbers
- IEEE floating point standard: Definition
- **Example and properties**
- Rounding, addition, multiplication
- Floating point in C
- Summary

C float Decoding Example #1

float: 0xC0A00000

binary: 1100 0000 1010 0000 0000 0000 0000 0000

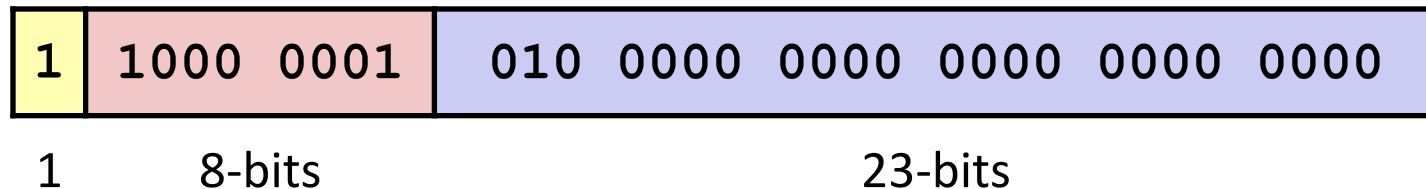

E =

S =

M = 1.

$v = (-1)^S M 2^E =$

$$v = (-1)^S M 2^E$$

$$E = \text{exp} - \text{Bias}$$

Hex	Decimal	Binary
0	0	0000
1	1	0001
2	2	0010
3	3	0011
4	4	0100
5	5	0101
6	6	0110
7	7	0111
8	8	1000
9	9	1001
A	10	1010
B	11	1011
C	12	1100
D	13	1101
E	14	1110
F	15	1111

C float Decoding Example #1

float: 0xC0A00000

binary: 1100 0000 1010 0000 0000 0000 0000 0000

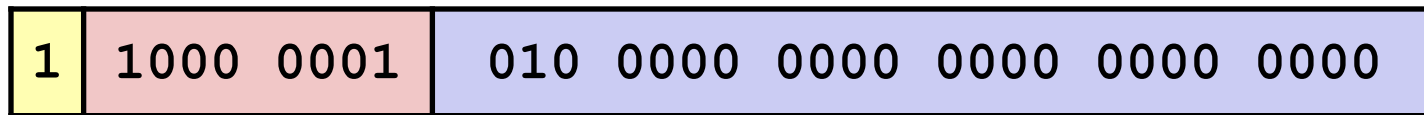

1

8-bits

23-bits

$$E = \text{exp} - \text{Bias} = 129 - 127 = 2 \text{ (decimal)}$$

$S = 1$ -> negative number

$$M = 1.010\ 0000\ 0000\ 0000\ 0000\ 0000$$

$$= 1 + 1/4 = 1.25$$

$$v = (-1)^S M 2^E = (-1)^1 * 1.25 * 2^2 = -5$$

$$v = (-1)^S M 2^E$$

$$E = \text{exp} - \text{Bias}$$

$$\text{Bias} = 2^{k-1} - 1 = 127$$

Hex
Decimal
Binary

0	0	0000
1	1	0001
2	2	0010
3	3	0011
4	4	0100
5	5	0101
6	6	0110
7	7	0111
8	8	1000
9	9	1001
A	10	1010
B	11	1011
C	12	1100
D	13	1101
E	14	1110
F	15	1111

C float Decoding Example #2

$$v = (-1)^S M 2^E$$

$$E = 1 - \text{Bias}$$

float: 0x001C0000

binary: 0000 0000 0001 1100 0000 0000 0000 0000

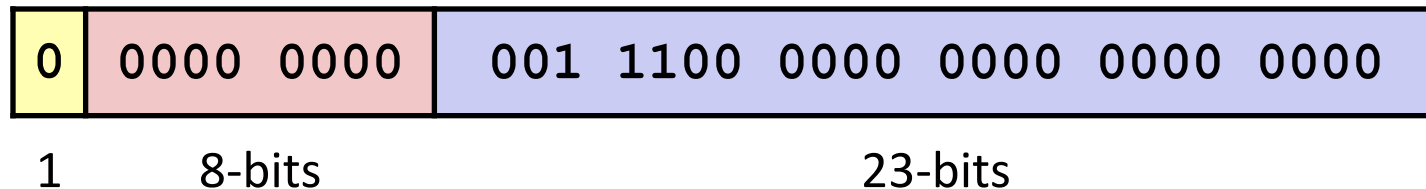

E =

S =

M = 0 .

$$v = (-1)^S M 2^E =$$

Hex	Decimal	Binary
0	0	0000
1	1	0001
2	2	0010
3	3	0011
4	4	0100
5	5	0101
6	6	0110
7	7	0111
8	8	1000
9	9	1001
A	10	1010
B	11	1011
C	12	1100
D	13	1101
E	14	1110
F	15	1111

C float Decoding Example #2

float: 0x001C0000

binary: 0000 0000 0001 1100 0000 0000 0000 0000

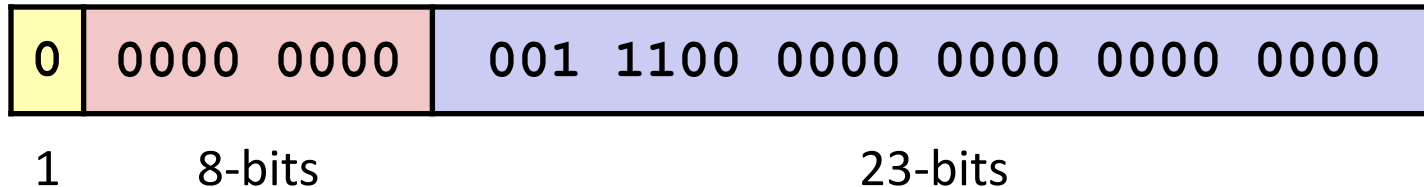

$$E = 1 - \text{Bias} = 1 - 127 = -126 \text{ (decimal)}$$

$S = 0$ -> positive number

$$M = 0.001\ 1100\ 0000\ 0000\ 0000\ 0000$$

$$= 1/8 + 1/16 + 1/32 = 7/32 = 7 * 2^{-5}$$

$$v = (-1)^S M 2^E = (-1)^0 * 7 * 2^{-5} * 2^{-126} = 7 * 2^{-131}$$

$$\approx 2.571393892 \times 10^{-39}$$

$$v = (-1)^S M 2^E$$

$$E = 1 - \text{Bias}$$

$$\text{Bias} = 2^{k-1} - 1 = 127$$

Hex	Decimal	Binary
0	0	0000
1	1	0001
2	2	0010
3	3	0011
4	4	0100
5	5	0101
6	6	0110
7	7	0111
8	8	1000
9	9	1001
A	10	1010
B	11	1011
C	12	1100
D	13	1101
E	14	1110
F	15	1111

Visualization: Floating Point Encodings

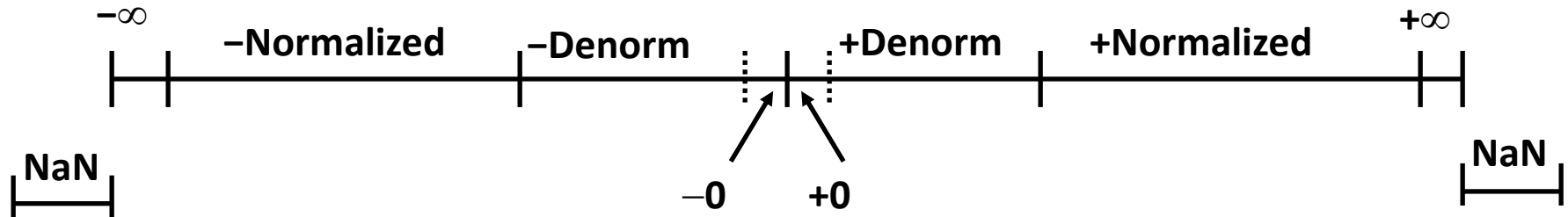

Special Properties of the IEEE Encoding

■ FP Zero Same as Integer Zero

- All bits = 0

■ Can (Almost) Use Unsigned Integer Comparison

- Must first compare sign bits
- Must consider $-0 = 0$
- NaNs problematic
 - Will be greater than any other values
 - What should comparison yield? The answer is complicated.
- Otherwise OK
 - Denorm vs. normalized
 - Normalized vs. infinity

Interesting Numbers

{single, double}

<i>Description</i>	<i>exp</i>	<i>frac</i>	<i>Numeric Value</i>
■ Zero	00...00	00...00	0.0
■ Smallest Pos. Denorm.	00...00	00...01	$2^{-\{23,52\}} \times 2^{-\{126,1022\}}$
<ul style="list-style-type: none"> ■ Single $\approx 1.4 \times 10^{-45}$ ■ Double $\approx 4.9 \times 10^{-324}$ 			
■ Largest Denormalized	00...00	11...11	$(1.0 - \epsilon) \times 2^{-\{126,1022\}}$
<ul style="list-style-type: none"> ■ Single $\approx 1.18 \times 10^{-38}$ ■ Double $\approx 2.2 \times 10^{-308}$ 			
■ Smallest Pos. Normalized	00...01	00...00	$1.0 \times 2^{-\{126,1022\}}$
<ul style="list-style-type: none"> ■ Just larger than largest denormalized 			
■ One	01...11	00...00	1.0
■ Largest Normalized	11...10	11...11	$(2.0 - \epsilon) \times 2^{\{127,1023\}}$
<ul style="list-style-type: none"> ■ Single $\approx 3.4 \times 10^{38}$ ■ Double $\approx 1.8 \times 10^{308}$ 			

Dynamic Range (s=0 only)

$$v = (-1)^s M 2^E$$

norm: E = exp - Bias
denorm: E = 1 - Bias

	s	exp	frac	E	Value	
Denormalized numbers	0	0000	000	-6	0	
	0	0000	001	-6	$1/8 * 1/64 = 1/512$	closest to zero
	0	0000	010	-6	$2/8 * 1/64 = 2/512$	$(-1)^0 (0+1/4) * 2^{-6}$
	...					
	0	0000	110	-6	$6/8 * 1/64 = 6/512$	
	0	0000	111	-6	$7/8 * 1/64 = 7/512$	largest denorm
	0	0001	000	-6	$8/8 * 1/64 = 8/512$	smallest norm
	0	0001	001	-6	$9/8 * 1/64 = 9/512$	$(-1)^0 (1+1/8) * 2^{-6}$
	...					
	0	0110	110	-1	$14/8 * 1/2 = 14/16$	
Normalized numbers	0	0110	111	-1	$15/8 * 1/2 = 15/16$	closest to 1 below
	0	0111	000	0	$8/8 * 1 = 1$	
	0	0111	001	0	$9/8 * 1 = 9/8$	closest to 1 above
	0	0111	010	0	$10/8 * 1 = 10/8$	
	...					
	0	1110	110	7	$14/8 * 128 = 224$	
	0	1110	111	7	$15/8 * 128 = 240$	largest norm
	0	1111	000	n/a	inf	

Quiz Time!

Canvas > Day 3 (Floating Point)

Today: Floating Point

- Background: Fractional binary numbers
- IEEE floating point standard: Definition
- Example and properties
- **Rounding, addition, multiplication**
- Floating point in C
- Summary

Floating Point Operations: Basic Idea

■ $x +_f y = \text{Round}(x + y)$

■ $x \times_f y = \text{Round}(x \times y)$

■ Basic idea

- First **compute exact result**
- Make it fit into desired precision
 - Possibly overflow if exponent too large
 - Possibly **round to fit into frac**

Rounding

■ Rounding Modes (illustrate with \$ rounding)

	\$1.40	\$1.60	\$1.50	\$2.50	-\$1.50
■ Towards zero	\$1 ↓	\$1 ↓	\$1 ↓	\$2 ↓	-\$1 ↑
■ Round down ($-\infty$)	\$1 ↓	\$1 ↓	\$1 ↓	\$2 ↓	-\$2 ↓
■ Round up ($+\infty$)	\$2 ↑	\$2 ↑	\$2 ↑	\$3 ↑	-\$1 ↑
■ Nearest Even* (default)	\$1 ↓	\$2 ↑	\$2 ↑	\$2 ↓	-\$2 ↓

*Round to nearest, but if half-way in-between then round to nearest even

Closer Look at Round-To-Even

■ Default Rounding Mode

- Hard to get any other kind without dropping into assembly
 - C99 has support for rounding mode management
- All others are statistically biased
 - Sum of set of positive numbers will consistently be over- or under-estimated

■ Applying to Other Decimal Places / Bit Positions

- When exactly halfway between two possible values
 - Round so that least significant digit is even
- E.g., round to nearest hundredth

7.8949999	7.89	(Less than half way)
7.8950001	7.90	(Greater than half way)
7.8950000	7.90	(Half way—round up)
7.8850000	7.88	(Half way—round down)

Rounding Binary Numbers

■ Binary Fractional Numbers

- “Even” when least significant bit is 0
- “Half way” when bits to right of rounding position = 100...₂

■ Examples

- Round to nearest 1/4 (2 bits right of binary point)

Value	Binary	Rounded	Action	Rounded Value
2 3/32	10.00 011 ₂	10.00 ₂	(<1/2—down)	2
2 3/16	10.00 110 ₂	10.01 ₂	(>1/2—up)	2 1/4
2 7/8	10.11 100 ₂	11.00 ₂	(1/2—up)	3
2 5/8	10.10 100 ₂	10.10 ₂	(1/2—down)	2 1/2

Rounding

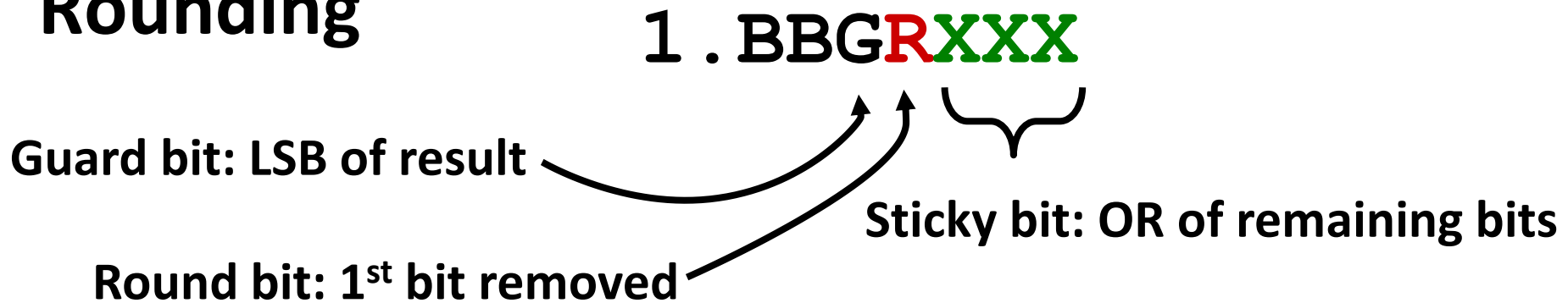

■ Round up conditions

- Round = 1, Sticky = 1 \rightarrow > 0.5
- Guard = 1, Round = 1, Sticky = 0 \rightarrow Round to even

<i>Fraction</i>	<i>GRS</i>	<i>Incr?</i>	<i>Rounded</i>
1.0000000	000	N	1.000
1.1010000	100	N	1.101
1.0001000	010	N	1.000
1.0011000	110	Y	1.010
1.0001010	011	Y	1.001
1.1111100	111	Y	10.000

FP Multiplication

■ $(-1)^{s1} M1 2^{E1} \times (-1)^{s2} M2 2^{E2}$

■ **Exact Result:** $(-1)^s M 2^E$

- Sign s : $s1 \wedge s2$
- Significand M : $M1 \times M2$
- Exponent E : $E1 + E2$

■ Fixing

- If $M \geq 2$, shift M right, increment E
- If E out of range, overflow
- Round M to fit **frac** precision

■ Implementation

- Biggest chore is multiplying significands

$$\begin{aligned}
 \text{4 bit significand: } 1.010 * 2^2 \times 1.110 * 2^3 &= 10.0011 * 2^5 \\
 &= 1.00011 * 2^6 = 1.001 * 2^6
 \end{aligned}$$

Floating Point Addition

$$\blacksquare (-1)^{s1} M1 2^{E1} + (-1)^{s2} M2 2^{E2}$$

- Assume $E1 > E2$

$$\blacksquare \text{Exact Result: } (-1)^s M 2^E$$

- Sign s , significand M :
 - Result of signed align & add
- Exponent E : $E1$

Fixing

- If $M \geq 2$, shift M right, increment E
- if $M < 1$, shift M left k positions, decrement E by k
- Overflow if E out of range
- Round M to fit **frac** precision

Get binary points lined up

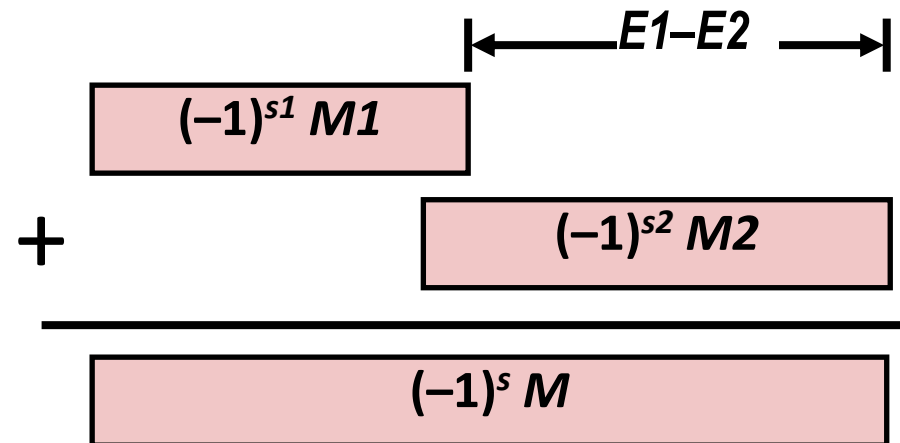

$$1.010 * 2^2 + 1.110 * 2^3 = (0.1010 + 1.1100) * 2^3$$

$$= 10.0110 * 2^3 = 1.00110 * 2^4 = 1.010 * 2^4$$

Mathematical Properties of FP Add

■ Compare to those of Abelian Group

- Closed under addition? *Yes*
 - But may generate infinity or NaN
- Commutative? *Yes*
- Associative? *No*
 - Overflow and inexactness of rounding
 - $(3.14+1e10) - 1e10 = 0$, $3.14+(1e10-1e10) = 3.14$
- 0 is additive identity? *Yes*
- Every element has additive inverse? *Almost*
 - Yes, except for infinities & NaNs

■ Monotonicity

- $a \geq b \Rightarrow a+c \geq b+c$ *Almost*
 - Except for infinities & NaNs

Mathematical Properties of FP Mult

■ Compare to Commutative Ring

- Closed under multiplication? *Yes*
 - But may generate infinity or NaN
- Multiplication Commutative? *Yes*
- Multiplication is Associative? *No*
 - Possibility of overflow, inexactness of rounding
 - Ex: $(1e20 * 1e20) * 1e-20 = \text{inf}$, $1e20 * (1e20 * 1e-20) = 1e20$
- 1 is multiplicative identity? *Yes*
- Multiplication distributes over addition? *No*
 - Possibility of overflow, inexactness of rounding
 - $1e20 * (1e20 - 1e20) = 0.0$, $1e20 * 1e20 - 1e20 * 1e20 = \text{NaN}$

■ Monotonicity

- $a \geq b \ \& \ c \geq 0 \Rightarrow a * c \geq b * c$ *Almost*
 - Except for infinities & NaNs

Today: Floating Point

- Background: Fractional binary numbers
- IEEE floating point standard: Definition
- Example and properties
- Rounding, addition, multiplication
- **Floating point in C**
- Summary

Floating Point in C

■ C Guarantees Two Levels

- `float` single precision
- `double` double precision

■ Conversions/Casting

- Casting between `int`, `float`, and `double` changes bit representation
- `double/float` → `int`
 - Truncates fractional part
 - Like rounding toward zero
 - Not defined when out of range or NaN: Generally sets to TMin
- `int` → `double`
 - Exact conversion, as long as `int` has ≤ 53 bit word size
- `int` → `float`
 - Will round according to rounding mode

Floating Point Puzzles

■ For each of the following C expressions, either:

- Argue that it is true for all argument values
- Explain why not true

```
int x = ...;
float f = ...;
double d = ...;
```

Assume neither
d nor **f** is NaN

- `x == (int)(float) x`
- `x == (int)(double) x`
- `f == (float)(double) f`
- `d == (double)(float) d`
- `f == -(-f);`
- `2/3 == 2/3.0`
- `d < 0.0 ⇒ ((d*2) < 0.0)`
- `d > f ⇒ -f > -d`
- `d * d >= 0.0`
- `(d+f) - d == f`

✗

✓

✓

✗

✓

✗

✓

✓

✓

✗

Summary

- IEEE Floating Point has clear mathematical properties
- Represents numbers of form $M \times 2^E$
- One can reason about operations independent of implementation
 - As if computed with perfect precision and then rounded
- Not the same as real arithmetic
 - Violates associativity/distributivity
 - Makes life difficult for compilers & serious numerical applications programmers

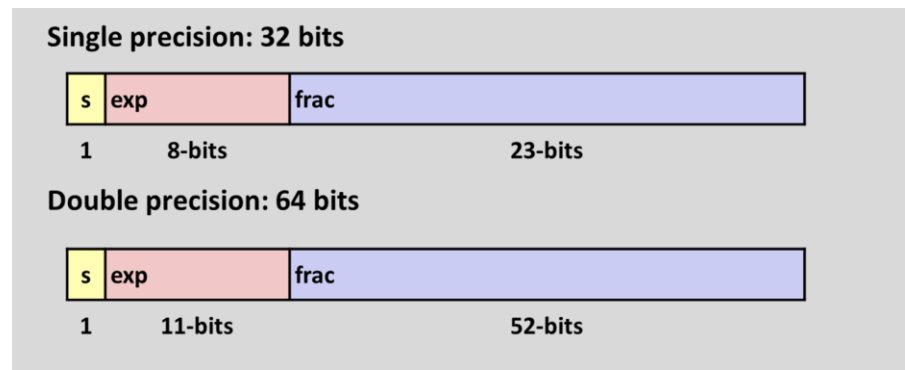

Additional Slides

Creating Floating Point Number

■ Steps

- Normalize to have leading 1
- Round to fit within fraction
- Postnormalize to deal with effects of rounding

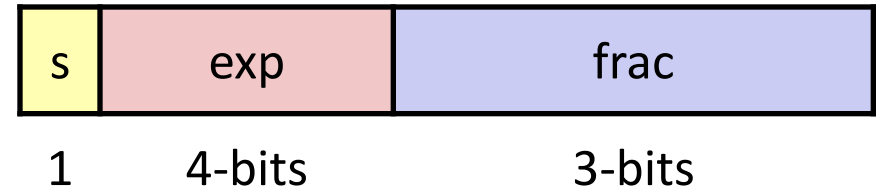

■ Case Study

- Convert 8-bit unsigned numbers to tiny floating point format

Example Numbers

128	10000000
15	00001101
33	00010001
35	00010011
138	10001010
63	00111111

Normalize

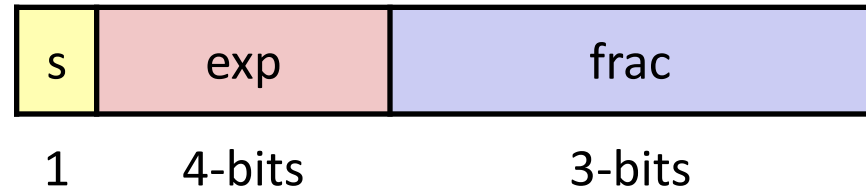

■ Requirement

- Set binary point so that numbers of form 1.xxxxx
- Adjust all to have leading one
 - Decrement exponent as shift left

<i>Value</i>	<i>Binary</i>	<i>Fraction</i>	<i>Exponent</i>
128	10000000	1.0000000	7
15	00001101	1.1010000	3
17	00010001	1.0001000	4
19	00010011	1.0011000	4
138	10001010	1.0001010	7
63	00111111	1.1111100	5

Postnormalize

■ Issue

- Rounding may have caused overflow
- Handle by shifting right once & incrementing exponent

<i>Value</i>	<i>Rounded</i>	<i>Exp</i>	<i>Adjusted</i>	<i>Numeric Result</i>
128	1.000	7		128
15	1.101	3		15
17	1.000	4		16
19	1.010	4		20
138	1.001	7		134
63	10.000	5	1.000/6	64

Tiny Floating Point Example

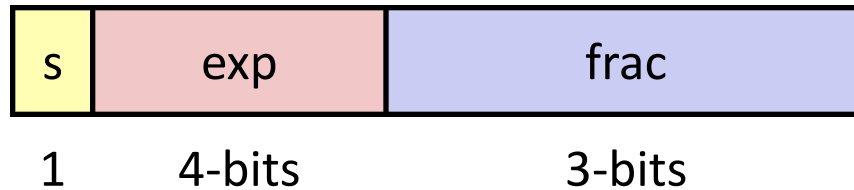

■ 8-bit Floating Point Representation

- the sign bit is in the most significant bit
- the next four bits are the **exp**, with a bias of 7
- the last three bits are the **frac**

■ Same general form as IEEE Format

- normalized, denormalized
- representation of 0, NaN, infinity