

## 15-213

"The course that gives CMU its Zip!"

## The Memory Hierarchy Feb. 20, 2003

### Topics

- Storage technologies and trends
- Locality of reference
- Caching in the memory hierarchy

c1ass12.ppt

## Random-Access Memory (RAM)

### Key features

- RAM is packaged as a chip.
- Basic storage unit is a cell (one bit per cell).
- Multiple RAM chips form a memory.

### Static RAM (SRAM)

- Each cell stores bit with a six-transistor circuit.
- Retains value indefinitely, as long as it is kept powered.
- Relatively insensitive to disturbances such as electrical noise.
- Faster and more expensive than DRAM.

### Dynamic RAM (DRAM)

- Each cell stores bit with a capacitor and transistor.
- Value must be refreshed every 10-100 ms.
- Sensitive to disturbances.
- Slower and cheaper than SRAM.

-2-

15-213, S'03

## SRAM vs DRAM Summary

	Tran. per bit	Access time	Persist?	Sensitive?	Cost	Applications
SRAM	6	1X	Yes	No	100X	cache memories
DRAM	1	10X	No	Yes	1X	Main memories, frame buffers

-3-

15-213, S'03

## Conventional DRAM Organization

### d x w DRAM:

- dw total bits organized as d supercells of size w bits

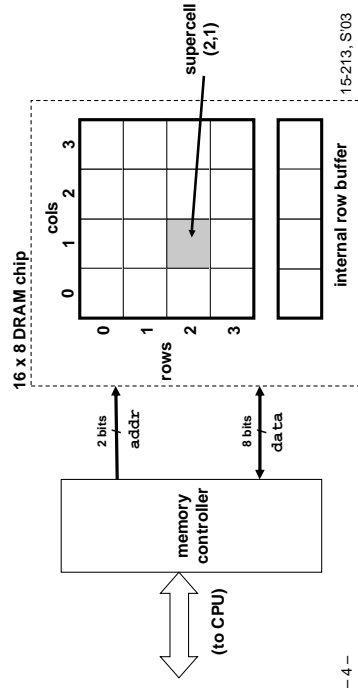

-4-

15-213, S'03

## Reading DRAM Supercell (2,1)

- Step 1(a): Row access strobe (RAS) selects row 2.  
 Step 1(b): Row 2 copied from DRAM array to row buffer.

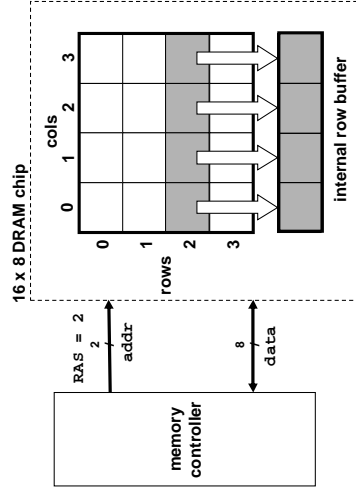

- 5 -

15-213, S'03

## Reading DRAM Supercell (2,1)

- Step 2(a): Column access strobe (CAS) selects column 1.  
 Step 2(b): Supercell (2,1) copied from buffer to data lines, and eventually back to the CPU.

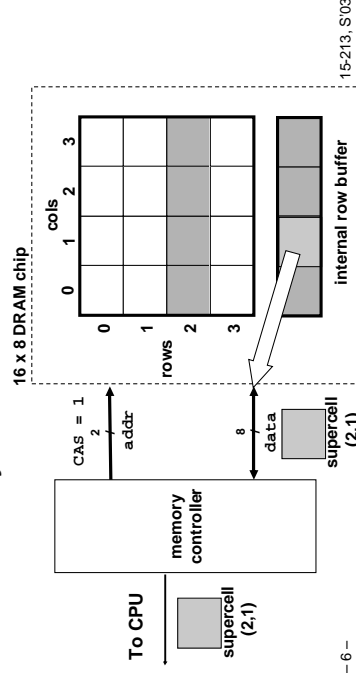

- 6 -

15-213, S'03

## Memory Modules

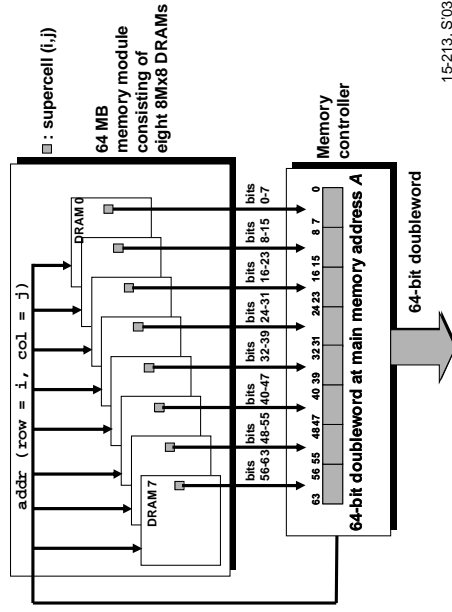

- 7 -

15-213, S'03

## Enhanced DRAMs

All enhanced DRAMs are built around the conventional DRAM core.

- Fast page mode DRAM (FPM DRAM)
  - Access contents of row with [RAS, CAS, CAS, CAS, CAS] instead of [(RAS,CAS), (RAS,CAS), (RAS,CAS), (RAS,CAS)].
- Extended data out DRAM (EDO DRAM)
  - Enhanced FPM DRAM with more closely spaced CAS signals.
- Synchronous DRAM (SDRAM)
  - Driven with rising clock edge instead of asynchronous control signals.
- Double data-rate synchronous DRAM (DDR SDRAM)
  - Enhancement of SDRAM that uses both clock edges as control signals.
- Video RAM (VRAM)
  - Like FPM DRAM, but output is produced by shifting row buffer
  - Dual ported (allows concurrent reads and writes)

- 8 -

15-213, S'03

## Nonvolatile Memories

DRAM and SRAM are volatile memories

- Lose information if powered off.
- Nonvolatile memories retain value even if powered off.
- Generic name is read-only memory (ROM).
- Misleading because some ROMs can be read and modified.

### Types of ROMs

- Programmable ROM (PROM)
- Erasable programmable ROM (EPROM)
- Electrically erasable PROM (EEPROM)
- Flash memory

### Firmware

- Program stored in a ROM
  - Boot time code, BIOS (basic input/output system)
  - graphics cards, disk controllers.

- 9 -

15-213, S'03

## Typical Bus Structure Connecting CPU and Memory

A bus is a collection of parallel wires that carry address, data, and control signals.  
Buses are typically shared by multiple devices.

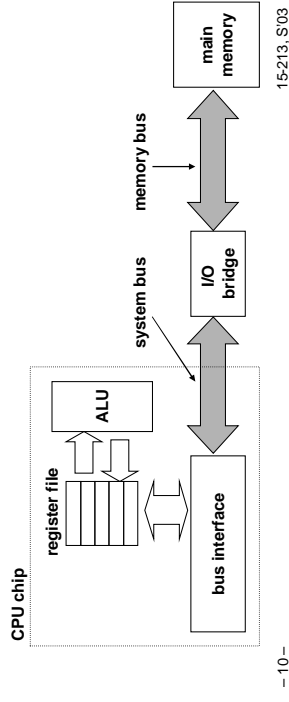

- 10 -

15-213, S'03

## Memory Read Transaction (1)

CPU places address A on the memory bus.

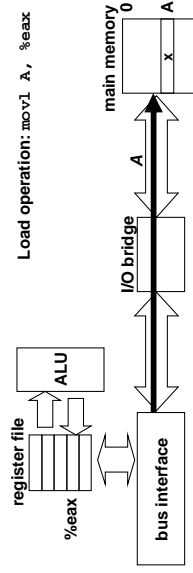

- 11 -

15-213, S'03

## Memory Read Transaction (2)

Main memory reads A from the memory bus, retrieves word x, and places it on the bus.

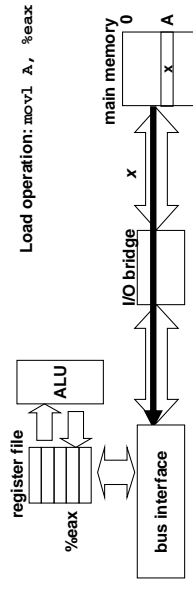

- 12 -

15-213, S'03

### Memory Read Transaction (3)

CPU read word *x* from the bus and copies it into register *%eax*.

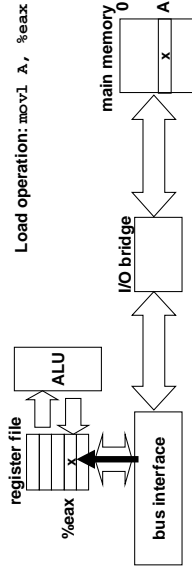

- 13 -

15-213, S'03

### Memory Write Transaction (1)

CPU places address *A* on bus. Main memory reads it and waits for the corresponding data word to arrive.

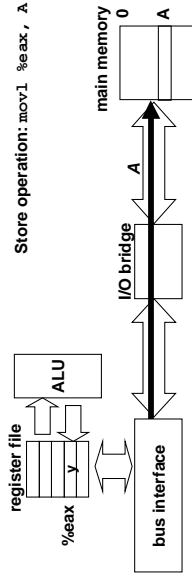

- 14 -

15-213, S'03

### Memory Write Transaction (2)

CPU places data word *y* on the bus.

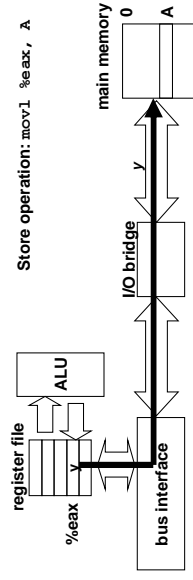

- 15 -

15-213, S'03

### Memory Write Transaction (3)

Main memory reads data word *y* from the bus and stores it at address *A*.

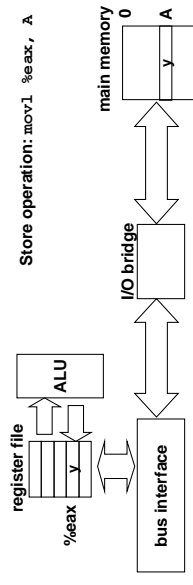

- 16 -

15-213, S'03

## Disk Geometry

Disks consist of platters, each with two surfaces.  
 Each surface consists of concentric rings called tracks.  
 Each track consists of sectors separated by gaps.

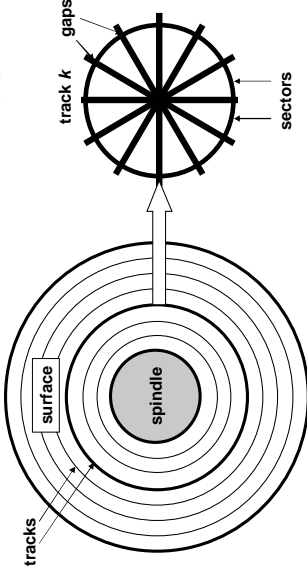

-17-

15-213, S'03

## Disk Geometry (Multiple-Platter View)

Aligned tracks form a cylinder.

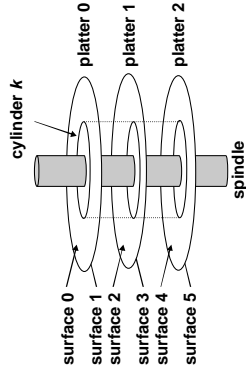

-18-

15-213, S'03

## Disk Capacity

Capacity: maximum number of bits that can be stored.

- Vendors express capacity in units of gigabytes (GB), where  $1 \text{ GB} = 10^9$ .

Capacity is determined by these technology factors:

- Recording density (bits/in): number of bits that can be squeezed into a 1 inch segment of a track.
- Track density (tracks/in): number of tracks that can be squeezed into a 1 inch radial segment.
- Areal density (bits/in<sup>2</sup>): product of recording and track density.

Modern disks partition tracks into disjoint subsets called recording zones

- Each track in a zone has the same number of sectors, determined by the circumference of innermost track.
- Each zone has a different number of sectors/track

-19-

15-213, S'03

## Computing Disk Capacity

$$\text{Capacity} = (\# \text{ bytes/sector}) \times (\text{avg. } \# \text{ sectors/track}) \times (\# \text{ tracks/surface}) \times (\# \text{ surfaces/platter}) \times (\# \text{ platters/disk})$$

Example:

- 512 bytes/sector
- 300 sectors/track (on average)
- 20,000 tracks/surface
- 2 surfaces/platter
- 5 platters/disk

$$\begin{aligned} \text{Capacity} &= 512 \times 300 \times 20000 \times 2 \times 5 \\ &= 30,720,000,000 \\ &= 30.72 \text{ GB} \end{aligned}$$

-20-

15-213, S'03

## Disk Operation (Single-Platter View)

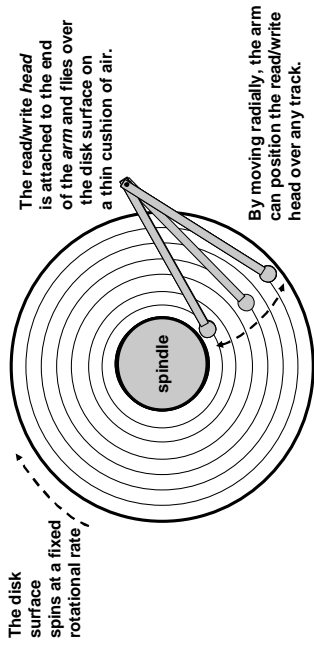

-21-

15-213, S'03

## Disk Operation (Multi-Platter View)

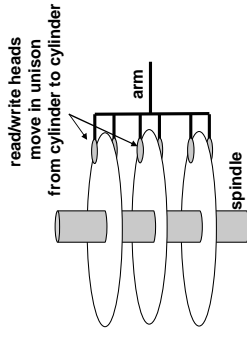

-22-

15-213, S'03

## Disk Access Time

Average time to access some target sector approximated by :

- $T_{\text{access}} = T_{\text{avg seek}} + T_{\text{avg rotation}} + T_{\text{avg transfer}}$

Seek time ( $T_{\text{avg seek}}$ )

- Time to position heads over cylinder containing target sector.
- Typical  $T_{\text{avg seek}} = 9 \text{ ms}$

Rotational latency ( $T_{\text{avg rotation}}$ )

- Time waiting for first bit of target sector to pass under r/w/w head.
- $T_{\text{avg rotation}} = 1/2 \times 1/\text{RPMs} \times 60 \text{ sec}/1 \text{ min}$

Transfer time ( $T_{\text{avg transfer}}$ )

- Time to read the bits in the target sector.
- $T_{\text{avg transfer}} = 1/\text{RPM} \times 1/(\text{avg \# sectors/track}) \times 60 \text{ secs}/1 \text{ min}$ .

-23-

15-213, S'03

## Disk Access Time Example

Given:

- Rotational rate = 7,200 RPM
- Average seek time = 9 ms.
- Avg # sectors/track = 400.

Derived:

- $T_{\text{avg rotation}} = 1/2 \times (60 \text{ secs}/7200 \text{ RPM}) \times 1000 \text{ ms/sec} = 4 \text{ ms}$ .
- $T_{\text{avg transfer}} = 60/7200 \text{ RPM} \times 1/400 \text{ secs/track} \times 1000 \text{ ms/sec} = 0.02 \text{ ms}$
- $T_{\text{access}} = 9 \text{ ms} + 4 \text{ ms} + 0.02 \text{ ms}$

Important points:

- Access time dominated by seek time and rotational latency.
- First bit in a sector is the most expensive, the rest are free.
- SRAM access time is about 4 ns/doubleword, DRAM about 60 ns
  - Disk is about 40,000 times slower than SRAM,
  - 2,500 times slower than DRAM.

-24-

15-213, S'03

## Logical Disk Blocks

Modern disks present a simpler abstract view of the complex sector geometry:

- The set of available sectors is modeled as a sequence of b-sized logical blocks (0, 1, 2, ...)

Mapping between logical blocks and actual (physical) sectors

- Maintained by hardware/firmware device called disk controller.
- Converts requests for logical blocks into (surface, track, sector) triples.

Allows controller to set aside spare cylinders for each zone.

- Accounts for the difference in “formatted capacity” and “maximum capacity”.

-25-

15-213, S'03

## I/O Bus

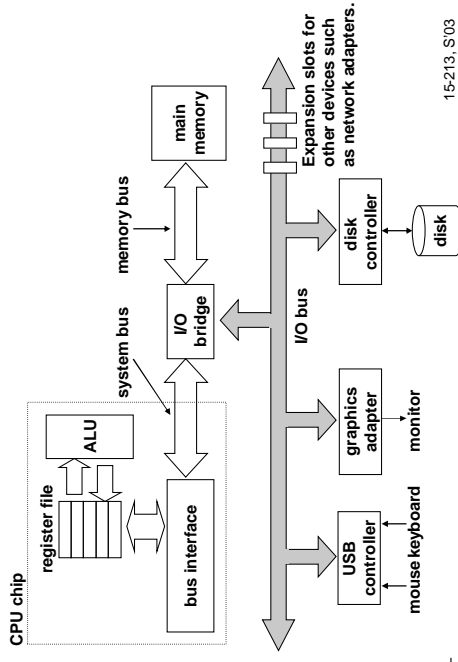

-26-

15-213, S'03

## Reading a Disk Sector (1)

CPU chip

CPU initiates a disk read by writing a command, logical block number, and destination memory address to a port (address) associated with disk controller.

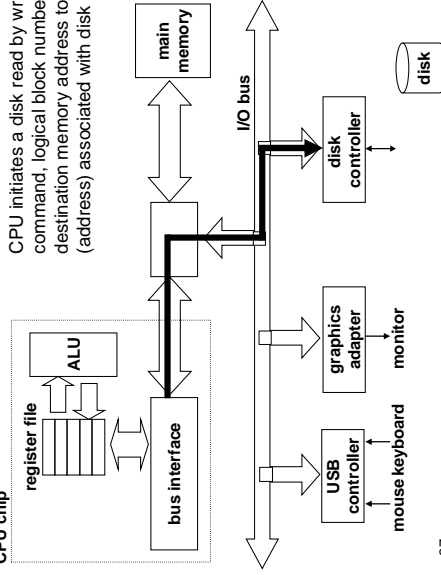

-27-

15-213, S'03

## Reading a Disk Sector (2)

CPU chip

Disk controller reads the sector and performs a direct memory access (DMA) transfer into main memory.

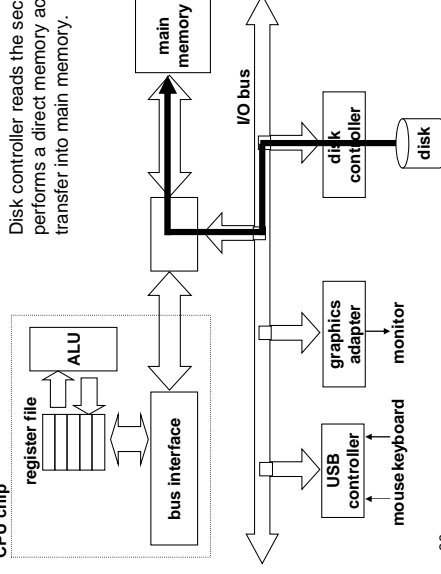

-28-

15-213, S'03

## Reading a Disk Sector (3)

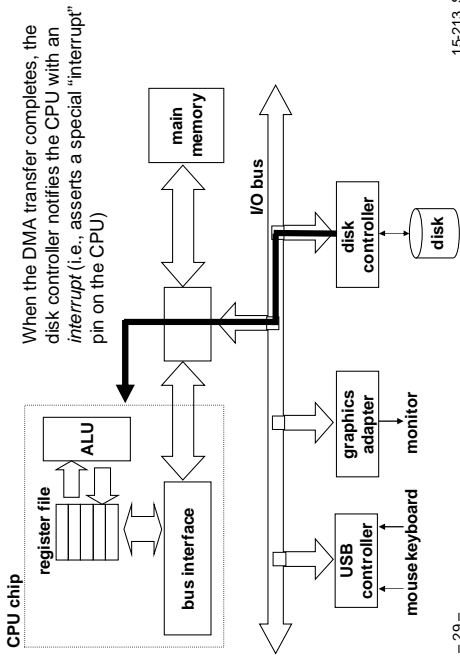

-29-

15-213, S'03

## Storage Trends

metric	1980	1985	1990	1995	2000	2000:1980
<b>SRAM</b>						
\$/MB	19,200	2,900	320	256	100	190
access (ns)	300	150	35	15	2	100
<b>DRAM</b>						
metric	1980	1985	1990	1995	2000	2000:1980
\$/MB	8,000	880	100	30	1	8,000
access (ns)	375	200	100	70	60	6
typical size(MB)	0.064	0.256	4	16	64	1,000
<b>Disk</b>						
metric	1980	1985	1990	1995	2000	2000:1980
\$/MB	500	100	8	0.30	0.05	10,000
access (ms)	87	75	28	10	8	11
typical size(MB)	1	10	160	1,000	9,000	9,000

-30-

(Culled from back issues of Byte and PC Magazine) 15-213, S'03

## CPU Clock Rates

	1980	1985	1990	1995	2000	2000:1980
<b>processor</b>	8080	286	386	Pent	P-III	
clock rate(MHz)	1	6	20	150	750	750
cycle time(ns)	1,000	166	50	6	1.6	750

-31-

15-213, S'03

## The CPU-Memory Gap

The increasing gap between DRAM, disk, and CPU speeds.

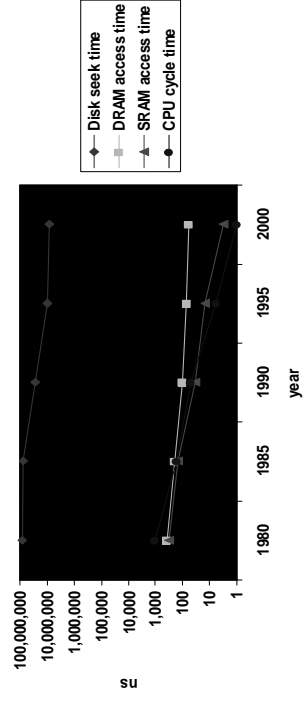

-32-

15-213, S'03



## Locality

### Principle of Locality:

- Programs tend to reuse data and instructions near those they have used recently, or that were recently referenced themselves.
- Temporal locality: Recently referenced items are likely to be referenced in the near future.
- Spatial locality: Items with nearby addresses tend to be referenced close together in time.

### Locality Example:

- Data
  - Reference array elements in succession (stride-1 reference pattern): **Spatial locality**
  - Reference `sum` each iteration: **Temporal locality**
- Instructions
  - Reference instructions in sequence: **Spatial locality**
  - Cycle through loop repeatedly: **Temporal locality**

```
sum = 0;
for (i = 0; i < n; i++)
    sum += a[i];
return sum;
```

-33-

15-213, S03

## Locality Example

**Claim:** Being able to look at code and get a qualitative sense of its locality is a key skill for a professional programmer.

**Question:** Does this function have good locality?

```
int summarizeRows(int a[M][N])
{
    int i, j, sum = 0;
    for (i = 0; i < M; i++)
        for (j = 0; j < N; j++)
            sum += a[i][j];
    return sum;
}
```

-34-

15-213, S03

## Locality Example

**Question:** Does this function have good locality?

```
int summarizeCols(int a[M][N])
{
    int i, j, sum = 0;
    for (j = 0; j < N; j++)
        for (i = 0; i < M; i++)
            sum += a[i][j];
    return sum;
}
```

-35-

15-213, S03

## Locality Example

**Question:** Can you permute the loops so that the function scans the 3-d array `a[]` with a stride-1 reference pattern (and thus has good spatial locality)?

```
int summarize3d(int a[M][N][N])
{
    int i, j, k, sum = 0;
    for (i = 0; i < M; i++)
        for (j = 0; j < N; j++)
            for (k = 0; k < N; k++)
                sum += a[k][i][j];
    return sum;
}
```

-36-

15-213, S03

## Memory Hierarchies

Some fundamental and enduring properties of hardware

- and software:
- Fast storage technologies cost more per byte and have less capacity.
  - The gap between CPU and main memory speed is widening.
  - Well-written programs tend to exhibit good locality.

These fundamental properties complement each other beautifully.

They suggest an approach for organizing memory and storage systems known as a memory hierarchy.

- 37 -

15-213, S'03

## An Example Memory Hierarchy

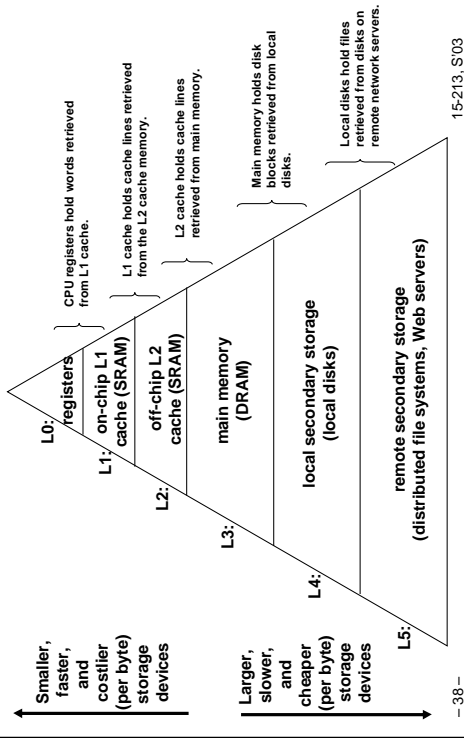

## Caches

Cache: A smaller, faster storage device that acts as a staging area for a subset of the data in a larger, slower device.

Fundamental idea of a memory hierarchy:

- For each  $k$ , the faster, smaller device at level  $k$  serves as a cache for the larger, slower device at level  $k+1$ .

Why do memory hierarchies work?

- Programs tend to access the data at level  $k$  more often than they access the data at level  $k+1$ .
- Thus, the storage at level  $k+1$  can be slower, and thus larger and cheaper per bit.
- Net effect: A large pool of memory that costs as much as the cheap storage near the bottom, but that serves data to programs at the rate of the fast storage near the top.

- 39 -

15-213, S'03

## Caching in a Memory Hierarchy

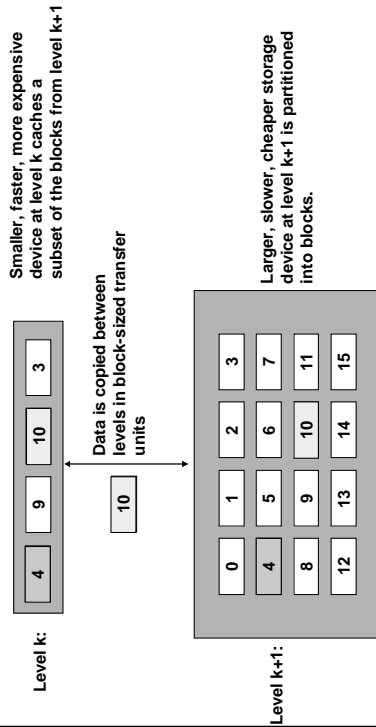

## General Caching Concepts

Program needs object d, which is stored in some block b.

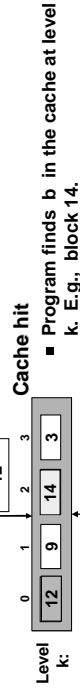

Cache hit

- Program finds b in the cache at level k. E.g., block 14.

Cache miss

- b is not at level k, so level k cache must fetch it from level k+1. E.g., block 12.

- If level k cache is full, then some current block must be replaced (evicted). Which one is the "victim"?
  - Placement policy: where can the new block go? E.g.,  $b \text{ mod } 4$
  - Replacement policy: which block should be evicted? E.g., LRU

-41-

15-213, S'03

## General Caching Concepts

Types of cache misses:

- Cold (compulsory) miss
    - Cold misses occur because the cache is empty.
  - Conflict miss
    - Most caches limit blocks at level k+1 to a small subset (sometimes a singleton) of the block positions at level k. E.g. Block i at level k+1 must be placed in block  $(i \text{ mod } 4)$  at level k+1.
  - Capacity miss
    - Conflict misses occur when the level k cache is large enough, but multiple data objects all map to the same level k block. E.g. Referencing blocks 0, 8, 0, 8, 0, 8, ... would miss every time.
- Occurs when the set of active cache blocks (working set) is larger than the cache.

-42-

15-213, S'03

## Examples of Caching in the Hierarchy

Cache Type	What Cached	Where Cached	Latency (cycles)	Managed By
Registers	4-byte word	CPU registers	0	Compiler
TLB	Address translations	On-Chip TLB	0	Hardware
L1 cache	32-byte block	On-Chip L1	1	Hardware
L2 cache	32-byte block	Off-Chip L2	10	Hardware
Virtual Memory	4-KB page	Main memory	100	Hardware+ OS
Buffer cache	Parts of files	Main memory	100	OS
Network buffer cache	Parts of files	Local disk	10,000,000	AFS/NFS client
Browser cache	Web pages	Local disk	10,000,000	Web browser
Web cache	Web pages	Remote server disks	1,000,000,000	Web proxy server

-43-

15-213, S'03