

Floating Point

15-213: Introduction to Computer Systems
4th Lecture, Sep. 10, 2015

Instructors:

Randal E. Bryant and David R. O'Hallaron

Today: Floating Point

- Background: Fractional binary numbers
- IEEE floating point standard: Definition
- Example and properties
- Rounding, addition, multiplication
- Floating point in C
- Summary

Fractional binary numbers

- What is 1011.101_2 ?

Fractional Binary Numbers

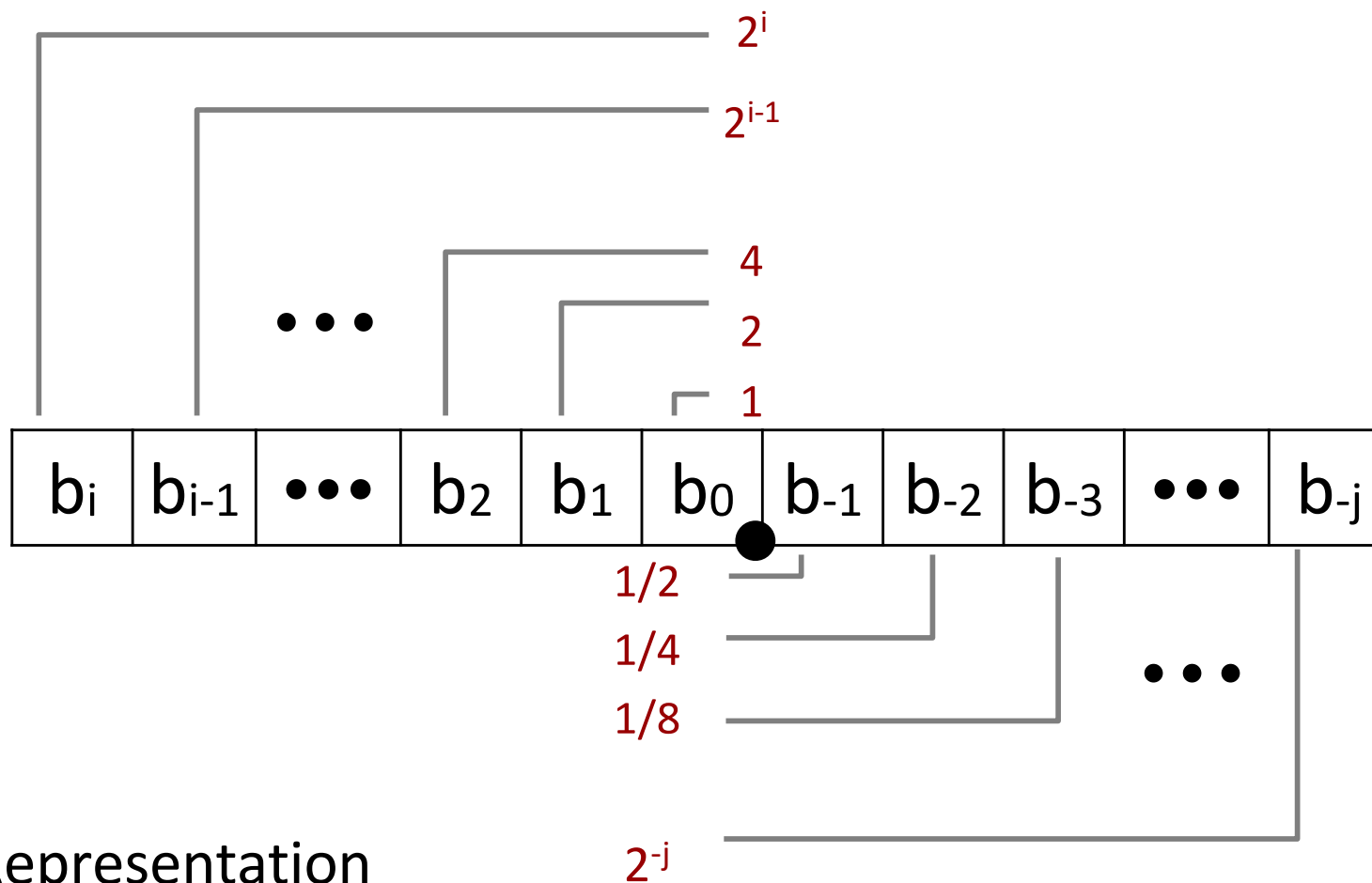

■ Representation

- Bits to right of “binary point” represent fractional powers of 2
- Represents rational number:

$$\sum_{k=-j}^i b_k \times 2^k$$

Fractional Binary Numbers: Examples

- | ■ Value | Representation |
|---------|---------------------|
| 5 3/4 | 101.11 ₂ |
| 2 7/8 | 10.111 ₂ |
| 1 7/16 | 1.0111 ₂ |
-
- Observations
 - Divide by 2 by shifting right (unsigned)
 - Multiply by 2 by shifting left
 - Numbers of form 0.111111...₂ are just below 1.0
 - $1/2 + 1/4 + 1/8 + \dots + 1/2^i + \dots \rightarrow 1.0$
 - Use notation $1.0 - \epsilon$

Representable Numbers

■ Limitation #1

- Can only exactly represent numbers of the form $x/2^k$
 - Other rational numbers have repeating bit representations

■ Value	Representation
■ $1/3$	$0.0101010101 [01] \dots_2$
■ $1/5$	$0.001100110011 [0011] \dots_2$
■ $1/10$	$0.0001100110011 [0011] \dots_2$

■ Limitation #2

- Just one setting of binary point within the w bits
 - Limited range of numbers (very small values? very large?)

Today: Floating Point

- Background: Fractional binary numbers
- IEEE floating point standard: Definition
- Example and properties
- Rounding, addition, multiplication
- Floating point in C
- Summary

IEEE Floating Point

- IEEE Standard 754
 - Established in 1985 as uniform standard for floating point arithmetic
 - Before that, many idiosyncratic formats
 - Supported by all major CPUs

- Driven by numerical concerns
 - Nice standards for rounding, overflow, underflow
 - Hard to make fast in hardware
 - Numerical analysts predominated over hardware designers in defining standard

Floating Point Representation

■ Numerical Form:

$$(-1)^s M 2^E$$

- Sign bit s determines whether number is negative or positive
- Significand M normally a fractional value in range $[1.0, 2.0)$.
- Exponent E weights value by power of two

■ Encoding

- MSB s is sign bit s
- exp field encodes E (but is not equal to E)
- frac field encodes M (but is not equal to M)



Precision options

- Single precision: 32 bits



- Double precision: 64 bits



- Extended precision: 80 bits (Intel only)



“Normalized” Values

$$v = (-1)^s M 2^E$$

- When: $\text{exp} \neq 000\dots 0$ and $\text{exp} \neq 111\dots 1$
- Exponent coded as a biased value: $E = \text{Exp} - \text{Bias}$
 - Exp: unsigned value of exp field
 - Bias = $2^{k-1} - 1$, where k is number of exponent bits
 - Single precision: 127 (Exp: 1...254, E: -126...127)
 - Double precision: 1023 (Exp: 1...2046, E: -1022...1023)
- Significand coded with implied leading 1: $M = 1.\text{xxx}\dots\text{x}_2$
 - xxx...x: bits of frac field
 - Minimum when frac=000...0 ($M = 1.0$)
 - Maximum when frac=111...1 ($M = 2.0 - \epsilon$)
 - Get extra leading bit for “free”

Normalized Encoding Example

$$v = (-1)^s M 2^E$$

$$E = \text{Exp} - \text{Bias}$$

■ Value: float $F = 15213.0$;

$$15213_{10} = 11101101101101_2$$

$$= 1.1101101101101_2 \times 2^{13}$$

■ Significand

$$M = 1.\underline{1101101101101}_2$$

$$\text{frac} = \underline{110110110110100000000000}_2$$

■ Exponent

$$E = 13$$

$$\text{Bias} = 127$$

$$\text{Exp} = 140 = 10001100_2$$

■ Result:

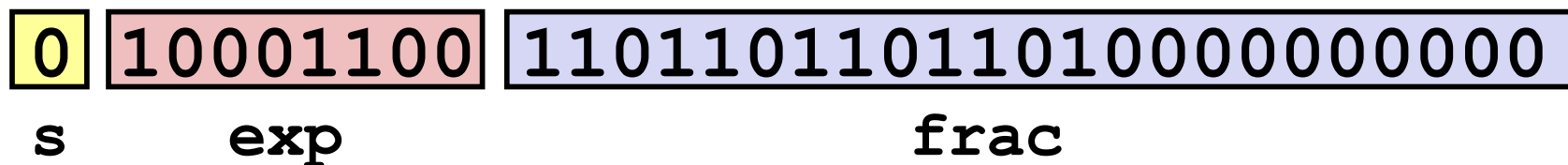

Denormalized Values

$$v = (-1)^s M 2^E$$

$$E = 1 - \text{Bias}$$

- Condition: $\text{exp} = 000\dots 0$
- Exponent value: $E = 1 - \text{Bias}$ (instead of $E = 0 - \text{Bias}$)
- Significand coded with implied leading 0: $M = 0.\text{xxx}\dots\text{x}_2$
 - **xxx...x**: bits of **frac**
- Cases
 - **exp** = 000...0, **frac** = 000...0
 - Represents zero value
 - Note distinct values: +0 and -0 (why?)
 - **exp** = 000...0, **frac** \neq 000...0
 - Numbers closest to 0.0
 - Equispaced

Special Values

- Condition: **exp** = 111...1

- Case: **exp** = 111...1, **frac** = 000...0
 - Represents value ∞ (infinity)
 - Operation that overflows
 - Both positive and negative
 - E.g., $1.0/0.0 = -1.0/-0.0 = +\infty$, $1.0/-0.0 = -\infty$

- Case: **exp** = 111...1, **frac** \neq 000...0
 - Not-a-Number (NaN)
 - Represents case when no numeric value can be determined
 - E.g., $\text{sqrt}(-1)$, $\infty - \infty$, $\infty \times 0$

Visualization: Floating Point Encodings

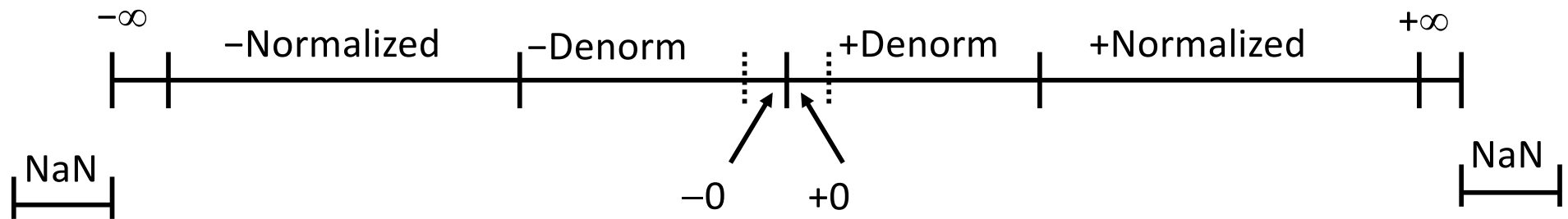

Today: Floating Point

- Background: Fractional binary numbers
- IEEE floating point standard: Definition
- Example and properties
- Rounding, addition, multiplication
- Floating point in C
- Summary

Tiny Floating Point Example

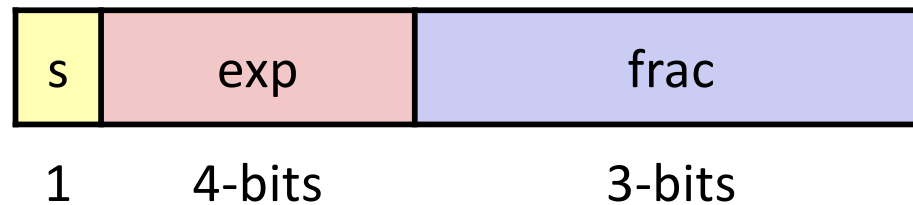

- 8-bit Floating Point Representation
 - the sign bit is in the most significant bit
 - the next four bits are the exponent, with a bias of 7
 - the last three bits are the **frac**

- Same general form as IEEE Format
 - normalized, denormalized
 - representation of 0, NaN, infinity

Dynamic Range (Positive Only)

	s	exp	frac	E	Value	
Denormalized numbers	0	0000	000	-6	0	
	0	0000	001	-6	$1/8 * 1/64 = 1/512$	
	0	0000	010	-6	$2/8 * 1/64 = 2/512$	
	...					
	0	0000	110	-6	$6/8 * 1/64 = 6/512$	
	0	0000	111	-6	$7/8 * 1/64 = 7/512$	
	Normalized numbers	0	0001	000	-6	$8/8 * 1/64 = 8/512$
0		0001	001	-6	$9/8 * 1/64 = 9/512$	
...						
0		0110	110	-1	$14/8 * 1/2 = 14/16$	
0		0110	111	-1	$15/8 * 1/2 = 15/16$	closest to 1 below
0		0111	000	0	$8/8 * 1 = 1$	
0		0111	001	0	$9/8 * 1 = 9/8$	closest to 1 above
0		0111	010	0	$10/8 * 1 = 10/8$	
...						
0		1110	110	7	$14/8 * 128 = 224$	
0	1110	111	7	$15/8 * 128 = 240$	largest norm	
0	1111	000	n/a	inf		

$$v = (-1)^s M 2^E$$

n: $E = \text{Exp} - \text{Bias}$

d: $E = 1 - \text{Bias}$

closest to zero

largest denorm

smallest norm

closest to 1 below

closest to 1 above

largest norm

Distribution of Values

■ 6-bit IEEE-like format

- $e = 3$ exponent bits
- $f = 2$ fraction bits
- Bias is $2^{3-1}-1 = 3$

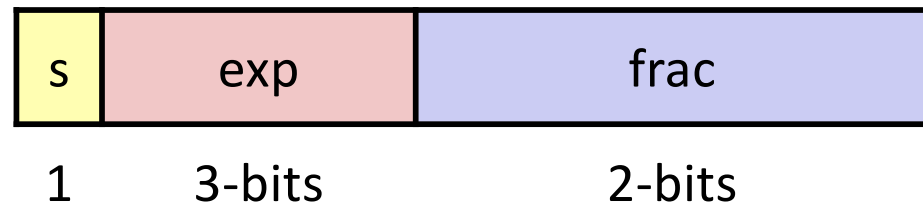

■ Notice how the distribution gets denser toward zero.

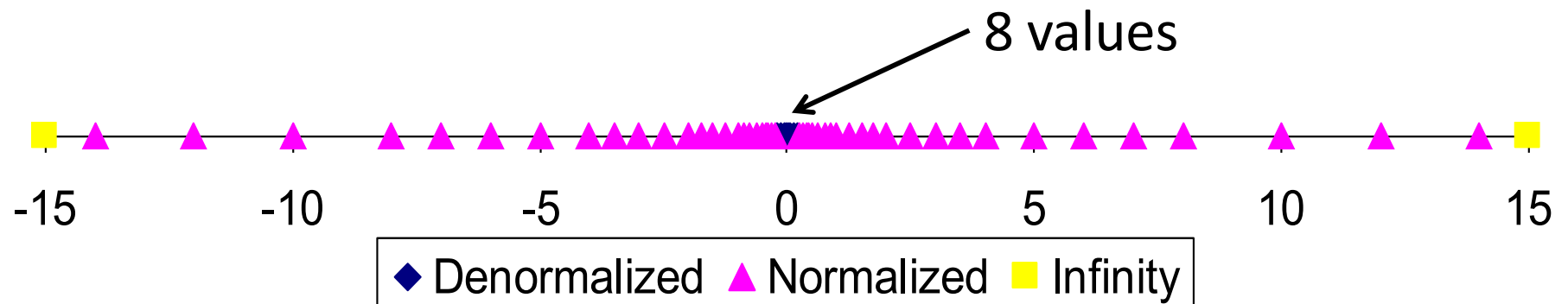

Distribution of Values (close-up view)

■ 6-bit IEEE-like format

- $e = 3$ exponent bits
- $f = 2$ fraction bits
- Bias is 3

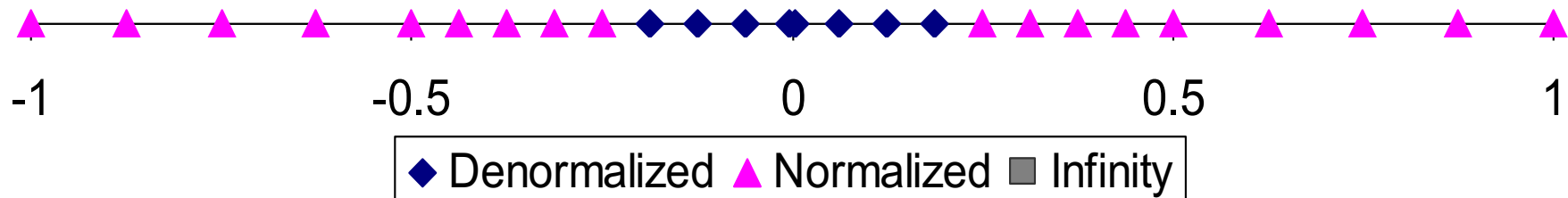
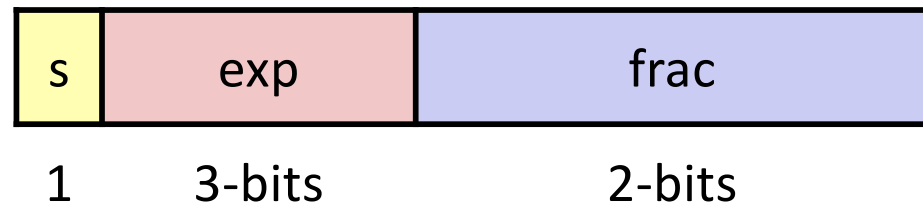

Special Properties of the IEEE Encoding

- FP Zero Same as Integer Zero
 - All bits = 0

- Can (Almost) Use Unsigned Integer Comparison
 - Must first compare sign bits
 - Must consider $-0 = 0$
 - NaNs problematic
 - Will be greater than any other values
 - What should comparison yield?
 - Otherwise OK
 - Denorm vs. normalized
 - Normalized vs. infinity

Today: Floating Point

- Background: Fractional binary numbers
- IEEE floating point standard: Definition
- Example and properties
- **Rounding, addition, multiplication**
- Floating point in C
- Summary

Floating Point Operations: Basic Idea

- $\mathbf{x} +_{\mathbf{f}} \mathbf{y} = \text{Round}(\mathbf{x} + \mathbf{y})$

- $\mathbf{x} \times_{\mathbf{f}} \mathbf{y} = \text{Round}(\mathbf{x} \times \mathbf{y})$

- Basic idea
 - First **compute exact result**
 - Make it fit into desired precision
 - Possibly overflow if exponent too large
 - Possibly **round to fit into frac**

Rounding

■ Rounding Modes (illustrate with \$ rounding)

■	\$1.40	\$1.60	\$1.50	\$2.50	-\$1.50
■ Towards zero	\$1	\$1	\$1	\$2	-\$1
■ Round down ($-\infty$)	\$1	\$1	\$1	\$2	-\$2
■ Round up ($+\infty$)	\$2	\$2	\$2	\$3	-\$1
■ Nearest Even (default)	\$1	\$2	\$2	\$2	-\$2

Closer Look at Round-To-Even

■ Default Rounding Mode

- Hard to get any other kind without dropping into assembly
- All others are statistically biased
 - Sum of set of positive numbers will consistently be over- or underestimated

■ Applying to Other Decimal Places / Bit Positions

- When exactly halfway between two possible values
 - Round so that least significant digit is even
- E.g., round to nearest hundredth

7.8949999	7.89	(Less than half way)
7.8950001	7.90	(Greater than half way)
7.8950000	7.90	(Half way—round up)
7.8850000	7.88	(Half way—round down)

Rounding Binary Numbers

■ Binary Fractional Numbers

- “Even” when least significant bit is 0
- “Half way” when bits to right of rounding position = 100...₂

■ Examples

- Round to nearest 1/4 (2 bits right of binary point)

Value	Binary	Rounded	Action	Rounded Value
2 3/32	10.00 011 ₂	10.00 ₂	(<1/2—down)	2
2 3/16	10.00 110 ₂	10.01 ₂	(>1/2—up)	2 1/4
2 7/8	10.11 100 ₂	11.00 ₂	(1/2—up)	3
2 5/8	10.10 100 ₂	10.10 ₂	(1/2—down)	2 1/2

FP Multiplication

- $(-1)^{s1} M1 2^{E1} \times (-1)^{s2} M2 2^{E2}$
- Exact Result: $(-1)^s M 2^E$
 - Sign s : $s1 \wedge s2$
 - Significand M : $M1 \times M2$
 - Exponent E : $E1 + E2$
- Fixing
 - If $M \geq 2$, shift M right, increment E
 - If E out of range, overflow
 - Round M to fit **frac** precision
- Implementation
 - Biggest chore is multiplying significands

Floating Point Addition

$$\blacksquare (-1)^{s1} M1 2^{E1} + (-1)^{s2} M2 2^{E2}$$

- Assume $E1 > E2$

$$\blacksquare \text{Exact Result: } (-1)^s M 2^E$$

- Sign s , significand M :
 - Result of signed align & add
- Exponent E : $E1$

Fixing

- If $M \geq 2$, shift M right, increment E
- if $M < 1$, shift M left k positions, decrement E by k
- Overflow if E out of range
- Round M to fit **frac** precision

Get binary points lined up

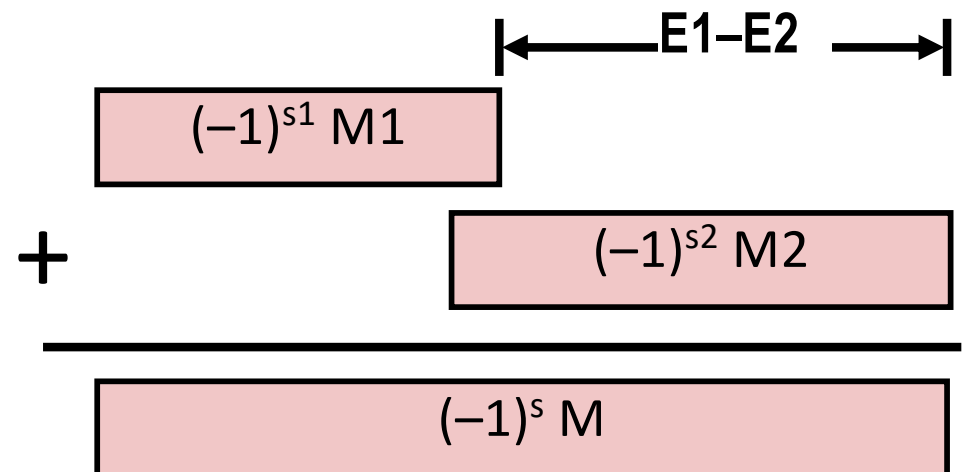

Mathematical Properties of FP Add

■ Compare to those of Abelian Group

- Closed under addition? Yes
 - But may generate infinity or NaN
- Commutative? Yes
- Associative? No
 - Overflow and inexactness of rounding
 - $(3.14+1e10)-1e10 = 0$, $3.14+(1e10-1e10) = 3.14$
- 0 is additive identity?
- Every element has additive inverse? Yes
 - Yes, except for infinities & NaNs Almost

■ Monotonicity

- $a \geq b \Rightarrow a+c \geq b+c$ Almost
 - Except for infinities & NaNs

Mathematical Properties of FP Mult

■ Compare to Commutative Ring

- Closed under multiplication? Yes
 - But may generate infinity or NaN
- Multiplication Commutative? Yes
- Multiplication is Associative? No
 - Possibility of overflow, inexactness of rounding
 - Ex: $(1e20 * 1e20) * 1e-20 = \text{inf}$, $1e20 * (1e20 * 1e-20) = 1e20$
- 1 is multiplicative identity? Yes
- Multiplication distributes over addition? No
 - Possibility of overflow, inexactness of rounding
 - $1e20 * (1e20 - 1e20) = 0.0$, $1e20 * 1e20 - 1e20 * 1e20 = \text{NaN}$

■ Monotonicity

- $a \geq b \ \& \ c \geq 0 \Rightarrow a * c \geq b * c$ Almost
 - Except for infinities & NaNs

Today: Floating Point

- Background: Fractional binary numbers
- IEEE floating point standard: Definition
- Example and properties
- Rounding, addition, multiplication
- Floating point in C
- Summary

Floating Point in C

■ C Guarantees Two Levels

- **float** single precision
- **double** double precision

■ Conversions/Casting

- Casting between **int**, **float**, and **double** changes bit representation
- **double/float** → **int**
 - Truncates fractional part
 - Like rounding toward zero
 - Not defined when out of range or NaN: Generally sets to TMin
- **int** → **double**
 - Exact conversion, as long as **int** has ≤ 53 bit word size
- **int** → **float**
 - Will round according to rounding mode

Floating Point Puzzles

■ For each of the following C expressions, either:

- Argue that it is true for all argument values
- Explain why not true

```
int x = ...;
float f = ...;
double d = ...;
```

Assume neither
d nor **f** is NaN

- `x == (int)(float) x`
- `x == (int)(double) x`
- `f == (float)(double) f`
- `d == (double)(float) d`
- `f == -(-f);`
- `2/3 == 2/3.0`
- `d < 0.0` \Rightarrow `((d*2) < 0.0)`
- `d > f` \Rightarrow `-f > -d`
- `d * d >= 0.0`
- `(d+f) - d == f`

Summary

- IEEE Floating Point has clear mathematical properties
- Represents numbers of form $M \times 2^E$
- One can reason about operations independent of implementation
 - As if computed with perfect precision and then rounded
- Not the same as real arithmetic
 - Violates associativity/distributivity
 - Makes life difficult for compilers & serious numerical applications programmers

Additional Slides

Creating Floating Point Number

■ Steps

- Normalize to have leading 1
- Round to fit within fraction
- Postnormalize to deal with effects of rounding

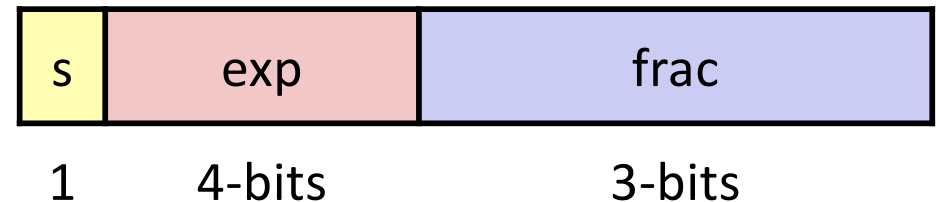

■ Case Study

- Convert 8-bit unsigned numbers to tiny floating point format

Example Numbers

128	10000000
13	00001101
17	00010001
19	00010011
138	10001010
63	00111111

Normalize

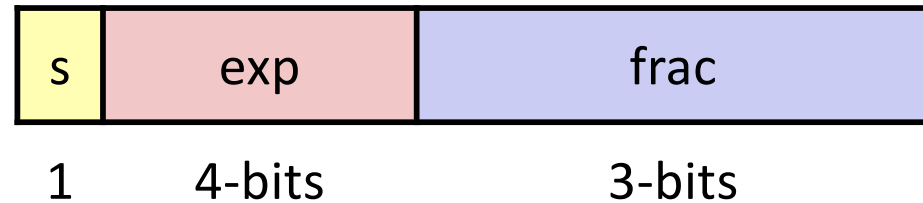

■ Requirement

- Set binary point so that numbers of form 1.xxxxx
- Adjust all to have leading one
 - Decrement exponent as shift left

Value	Binary	Fraction	Exponent
128	10000000	1.0000000	7
13	00001101	1.1010000	3
17	00010001	1.0001000	4
19	00010011	1.0011000	4
138	10001010	1.0001010	7
63	00111111	1.1111100	5

Rounding

1 . BBG**RXXX**

Guard bit: LSB of result

Sticky bit: OR of remaining bits

Round bit: 1st bit removed

■ Round up conditions

- Round = 1, Sticky = 1 → > 0.5
- Guard = 1, Round = 1, Sticky = 0 → Round to even

Value	Fraction	GRS	Incr?	Rounded
128	1.000 0000	000	N	1.000
13	1.101 0000	100	N	1.101
17	1.000 1000	010	N	1.000
19	1.001 1000	110	Y	1.010
138	1.000 1010	011	Y	1.001
63	1.111 1100	111	Y	10.000

Postnormalize

■ Issue

- Rounding may have caused overflow
- Handle by shifting right once & incrementing exponent

Value	Rounded	Exp	Adjusted	Result
128	1.000	7		128
13	1.101	3		13
17	1.000	4		16
19	1.010	4		20
138	1.001	7		144
63	10.000	5	1.000/6	64

Interesting Numbers

{single, double}

<i>Description</i>	<i>exp</i>	<i>frac</i>	<i>Numeric Value</i>
■ Zero	00...00	00...00	0.0
■ Smallest Pos. Denorm.	00...00	00...01	$2^{-\{23,52\}} \times 2^{-\{126,1022\}}$
■ Single $\approx 1.4 \times 10^{-45}$			
■ Double $\approx 4.9 \times 10^{-324}$			
■ Largest Denormalized	00...00	11...11	$(1.0 - \epsilon) \times 2^{-\{126,1022\}}$
■ Single $\approx 1.18 \times 10^{-38}$			
■ Double $\approx 2.2 \times 10^{-308}$			
■ Smallest Pos. Normalized	00...01	00...00	$1.0 \times 2^{-\{126,1022\}}$
■ Just larger than largest denormalized			
■ One	01...11	00...00	1.0
■ Largest Normalized	11...10	11...11	$(2.0 - \epsilon) \times 2^{\{127,1023\}}$
■ Single $\approx 3.4 \times 10^{38}$			
■ Double $\approx 1.8 \times 10^{308}$			