

15-884/484 – Electric Power Systems 2: Generators, Three-phase Power, and Power Electronics

J. Zico Kolter

October 10, 2013

Generators

- Basic AC Generator

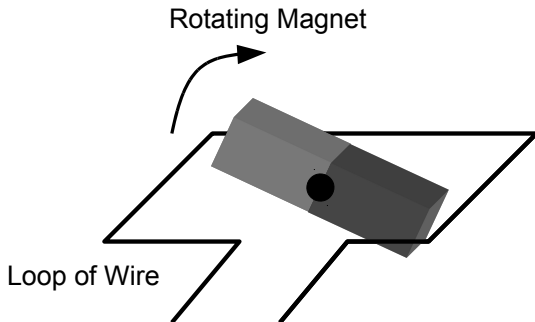

- Generator operation

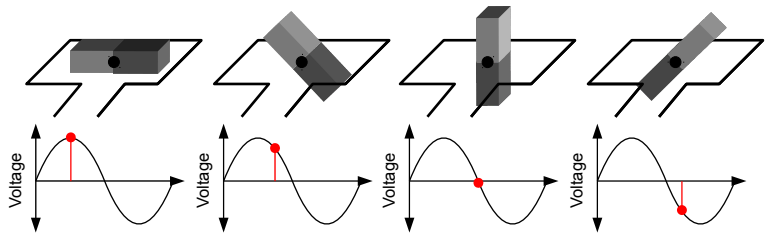

- **Rotor** - rotating element
- **Stator** - stationary element on the outside
- **Armature** - wires carrying the current (could be either in rotor or stator, but typically stator)
- **Synchronous generator** - generator moves “in sync” with power in grid
 - I.e., for U.S. AC power, generator spins at $60\text{Hz} = 3600\text{ RPM}$ (in practice, can have multiple poles in rotor magnet, allows for slower rotation)

- In practice, typically use electromagnet instead of permanent magnet in the rotor



- Needs a DC current source to create magnet (*exciter*), can come from separate generator or from grid
 - By increasing/decreasing exciter current, we change strength of magnet, which varies generator voltage
- Also, increase number of windings in armature, increases voltage (by fixed ratio)

- Typically can directly control two elements of the generator: (real) power and voltage
- Controlling real power:
 - Mechanical power and real power must be equal (ignoring losses)

$$P = \text{Re}\{\bar{I}V\} = \text{torque} \cdot \omega \text{ (torque times rotational velocity)}$$

- For synchronous generator, can't change rotational velocity; power change must come from change in torque
- Tightly controlled system that applies additional force from “prime mover” (i.e., gas or steam) to maintain rotational velocity

- What causes “force” on rotor?

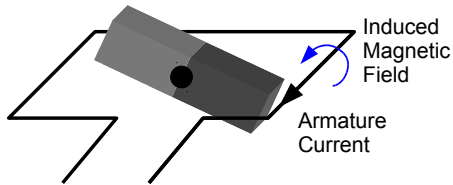

Armature current itself creates magnetic field opposing rotor revolution, requires force to overcome

- Indirectly control reactive power via voltage

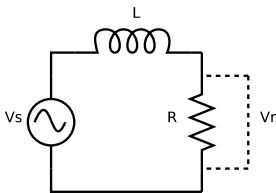

$$V_r = V_s \frac{R}{R + j\omega L}$$

- Voltage across resistor is *decreased* by adding inductor
- To maintain real power, we need to *increase* voltage
- Effectively, generator “supplies” reactive power by increasing voltage

Three phase power

- Most generators use three separate windings in armature, create three different phases of power

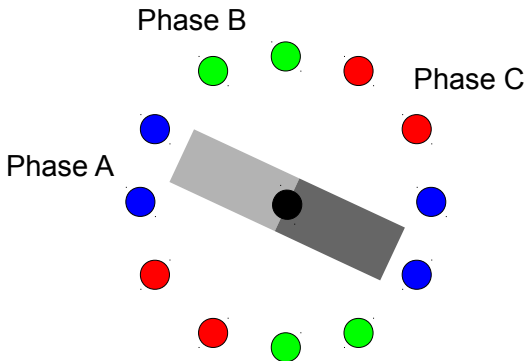

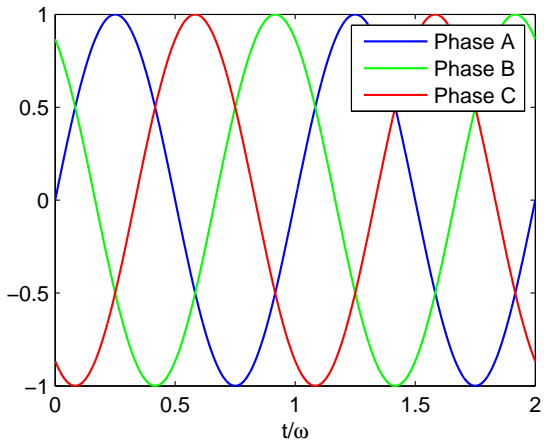

- Why three phase power?
- Hypothetical setup

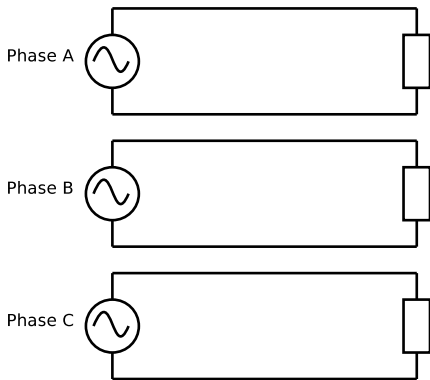

Need six wires

- However, nice property of three phase power is that currents cancel out (assuming all currents in phase with voltages, and that current magnitudes are equal)

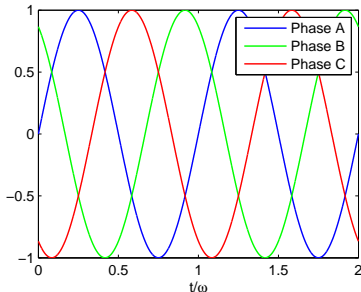

$$i_A(t) + i_B(t) + i_C(t) = 0, \quad \forall t$$

- True for any number of phases ≥ 2 ?

- Can derive this from trigonometric identities, but easy to see using complex representation

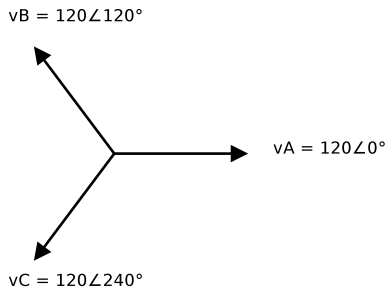

- Because of this, we can bring line together and form a single “neutral” return line

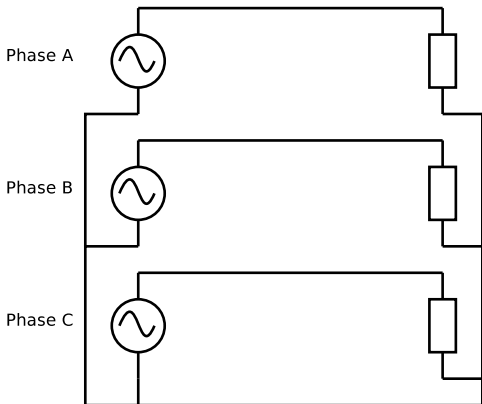

Need four wires

- Because return wire has practically zero voltage, we can even eliminate it altogether

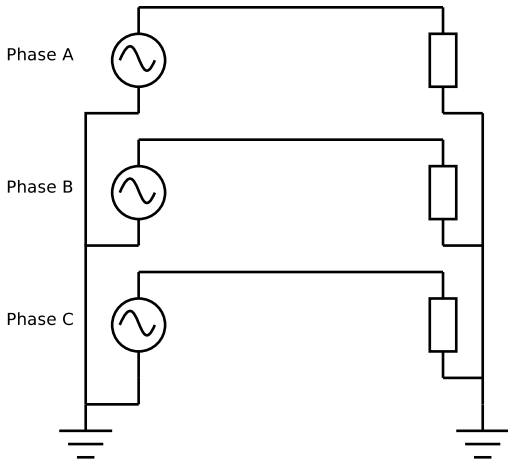

Need three wires

- Attaching three wires in this manner known as a “wye” connection

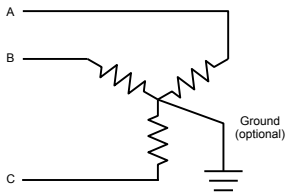

- Another common possibility is the “delta” connection, also a way of attaching loads with only three lines

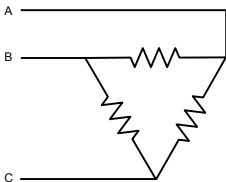

- Delta connection is directly connecting two different phases together, not obvious that this produces correct current in loads

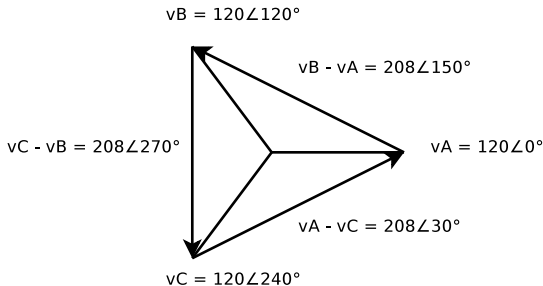

- Delta connector scales observed voltages by $\sqrt{3}$

- Another rationale for three phase power: equal power throughout rotation

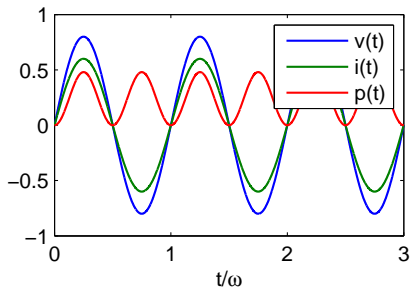

- Power for three phases

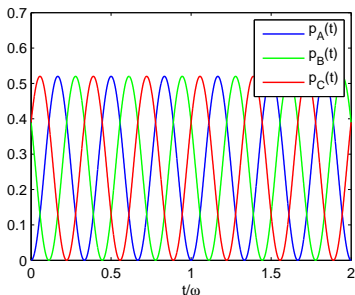

- Three sine waves 120 degrees out of phase, add to a constant number
 - Mechanically, this means the generator rotor experiences constant force throughout its revolution
- True for any number of phases ≥ 3 ?

Power Electronics

- Equipment that converts AC-DC voltage/current or AC-AC, DC-DC (but changes voltage)

AC - AC	Transformer (not called power electronics)
AC - DC	Rectifier
DC - AC	Inverter
DC - DC	Buck/Boost Converters

Transformers

- Simple transformer is two coils of wire around a magnet

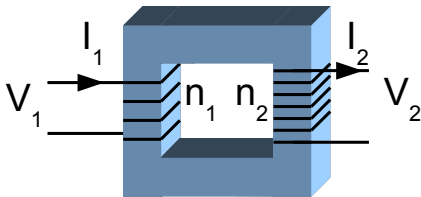

- Voltage scaling is proportional to the number of turns of wire

$$\frac{V_1}{V_2} = \frac{n_1}{n_2}$$

and since $V_1 I_1 = V_2 I_2$ for lossless transformer

$$\frac{V_1}{V_2} = \frac{n_1}{n_2} = \frac{I_2}{I_1}$$

- Symbol in circuit diagrams

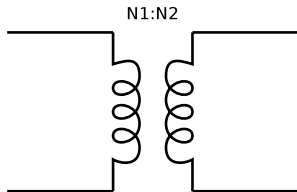

- Actual transformers will have some resistive losses, some amount of inductance
- Can also create three-phase transformers (delta and wye variants on each side) that only need the three lines

Rectifiers

- Basic element of the rectifier (and first non-linear circuit element we encounter is *diode*)



- Diode allows current to flow only in one direction
- Half-wave rectifier

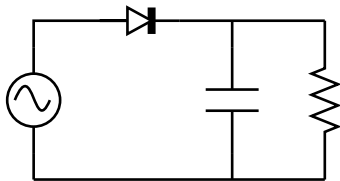

- Full-wave rectifier

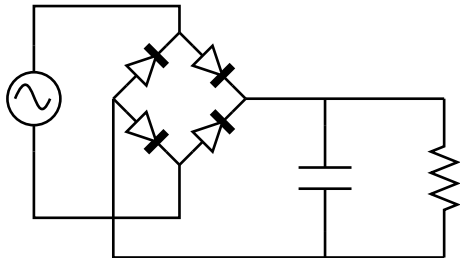

Inverters

- Inverters make use of *switches*, circuit elements that can be open or closed



- Switches are typically implemented via solid state electronics (transistors), digitally controlled
- H-bridge inverter

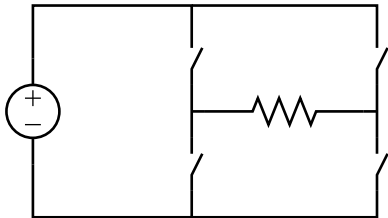

- Alternating between opening and closing diagonal switches

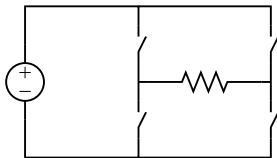

- Results in square wave voltage

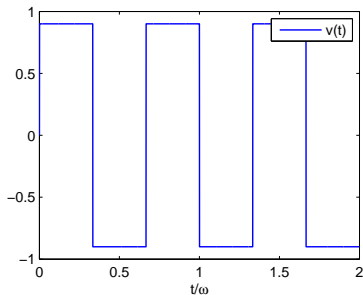

Can smooth through capacitors/inductors and also by switching more rapidly

DC-DC Converters

- DC-DC converters also make use of switches, typically at high frequencies (e.g. 10kHz or above)
- Buck converter: DC to lower voltage DC

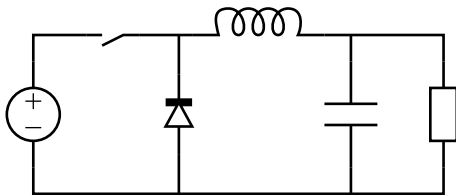

- Boost converter: DC to higher voltage DC

