

Koller & Friedman: Chapter 16
Boyen & Koller '98, '99
Uri Lerner's Thesis: Chapters 3,9
Paskin '03

Dynamic models 2

Switching KFs continued,
Assumed density filters,
DBNs, BK, extensions

Probabilistic Graphical Models – 10708

Carlos Guestrin

Carnegie Mellon University

November 21st, 2005

Announcement



- Special recitation lectures

- Pradeep will give two special lectures
- Nov. 22 & Dec. 1: 5-6pm, during recitation
- Covering: variational methods, loopy BP and their relationship
- Don't miss them!!!

- It's FCE time!!!

- Fill the forms online by Dec. 11
- www.cmu.edu/fce
- It will only take a few minutes
- Please, please, please help us improve the course by providing feedback

Last week in “Your BN Hero”

- Gaussian distributions reviewed
 - Linearity of Gaussians
 - Conditional Linear Gaussian (CLG)
- Kalman filter
 - HMMs with CLG distributions
 - Linearization of non-linear transitions and observations using numerical integration
- Switching Kalman filter
 - Discrete variable selects transition model depends
 - Mixture of Gaussians represents belief state
 - Number of mixture components grows exponentially in time

The moonwalk



Last week in “Your BN Hero”

- Gaussian distributions reviewed
 - Linearity of Gaussians
 - Conditional Linear Gaussian (CLG)
- Kalman filter
 - HMMs with CLG distributions
 - Linearization of non-linear transitions and observations using numerical integration
- Switching Kalman filter
 - Discrete variable selects transition model depends
 - Mixture of Gaussians represents belief state
 - Number of mixture components grows exponentially in time

Switching Kalman filter

- At each time step, choose one of k motion models:

- You never know which one!

- $p(X_{i+1}|X_i, Z_{i+1})$

- CLG indexed by Z_i

- $p(X_{i+1}|X_i, Z_{i+1}=j) \sim N(\beta_0^j + B^j X_i; \Sigma_{X_{i+1}|X_i}^j)$

depending on motion model

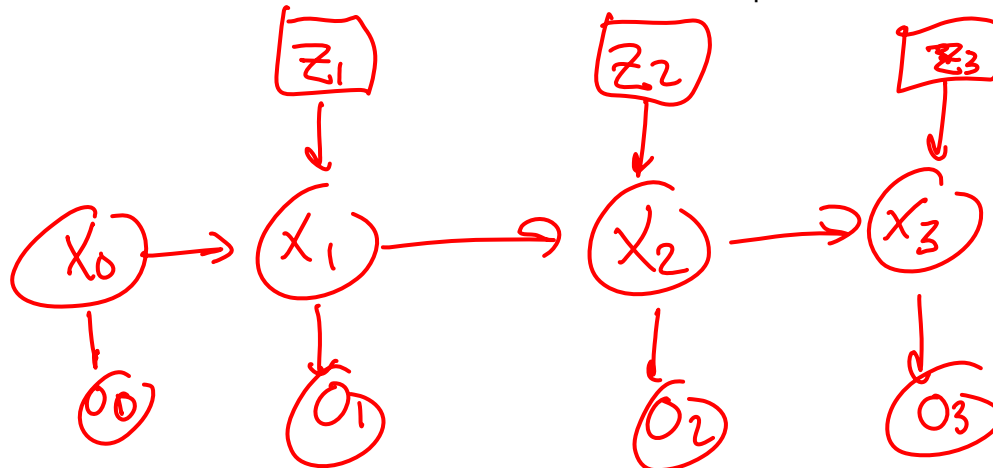

Inference in switching KF – one step

- Suppose
 - $p(X_0)$ is Gaussian
 - Z_1 takes one of two values
 - $p(X_1|X_0, Z_1)$ is CLG

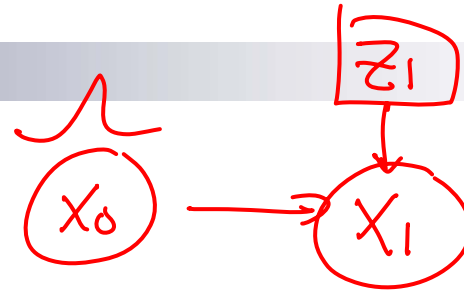

- Marginalize X_0 $p(x_1|z_1) = \int_{x_0} p(x_0) \cdot p(x_1|x_0, z_1) dx_0$

$z_1 \rightarrow$ straight
 $z_1 \rightarrow$ moonwalk

- Marginalize Z_1

$$p(x_1) = \sum_j p(x_1|z_1=j) \cdot P(z_1=j)$$

- Obtain mixture of two Gaussians!



Multi-step inference

$$x_i \rightarrow x_{i+1} \quad \begin{matrix} z_{i+1} \\ \downarrow \end{matrix}$$

- Suppose
 - $p(x_i)$ is a mixture of m Gaussians
 - Z_{i+1} takes one of two values
 - $p(x_{i+1}|x_i, Z_{i+1})$ is CLG



$$p(x_i) = \sum_{k=1}^m w_k N(\mu_k, \Sigma_k)$$

- Marginalize x_i

$$p(x_{i+1} | z_{i+1} = j) = \int_{x_i} p(x_{i+1} | x_i, z_i = j) \cdot p(x_i) dx_i$$

- Marginalize Z_i

$$= \sum_{k=1}^m w_k \int_{x_i} p(x_{i+1} | x_i, z_i = j) N(\mu_k, \Sigma_k) dx_i$$

$$\hookrightarrow p(x_{i+1}) = \sum_j p(z_{i+1} = j) \cdot p(x_{i+1} | z_{i+1} = j)$$

- Obtain mixture of $2m$ Gaussians!

- Number of Gaussians grows exponentially!!! *bumps*

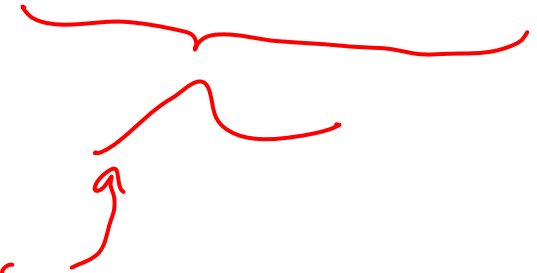
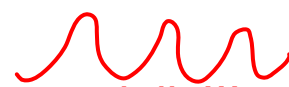

Visualizing growth in number of Gaussians

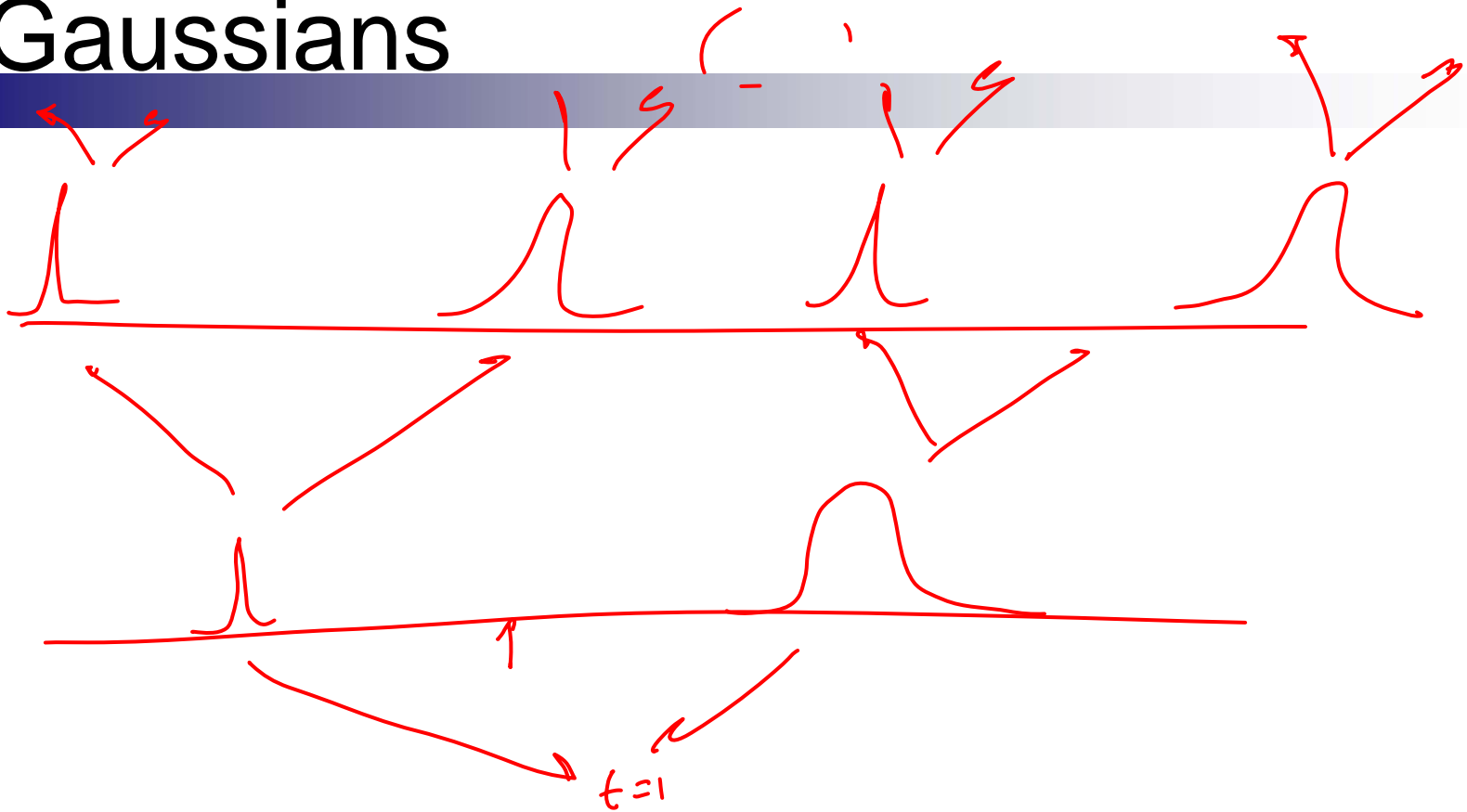

Computational complexity of inference in switching Kalman filters

- Switching Kalman Filter with (only) 2 motion models
- Query:
- **Problem is NP-hard!!!** [Lerner & Parr `01]
 - Why “!!!”?
 - Graphical model is a tree:
 - Inference efficient if all are discrete
 - Inference efficient if all are Gaussian
 - But not with hybrid model (combination of discrete and continuous)

Bounding number of Gaussians

- $P(X_i)$ has 2^m Gaussians, but...
 - usually, most are bumps have low probability and overlap:
-
- **Intuitive approximate inference:**
 - Generate $k \cdot m$ Gaussians
 - Approximate with m Gaussians

Collapsing Gaussians – Single Gaussian from a mixture

- Given mixture $P \langle w_i; N(\mu_i, \Sigma_i) \rangle$
- Obtain approximation $Q \sim N(\mu, \Sigma)$ as:

$$\mu = \sum_i w_i \mu_i$$

$$\Sigma = \sum_i w_i \Sigma_i + \sum_i w_i (\mu_i - \mu)(\mu_i - \mu)^T$$

- **Theorem:**
 - P and Q have same first and second moments
 - **KL projection:** Q is single Gaussian with lowest KL divergence from P

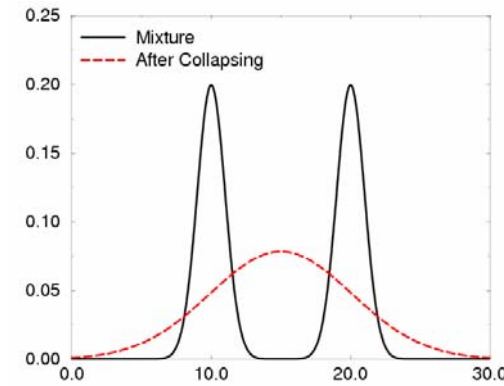

Collapsing mixture of Gaussians into smaller mixture of Gaussians

- Hard problem!
 - Akin to clustering problem...

- Several heuristics exist
 - *c.f.*, Uri Lerner's Ph.D. thesis

Operations in non-linear switching Kalman filter

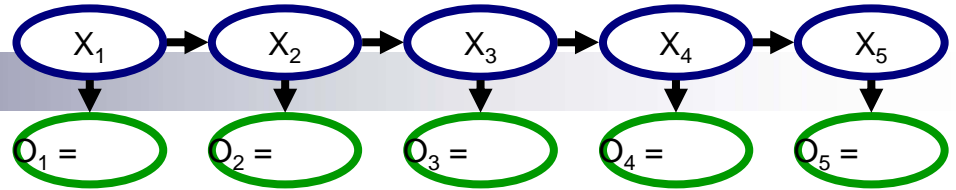

- Compute mixture of Gaussians for $p(X_t | O_{1:t} = o_{1:t})$
- Start with $p(X_0)$
- At each time step t :
 - For each of the m Gaussians in $p(X_i | o_{1:i})$:
 - **Condition** on observation (use **numerical integration**)
 - **Prediction** (Multiply transition model, use **numerical integration**)
 - Obtain k Gaussians
 - **Roll-up** (marginalize previous time step)
 - **Project** $k.m$ Gaussians into m' Gaussians $p(X_i | o_{1:i+1})$

Assumed density filtering

- Examples of very important **assumed density filtering**:

- Non-linear KF
- Approximate inference in switching KF

- General picture:

- Select an **assumed density**
 - e.g., single Gaussian, mixture of m Gaussians, ...
- After conditioning, prediction, or roll-up, **distribution no-longer representable with assumed density**
 - e.g., non-linear, mixture of $k.m$ Gaussians,...
- **Project** back into assumed density
 - e.g., numerical integration, collapsing,...

When non-linear KF is not good enough

- Sometimes, distribution in non-linear KF is not approximated well as a single Gaussian
 - e.g., a banana-like distribution

- Assumed density filtering:
 - Solution 1: **reparameterize problem** and solve as a **single Gaussian**
 - Solution 2: more typically, **approximate as a mixture of Gaussians**

Distributed Simultaneous Localization and Tracking

[Funiak, Guestrin, Paskin, Sukthankar '05]

- Place cameras around an environment, don't know where they are
- Could measure all locations, but requires lots of grad. student time
- Intuition:
 - A person walks around
 - If camera 1 sees person, then camera 2 sees person, learn about relative positions of cameras

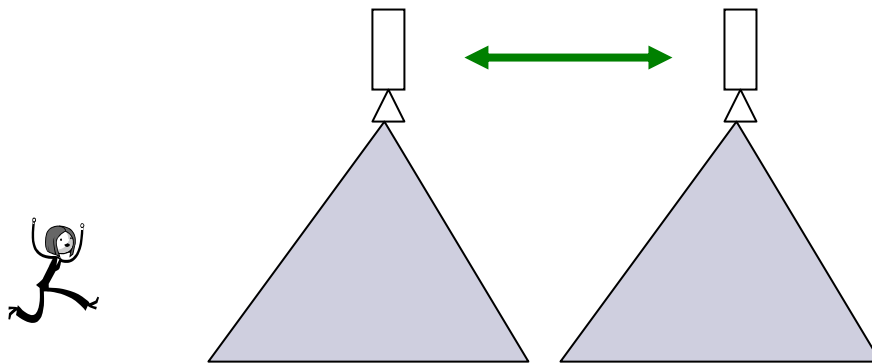

Donut and Banana distributions

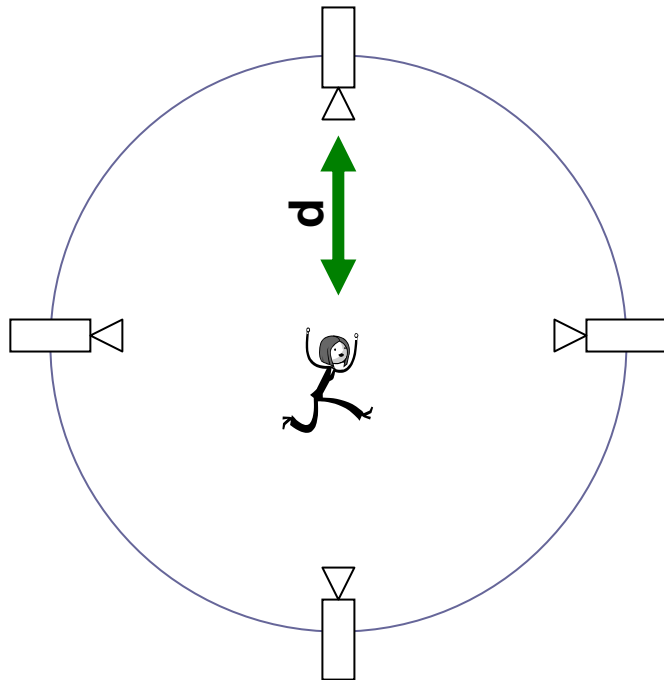

- Observe person at distance d
- Camera could be anywhere in a ring

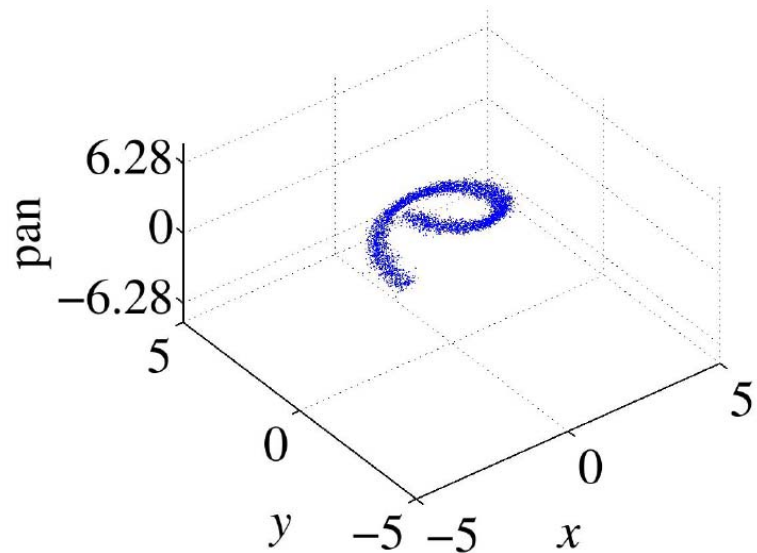

Gaussians represent “balls”

True distribution

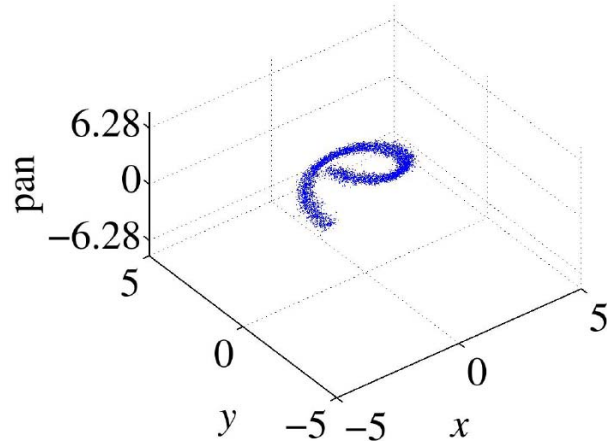

Gaussian approximation

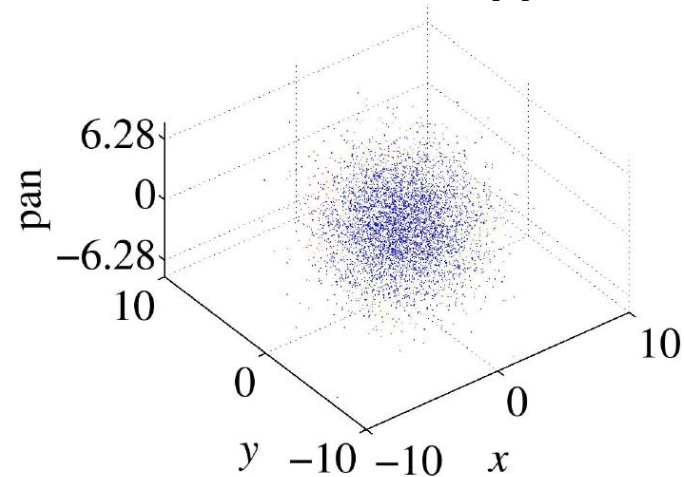

- Gaussian approximation leads to poor results
- Can't apply standard Kalman filter ☹️
- Or can we... 😊

Reparameterized KF for SLAT

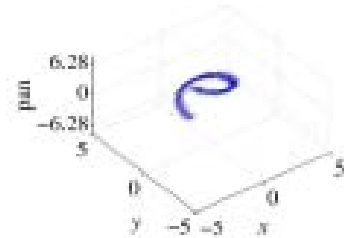
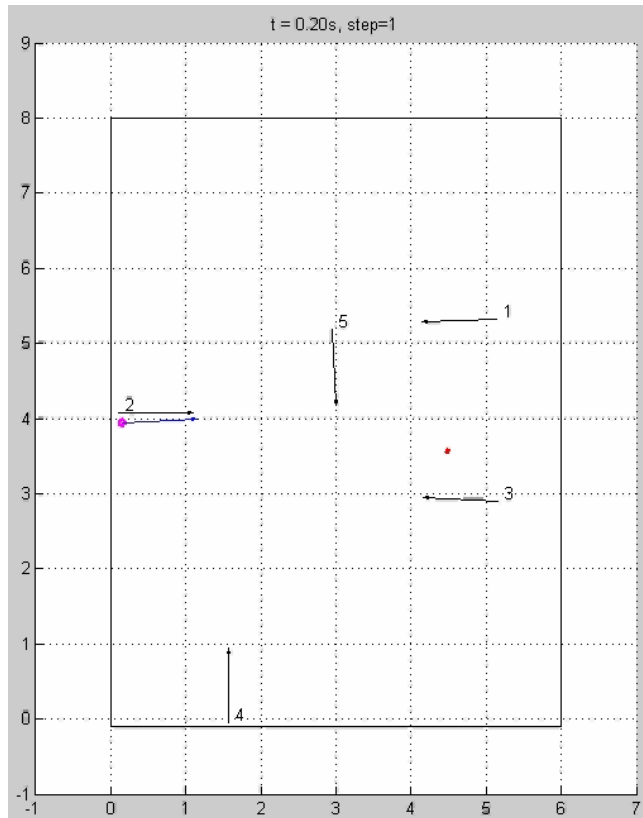

(a) true posterior

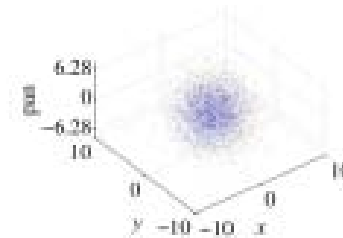

(b) Gaussian in absolute parameters

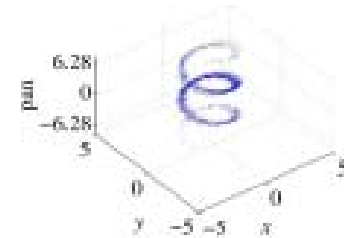

(c) Gaussian in relative parameters

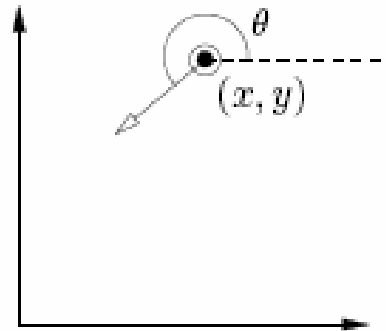

(a) absolute parameters

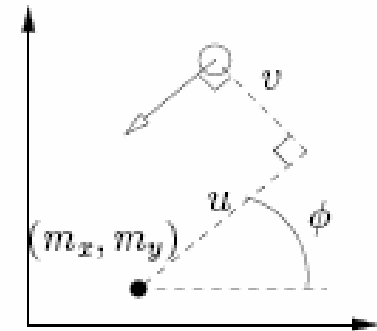

(b) ROP parameters

Example of KF – SLAT

Simultaneous Localization and Tracking

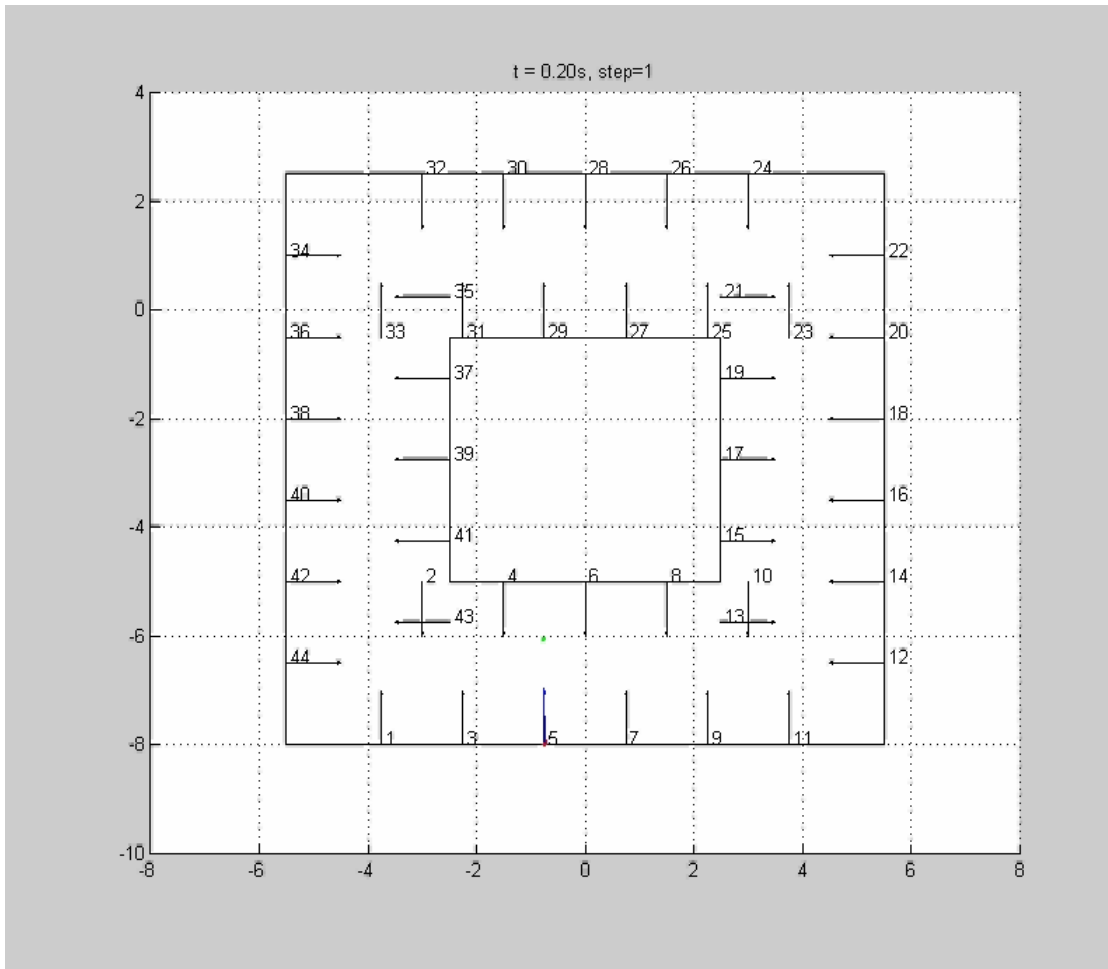

When a single Gaussian ain't good enough

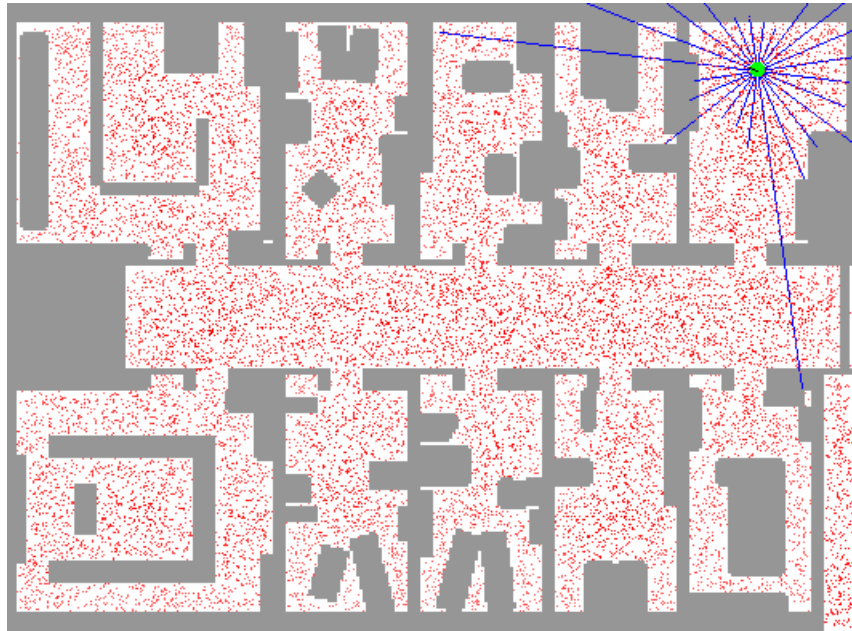

[Fox et al.]

- Sometimes, smart parameterization is not enough
 - Distribution has multiple hypothesis
- Possible solutions
 - Sampling – particle filtering
 - Mixture of Gaussians
 - ...
- Quick overview of one such solution...

Approximating non-linear KF with mixture of Gaussians

- Robot example:
- $P(X_i)$ is a Gaussian, $P(X_{i+1})$ is a banana
- Approximate $P(X_{i+1})$ as a mixture of m Gaussians
 - e.g., using discretization, sampling,...
- Problem:
 - $P(X_{i+1})$ as a mixture of m Gaussians
 - $P(X_{i+2})$ is m bananas
- One solution:
 - Apply collapsing algorithm to project m bananas in m' Gaussians

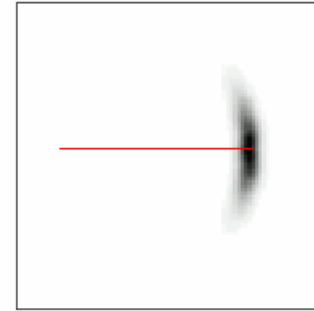

What you need to know about switching Kalman filters

■ Kalman filter

- Probably most used BN
- Assumes Gaussian distributions
- Equivalent to linear system
- Simple matrix operations for computations

■ Non-linear Kalman filter

- Usually, observation or motion model not CLG
- Use numerical integration to find Gaussian approximation

■ Switching Kalman filter

- Hybrid model – discrete and continuous vars.
- Represent belief as mixture of Gaussians
- Number of mixture components grows exponentially in time
- Approximate each time step with fewer components

■ Assumed density filtering

- Fundamental abstraction of most algorithms for dynamical systems
- Assume representation for density
- Every time density not representable, project into representation

More than just a switching KF

- Switching KF selects among k motion models
- Discrete variable can depend on past
 - Markov model over hidden variable

- What if k is really large?
 - Generalize HMMs to large number of variables

Dynamic Bayesian network (DBN)

- HMM defined by
 - Transition model $P(X_{t+1}|X_t)$
 - Observation model $P(O_t|X_t)$
 - Starting state distribution $P(X_0)$
- DBN – Use Bayes net to represent each of these compactly
 - Starting state distribution $P(X_0)$ is a BN
 - (silly) e.g, performance in grad. school DBN
 - Vars: Happiness, Productivity, Hirablility, Fame
 - Observations: Paper, Schmooze

Transition Model:

Two Time-slice Bayes Net (2-TBN)

- Process over vars. \mathbf{X}
- 2-TBN: represents transition and observation models $P(\mathbf{X}_{t+1}, \mathbf{O}_{t+1} | \mathbf{X}_t)$
 - \mathbf{X}_t are *interface variables* (don't represent distribution over these variables)
 - As with BN, exponential reduction in representation complexity

Unrolled DBN



- Start with $P(X_0)$
- For each time step, add vars as defined by 2-TBN

“Sparse” DBN and fast inference

~~“Sparse” DBN  Fast inference~~

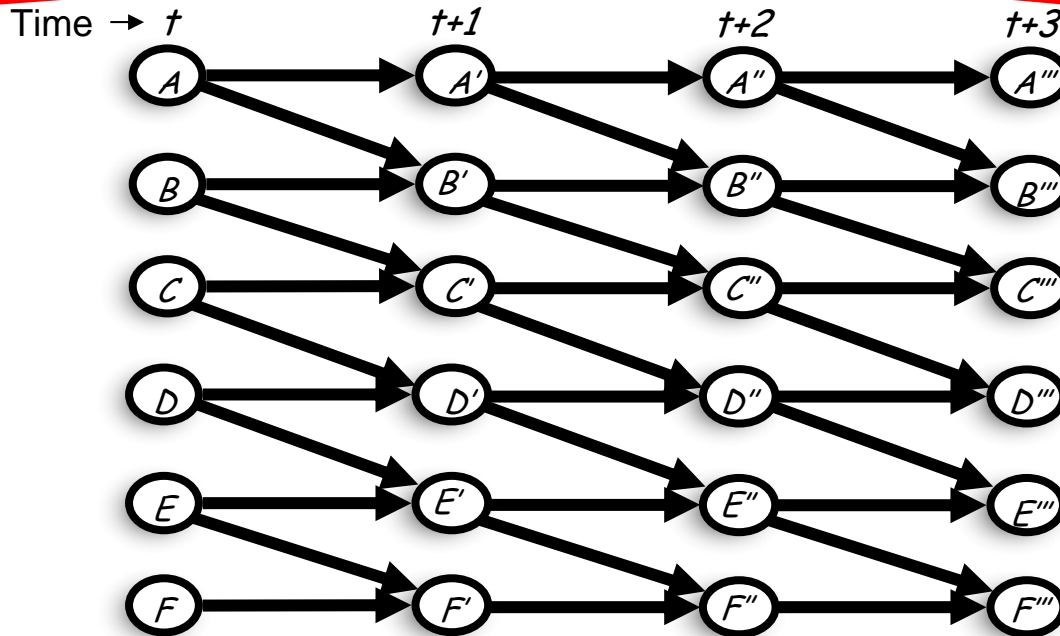

“Sparse” DBN and fast inference 1

Structured representation of belief often yields good approximate

“Sparse” DBN  Fast inference

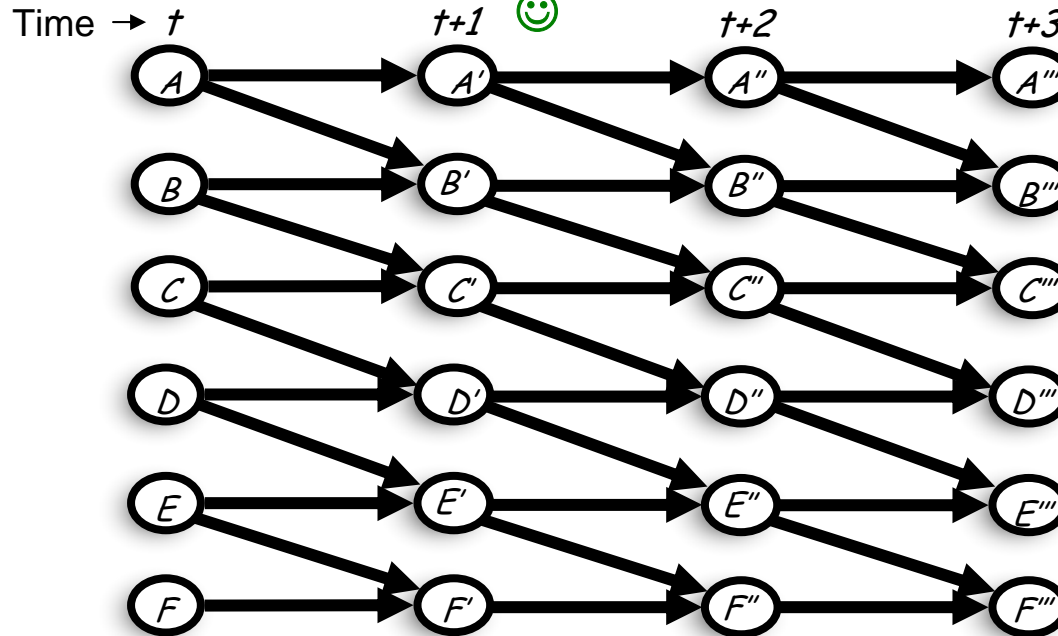

BK Algorithm for approximate DBN inference

[Boyen, Koller '98]

- Assumed density filtering:

- Choose a factored representation \hat{b} for the belief state
- Every time step, belief not representable with \hat{b} , project into representation

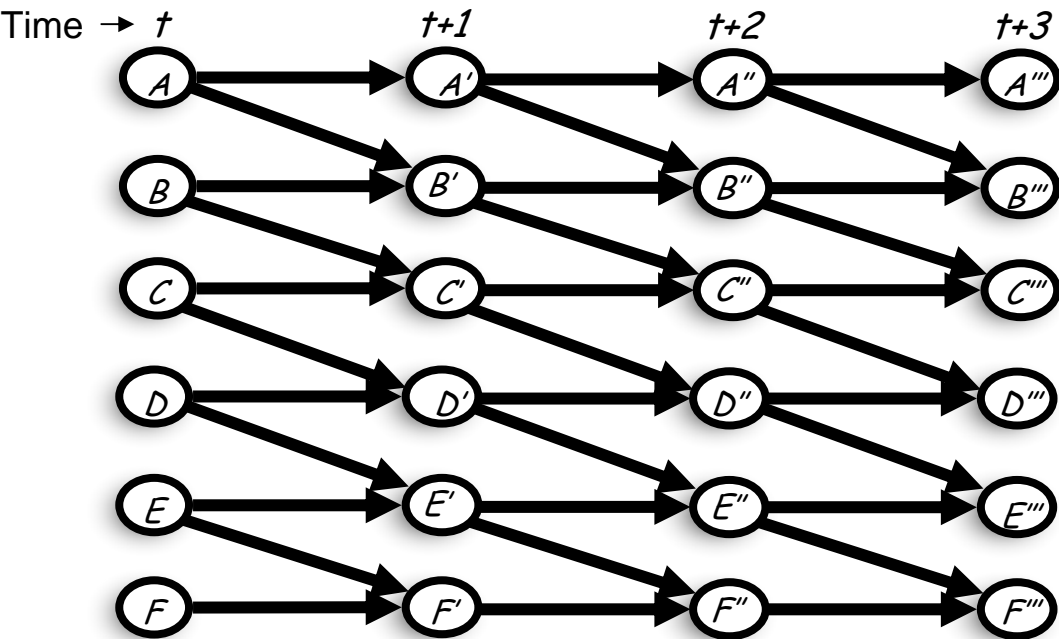

Computing factored belief state in the next time step

- Introduce observations in current time step

- Use J-tree to calibrate time t beliefs

- Compute $t+1$ belief, project into approximate belief state

- marginalize into desired factors
- corresponds to KL projection

- Equivalent to computing marginals over factors directly

- For each factor in $t+1$ step belief
 - Use variable elimination

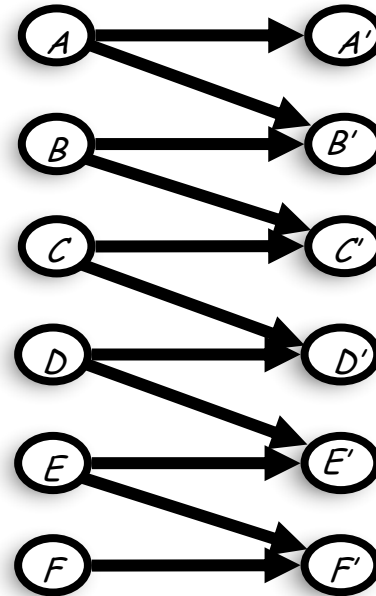

Error accumulation



- Each time step, projection introduces error
- Will error add up?
 - causing unbounded approximation error as $t \rightarrow \infty$

Contraction in Markov process



BK Theorem



- Error does not grow unboundedly!

Example – BAT network [Forbes et al.]

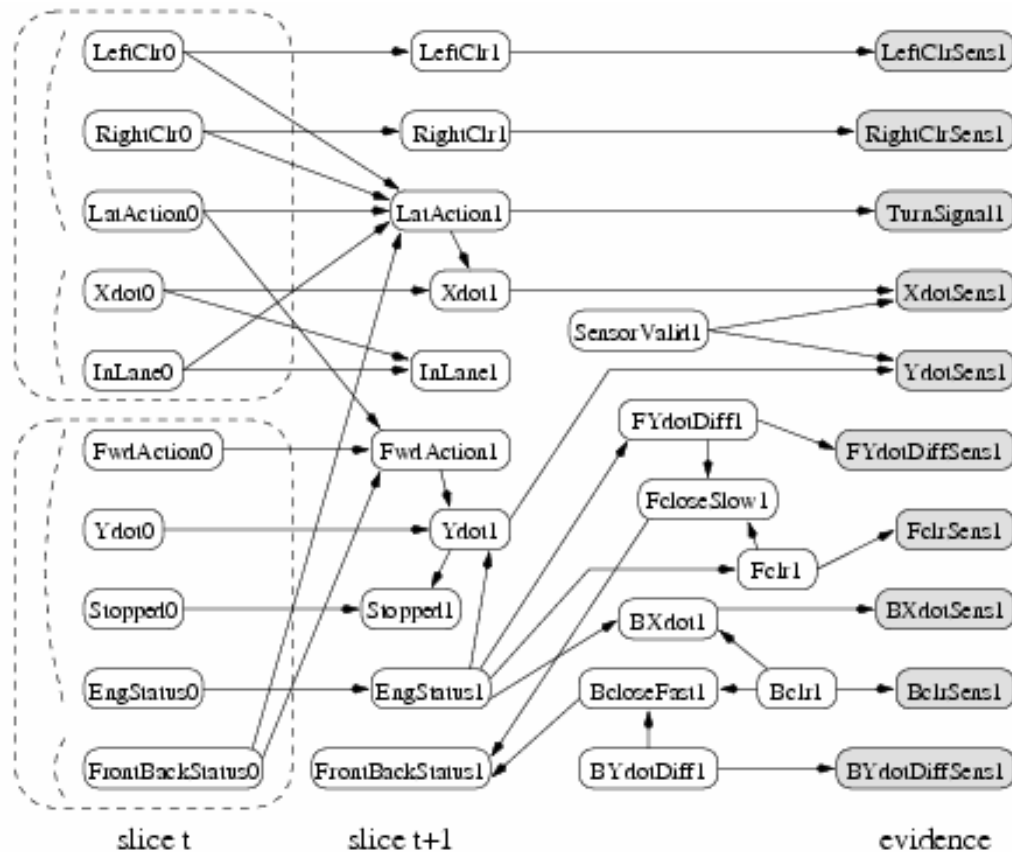

BK results [Boyen, Koller '98]

Typical evolution of error

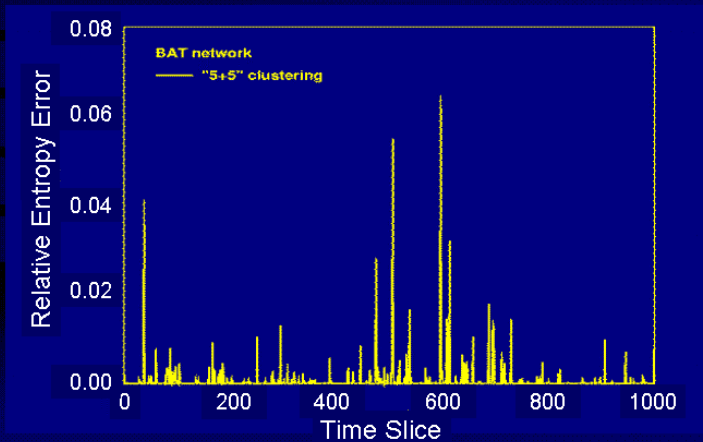

Comparing partitions

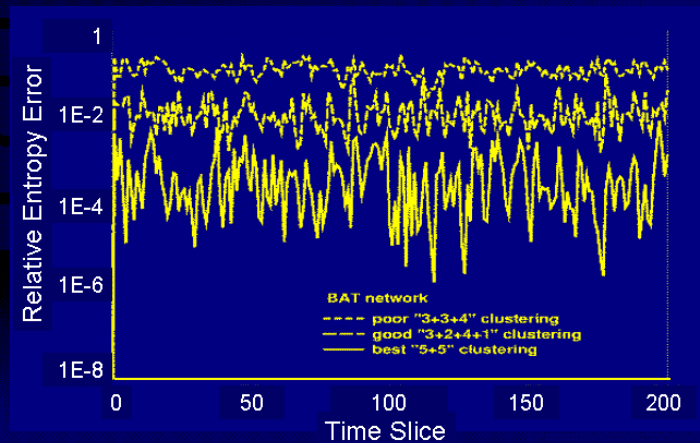

Thin Junction Tree Filters [Paskin '03]

- BK assumes fixed approximation clusters
- TJTF adapts clusters over time
 - attempt to minimize projection error

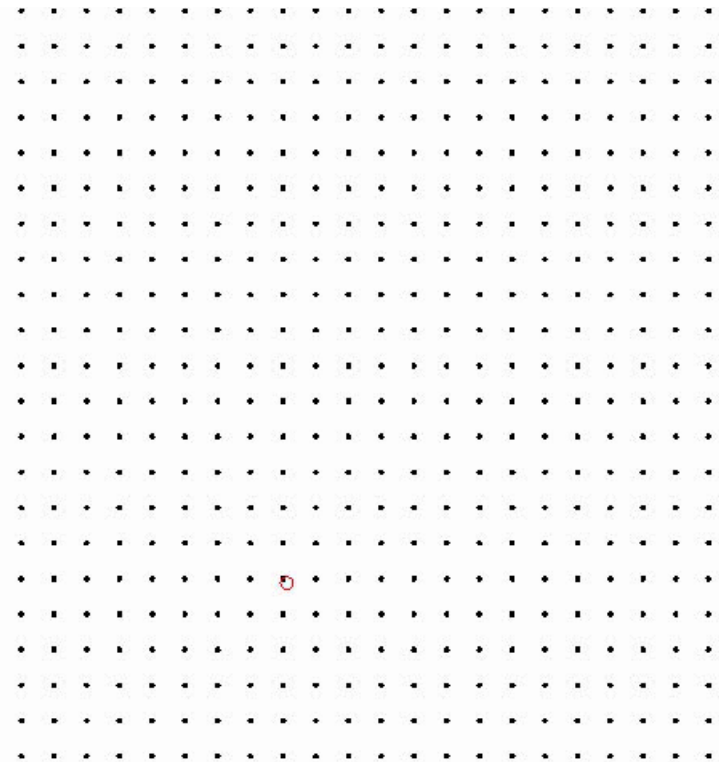

Hybrid DBN (many continuous and discrete variables)

- DBN with large number of discrete and continuous variables
- # of mixture of Gaussian components blows up in one time step!
- Need many smart tricks...
 - e.g., see Lerner Thesis



Figure 10.1: The prototype RWGS system

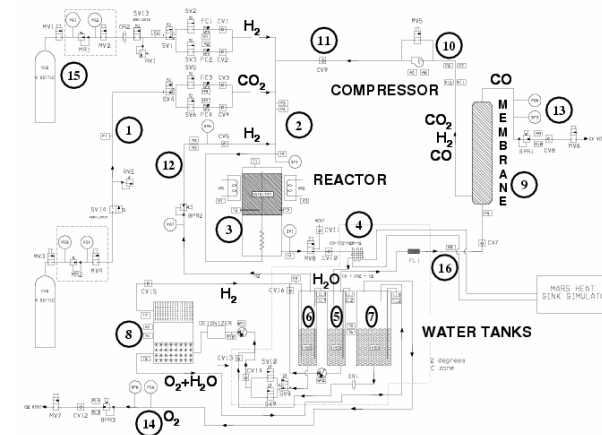

Figure 10.2: The RWGS schematic

Reverse Water Gas Shift System (RWGS) [Lerner et al. '02]

DBN summary



- DBNs
 - factored representation of HMMs/Kalman filters
 - sparse representation does not lead to efficient inference
- Assumed density filtering
 - BK – factored belief state representation is assumed density
 - Contraction guarantees that error does not blow up (but could still be large)
 - Thin junction tree filter adapts assumed density over time
 - Extensions for hybrid DBNs