

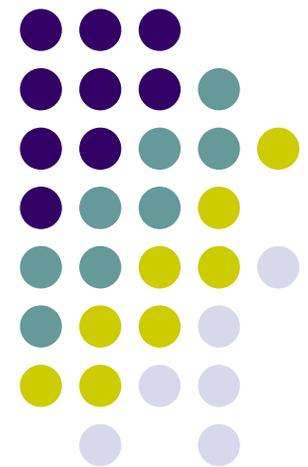

# Probabilistic Graphical Models

## Mean Field Approximation & Topic Models



Eric Xing

Lecture 13, February 26, 2016

Reading: See class website





# Recall: The Theory Behind LBP

- But we do not optimize  $q(\mathbf{X})$  explicitly, focus on the set of beliefs

- *e.g.*,  $b = \{b_{i,j} = \tau(x_i, x_j), b_i = \tau(x_i)\}$

- Relax the optimization problem

- approximate objective:

$$H_q \approx F(b)$$

- relaxed feasible set:

$$\mathcal{M} \rightarrow \mathcal{M}_o \quad (\mathcal{M}_o \supseteq \mathcal{M})$$

$$b^* = \arg \min_{b \in \mathcal{M}_o} \left\{ \langle E \rangle_b + F(b) \right\}$$

- The loopy BP algorithm:

- a fixed point iteration procedure that tries to solve  $b^*$



# Recall: The Theory Behind LBP

- But we do not optimize  $q(\mathbf{X})$  explicitly, focus on the set of beliefs

- *e.g.*,  $b = \{b_{i,j} = \tau(x_i, x_j), b_i = \tau(x_i)\}$

- Relax the optimization problem

- approximate objective:  $H_{\text{Betha}} = H(b_{i,j}, b_i)$

- relaxed feasible set:  $\mathcal{M}_o = \{ \tau \geq 0 \mid \sum_{x_i} \tau(x_i) = 1, \sum_{x_i} \tau(x_i, x_j) = \tau(x_j) \}$

$$b^* = \arg \min_{b \in \mathcal{M}_o} \left\{ \langle E \rangle_b + F(b) \right\}$$

- The loopy BP algorithm:

- a fixed point iteration procedure that tries to solve  $b^*$



# Mean Field Approximation



# Mean Field Methods

- Optimize  $q(\mathbf{X}_H)$  in the space of tractable families
  - *i.e.*, subgraph of  $G_p$  over which exact computation of  $H_q$  is feasible
- Tightening the optimization space

- exact objective:  $H_q$
- tightened feasible set:  $Q \rightarrow \mathcal{T} \quad (\mathcal{T} \subseteq Q)$

$$q^* = \arg \min_{q \in \mathcal{T}} \langle E \rangle_q - H_q$$



# Variational Principle

---

- **Exact** variational formulation

$$A(\theta) = \sup_{\mu \in \mathcal{M}} \{ \theta^T \mu - A^*(\mu) \}$$

- $\mathcal{M}$ : the marginal polytope, difficult to characterize
- $A^*$ : the negative entropy function, no explicit form
- Mean field method: **non-convex inner bound** and **exact form of entropy**
- Bethe approximation and loopy belief propagation: **polyhedral outer bound** and **non-convex Bethe approximation**



# Mean Field Methods

- For a given tractable subgraph  $F$ , a **subset** of canonical parameters is

$$\mathcal{M}(F; \phi) := \{\tau \in \mathbb{R}^d \mid \tau = \mathbb{E}_\theta[\phi(X)] \text{ for some } \theta \in \Omega(F)\}$$

- Inner approximation

$$\mathcal{M}(F; \phi)^o \subseteq \mathcal{M}(G; \phi)^o$$

- Mean field solves the relaxed problem

$$\max_{\tau \in \mathcal{M}_F(G)} \{\langle \tau, \theta \rangle - A_F^*(\tau)\}$$

- $A_F^* = A^*|_{\mathcal{M}_F(G)}$  is the **exact** dual function restricted to  $\mathcal{M}_F(G)$



# Tractable Subgraphs

- For an exponential family with sufficient statistics  $\phi$  defined on graph  $G$ , the set of realizable mean parameter set

$$\mathcal{M}(G; \phi) := \{\mu \in \mathbb{R}^d \mid \exists p \text{ s.t. } \mathbb{E}_p[\phi(X)] = \mu\}$$

- Idea: restrict  $p$  to a subset of distributions associated with a **tractable** subgraph

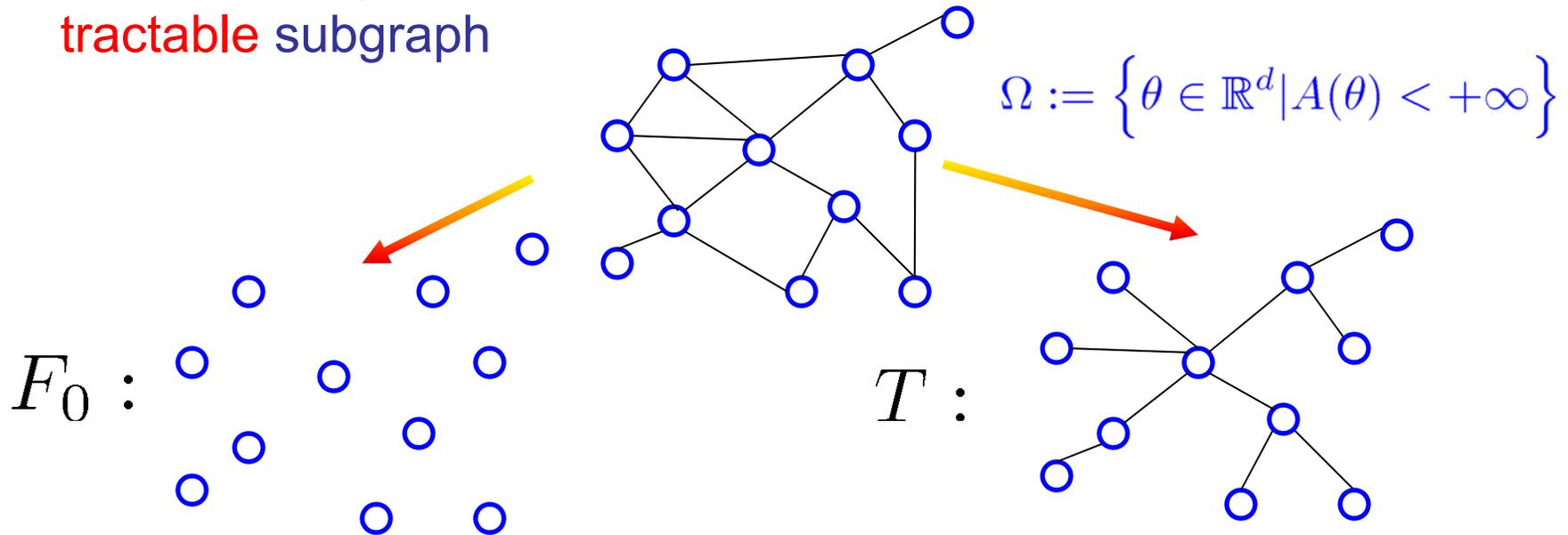

$$\Omega(F_0) := \{\theta \in \Omega \mid \theta_{(s,t)} = 0 \forall (s,t) \in E\}. \quad \Omega(T) := \{\theta \in \Omega \mid \theta_{(s,t)} = 0 \forall (s,t) \notin E(T)\}.$$





## Example: Naïve Mean Field for Ising Model

- Ising model in  $\{0,1\}$  representation

$$p(x) \propto \exp \left\{ \sum_{s \in V} x_s \theta_s + \sum_{(s,t) \in E} x_s x_t \theta_{st} \right\}$$

- Mean parameters

$$\mu_s = E_p[X_s] = P[X_s = 1] \quad \text{for all } s \in V, \text{ and}$$

$$\mu_{st} = E_p[X_s X_t] = P[(X_s, X_t) = (1, 1)] \quad \text{for all } (s, t) \in E.$$

- For fully disconnected graph  $F$ ,

$$\mathcal{M}_F(G) := \{ \tau \in \mathbb{R}^{|V|+|E|} \mid 0 \leq \tau_s \leq 1, \forall s \in V, \tau_{st} = \tau_s \tau_t, \forall (s, t) \in E \}$$

- The dual decomposes into sum, one for each node

$$A_F^*(\tau) = \sum_{s \in V} [\tau_s \log \tau_s + (1 - \tau_s) \log(1 - \tau_s)]$$

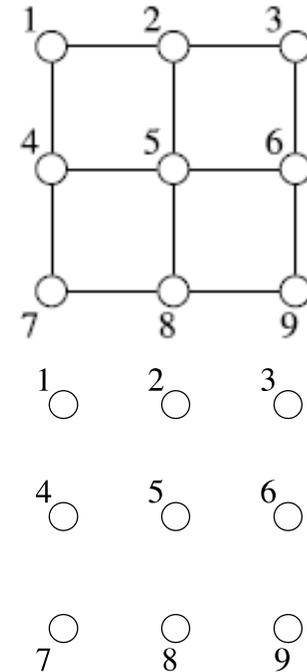

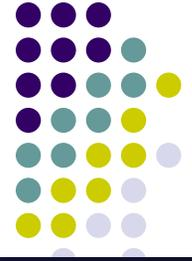

# Naïve Mean Field for Ising Model

- Optimization Problem

$$\max_{\mu \in [0,1]^m} \left\{ \sum_{s \in V} \theta_s \mu_s + \sum_{(s,t) \in E} \theta_{st} \mu_s \mu_t + \sum_{s \in V} H_s(\mu_s) \right\}$$

- Update Rule

$$\mu_s \leftarrow \sigma \left( \theta_s + \sum_{t \in N(s)} \theta_{st} \mu_t \right)$$

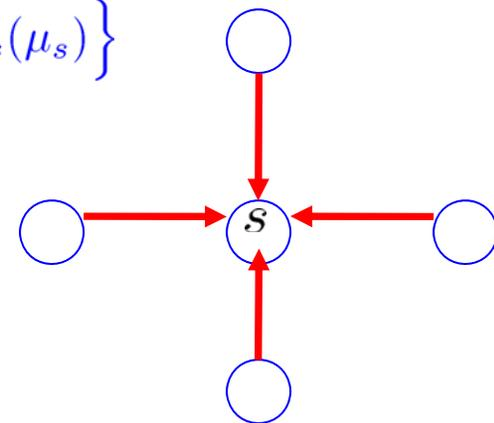

- $\mu_t = p(X_t = 1) = \mathbb{E}_p[X_t]$  resembles “message” sent from node  $t$  to  $s$
- $\{\mathbb{E}_p[X_t], t \in N(s)\}$  forms the “mean field” applied to  $s$  from its neighborhood
- Also yields lower bound on log partition function

$$KL(Q \parallel P) = -H_Q(X) - \sum_{f_a \in F} E_Q \log f_a(X_a) + \log Z$$

# Geometry of Mean Field



- Mean field optimization is always **non-convex** for any exponential family in which the state space  $\mathcal{X}^m$  is finite

- Recall the marginal polytope is a convex hull

$$\mathcal{M}(G) = \text{conv}\{\phi(e); e \in \mathcal{X}^m\}$$

- $\mathcal{M}_F(G)$  contains all the extreme points
  - If it is a **strict** subset, then it must be non-convex

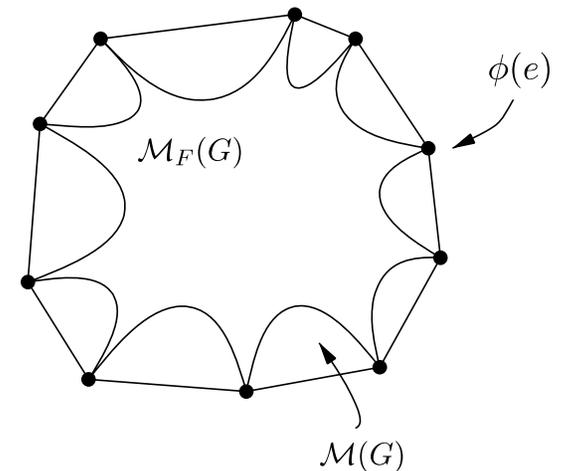

- Example: two-node Ising model

$$\mathcal{M}_F(G) = \{0 \leq \tau_1 \leq 1, 0 \leq \tau_2 \leq 1, \tau_{12} = \tau_1\tau_2\}$$

- It has a parabolic cross section along  $\tau_1 = \tau_2$ , hence non-convex

# Cluster-based approx. to the Gibbs free energy

(Wiegerinck 2001,  
Xing *et al* 03,04)



Exact:  $G[p(X)]$  (*intractable*)

Clusters:  $G[\{q_c(X_c)\}]$

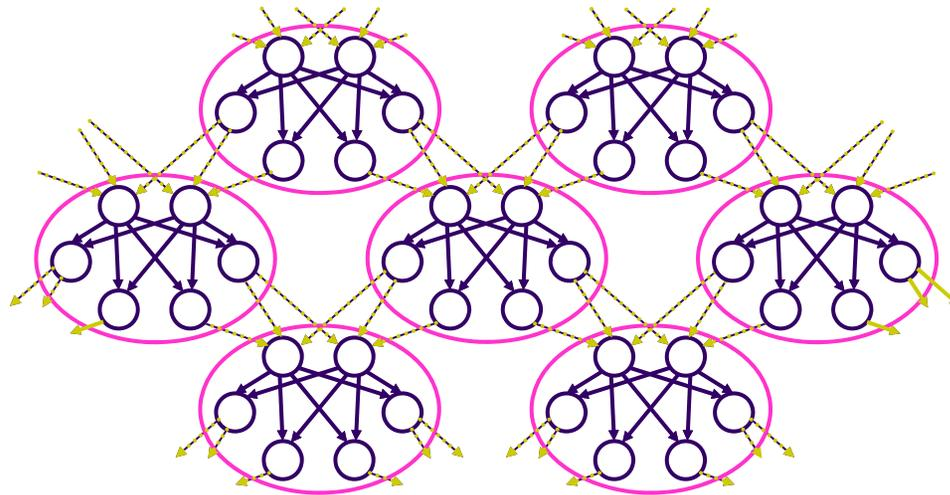

# Mean field approx. to Gibbs free energy

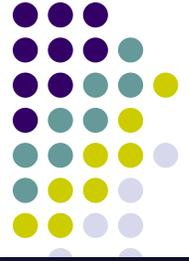

- Given a disjoint clustering,  $\{C_1, \dots, C_l\}$ , of all variables

- Let

$$q(\mathbf{X}) = \prod_i q_i(\mathbf{X}_{C_i}),$$

- Mean-field free energy

$$G_{\text{MF}} = \sum_i \sum_{\mathbf{x}_{C_i}} \prod_i q_i(\mathbf{x}_{C_i}) E(\mathbf{x}_{C_i}) + \sum_i \sum_{\mathbf{x}_{C_i}} q_i(\mathbf{x}_{C_i}) \ln q_i(\mathbf{x}_{C_i})$$

e.g.,  $G_{\text{MF}} = \sum_{i < j} \sum_{x_i x_j} q(x_i) q(x_j) \phi(x_i x_j) + \sum_i \sum_{x_i} q(x_i) \phi(x_i) + \sum_i \sum_{x_i} q(x_i) \ln q(x_i)$  (naïve mean field)

- Will **never** equal to the exact Gibbs free energy no matter what clustering is used, but it does **always** define a lower bound of the likelihood
- Optimize each  $q_i(x_c)$ 's.
  - Variational calculus ...
  - Do inference in each  $q_i(x_c)$  using any tractable algorithm

# The Generalized Mean Field theorem



**Theorem:** The optimum GMF approximation to the cluster marginal is isomorphic to the cluster posterior of the original distribution given internal evidence and its generalized mean fields:

$$q_i^*(\mathbf{X}_{H,C_i}) = p(\mathbf{X}_{H,C_i} \mid \mathbf{x}_{E,C_i}, \langle \mathbf{X}_{H,MB_i} \rangle_{q_{j \neq i}})$$

GMF algorithm: Iterate over each  $q_i$

# A generalized mean field algorithm

[xing *et al.* UAI 2003]

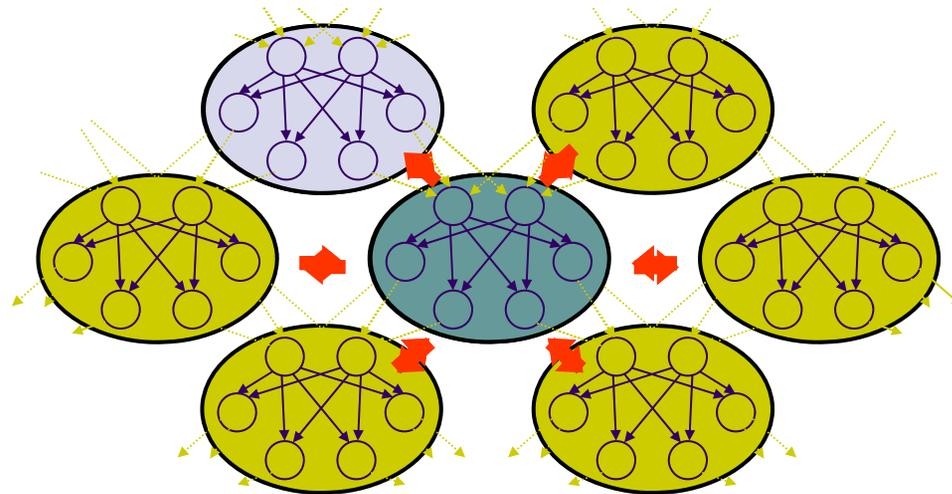

# A generalized mean field algorithm

[xing *et al.* UAI 2003]

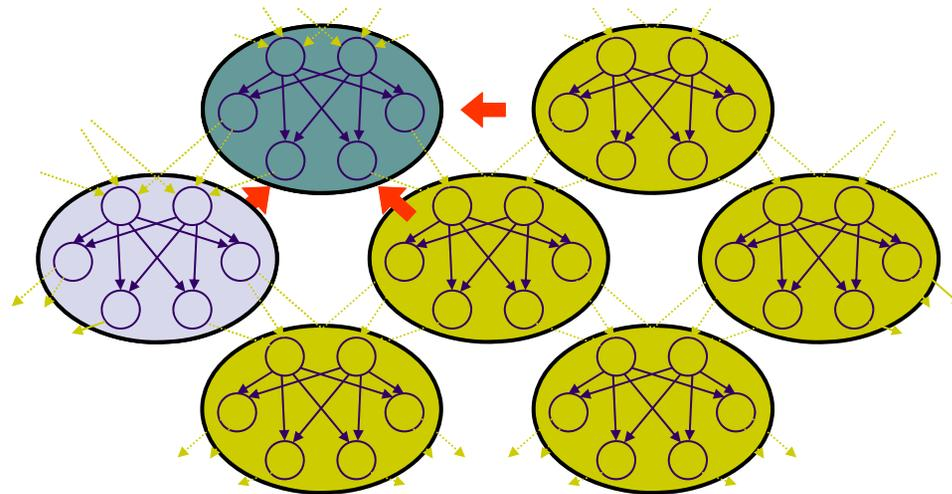



# Convergence theorem

---



**Theorem:** The GMF algorithm is guaranteed to converge to a local optimum, and provides a lower bound for the likelihood of evidence (or partition function) the model.

# The naive mean field approximation



- Approximate  $p(\mathbf{X})$  by fully factorized  $q(\mathbf{X}) = \prod_i q_i(X_i)$
- For Boltzmann distribution  $p(\mathbf{X}) = \exp\{\sum_{i < j} q_{ij} X_i X_j + q_{i0} X_i\} / Z$  :

mean field equation:

$$q_i(X_i) = \exp\left\{\theta_{i0} X_i + \sum_{j \in \mathcal{N}_i} \theta_{ij} X_i \langle X_j \rangle_{q_j} + A_i\right\}$$
$$= p(X_i | \{\langle X_j \rangle_{q_j} : j \in \mathcal{N}_i\})$$

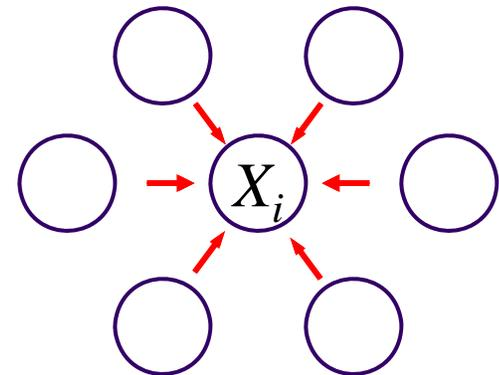

- $\langle X_j \rangle_{q_j}$  resembles a “message” sent from node  $j$  to  $i$
- $\{\langle X_j \rangle_{q_j} : j \in \mathcal{N}_i\}$  forms the “mean field” applied to  $X_i$  from its neighborhood

# Example 1: Generalized MF approximations to Ising models

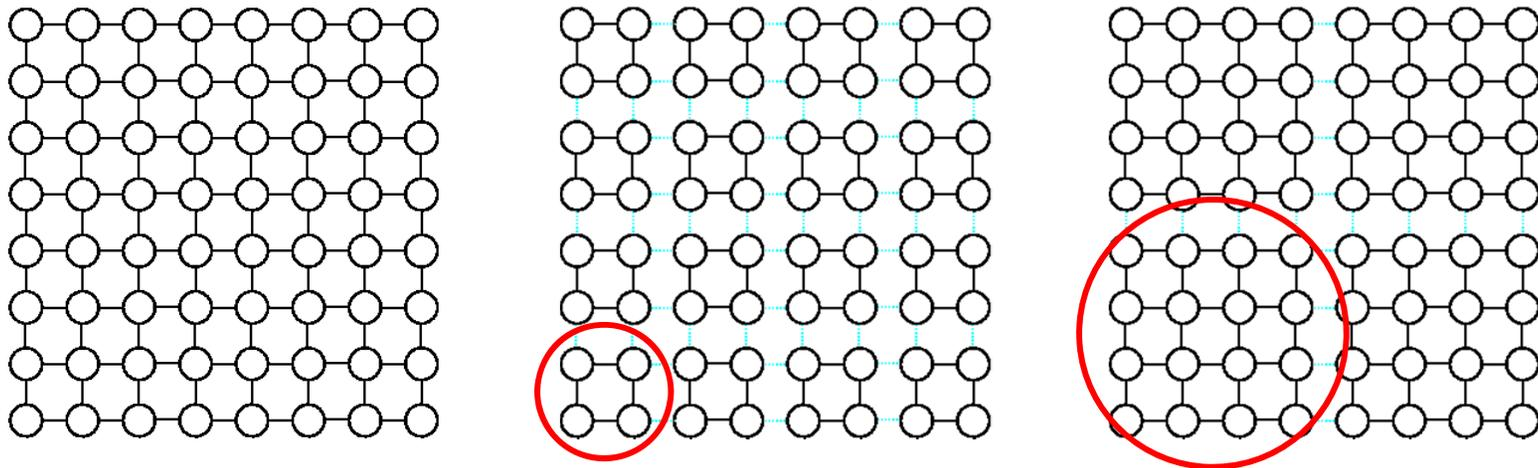

Cluster marginal of a square block  $C_k$ :

$$q(X_{C_k}) \propto \exp \left\{ \sum_{i,j \in C_k} \theta_{ij} X_i X_j + \sum_{i \in C_k} \theta_{i0} X_i + \sum_{\substack{i \in C_k, j \in MB_k, \\ k' \in MBC_k}} \theta_{ij} X_i \langle X_j \rangle_{q(X_{C_{k'}})} \right\}$$

Virtually a reparameterized Ising model of small size.

# GMF approximation to Ising models

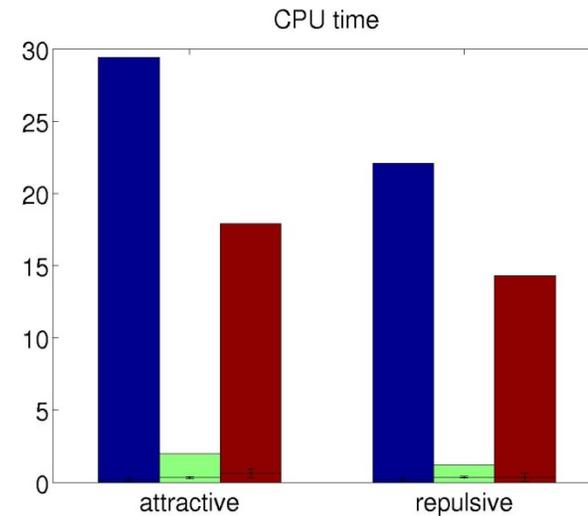
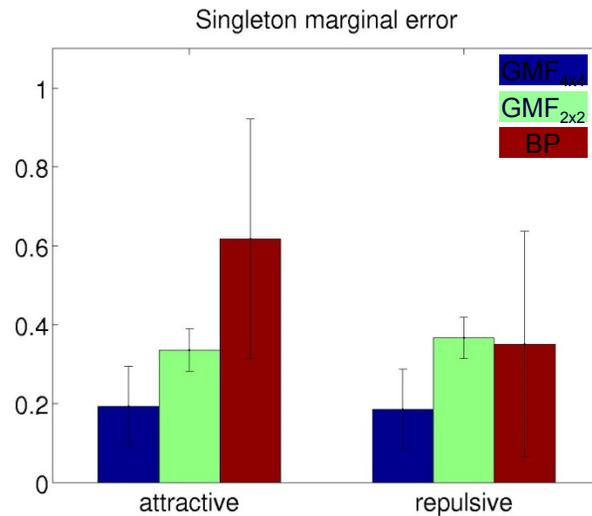
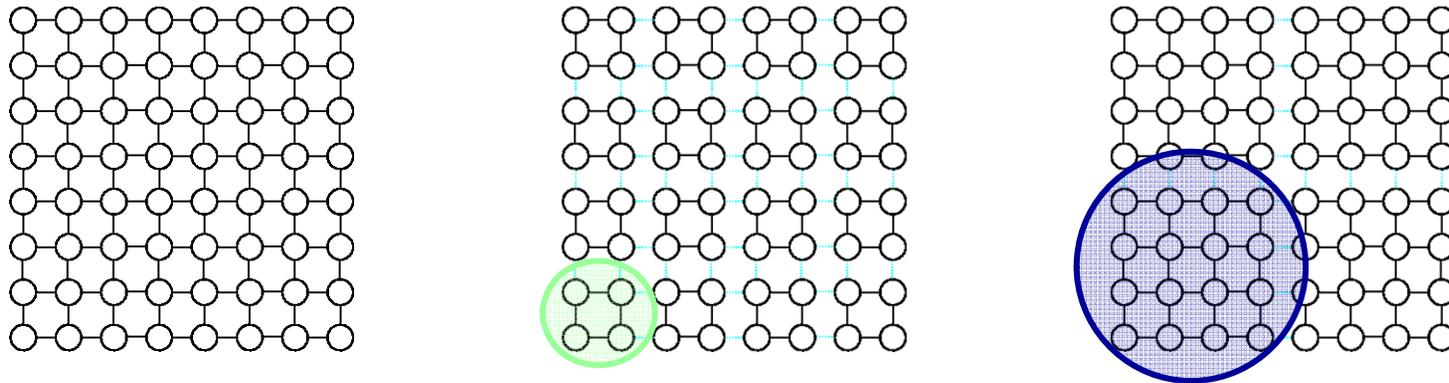

© Eric Xing @ CMU, 2005-2016  
 Attractive coupling: positively weighted  
 Repulsive coupling: negatively weighted

# Example 2: Sigmoid belief network

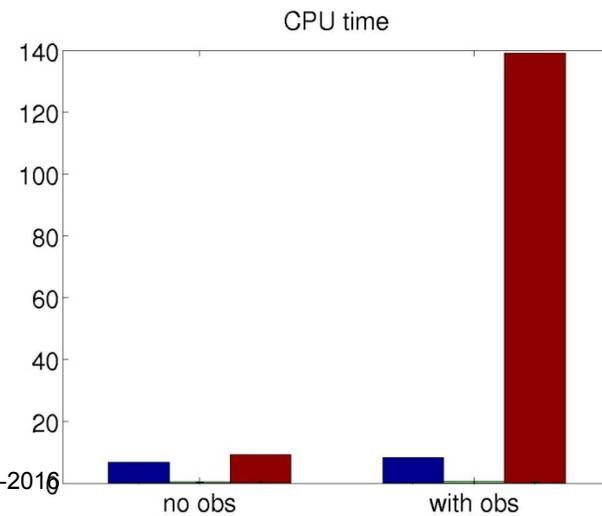
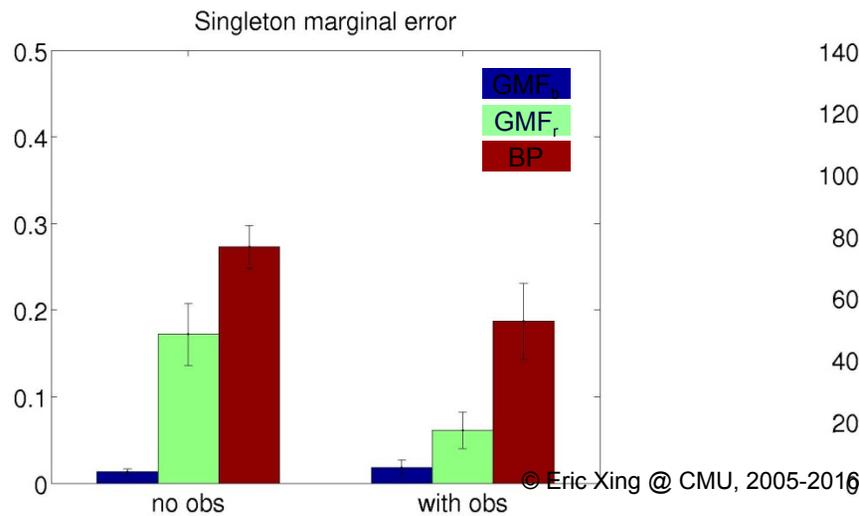
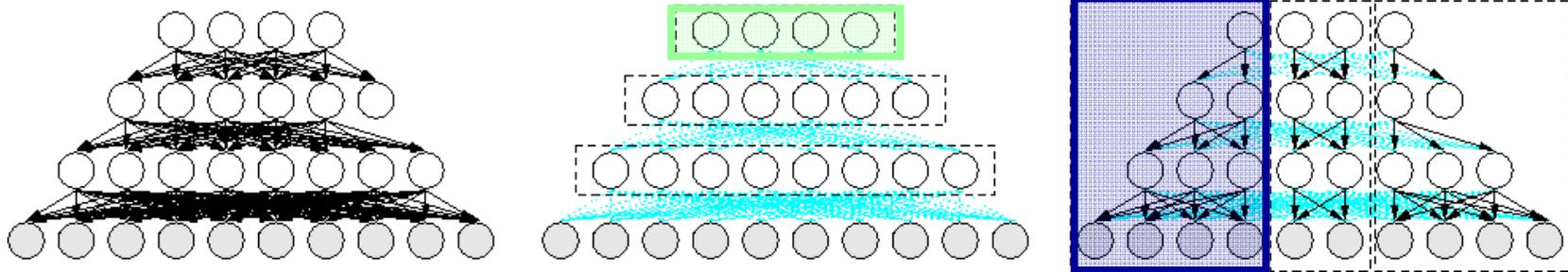



# Example 3: Factorial HMM

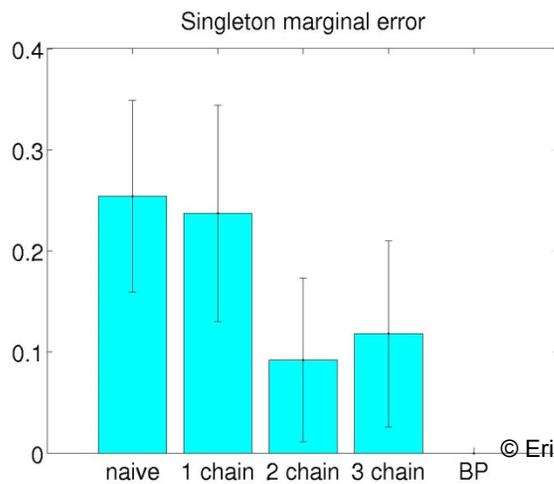
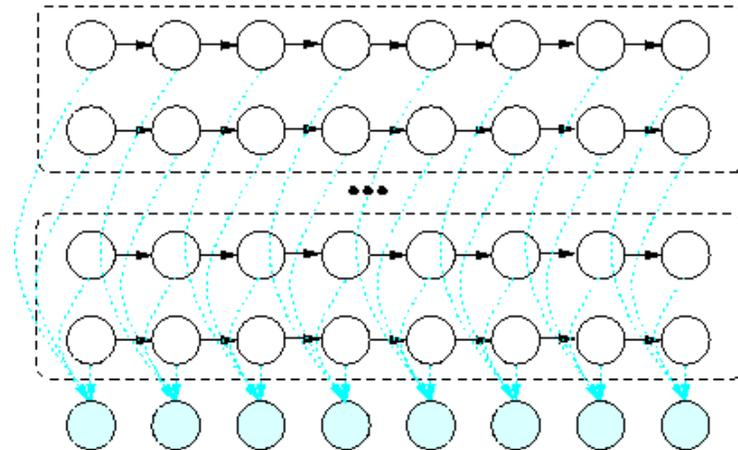
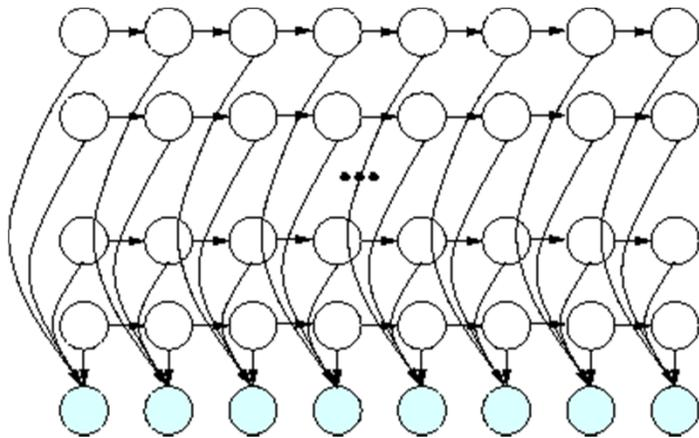

© Eric Xing @ CMU, 2005-2016

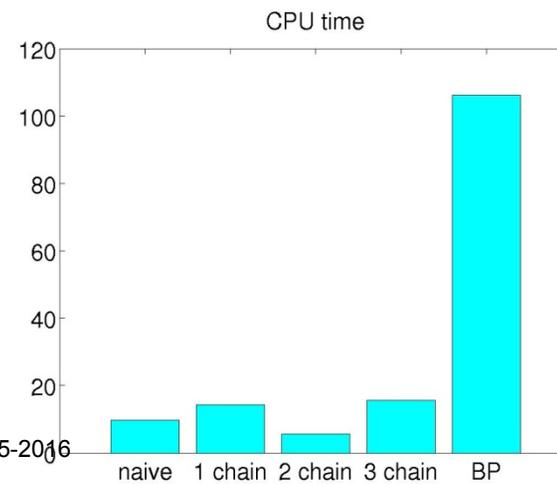

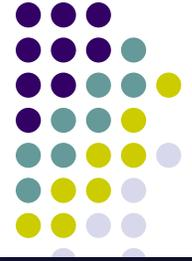

# Automatic Variational Inference

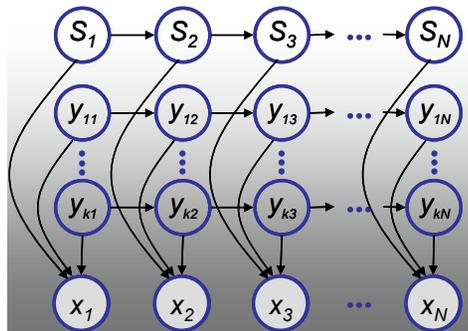

**fHMM**

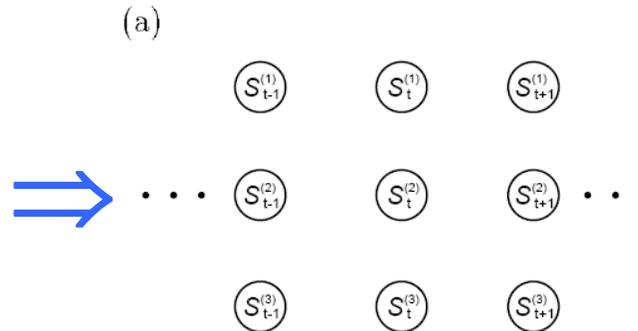

**Mean field approx.**

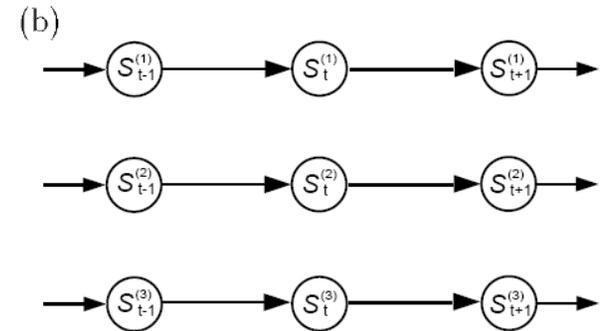

**Structured variational approx.**

- Currently for each new model we have to
  - derive the variational update equations
  - write application-specific code to find the solution
- Each can be time consuming and error prone
- Can we build a general-purpose inference engine which automates these procedures?

# Probabilistic Topic Models



- Humans cannot afford to deal with (e.g., search, browse, or measure similarity) a huge number of text documents
- We need computers to help out ...





# How to get started?

- **Here are some important elements to consider before you start:**
  - **Task:**
    - Embedding? Classification? Clustering? Topic extraction? ...
  - **Data representation:**
    - Input and output (e.g., continuous, binary, counts, ...)
  - **Model:**
    - BN? MRF? Regression? SVM?
  - **Inference:**
    - Exact inference? MCMC? Variational?
  - **Learning:**
    - MLE? MCLE? Max margin?
  - **Evaluation:**
    - Visualization? Human interpretability? Perplexity? Predictive accuracy?
- **It is better to consider one element at a time!**

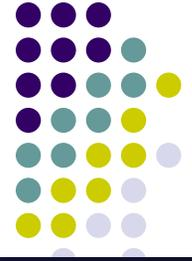

# Tasks: document embedding

- Say, we want to have a mapping ..., so that

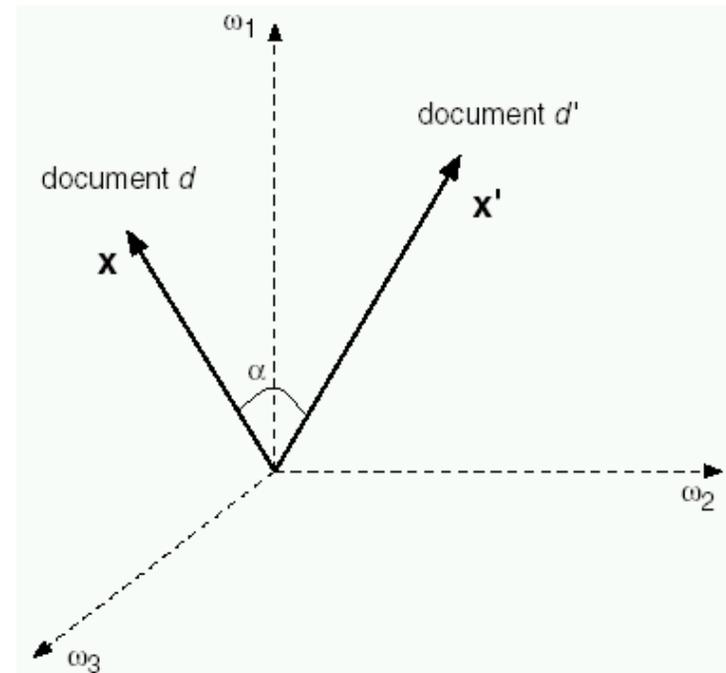

- Compare similarity
- Classify contents
- Cluster/group/categorizing
- Distill semantics and perspectives
- ..

# Summarizing the data using topics



<b>Bayesian modeling</b>	<b>Visual cortex</b>	<b>Education</b>	<b>Market</b>
Bayesian model inference models probability probabilistic Markov prior hidden approach	cortex cortical areas visual area primary connections ventral cerebral sensory	students education learning educational teaching school student skills teacher academic	market economic financial economics markets returns price stock value investment

# See how data changes over time

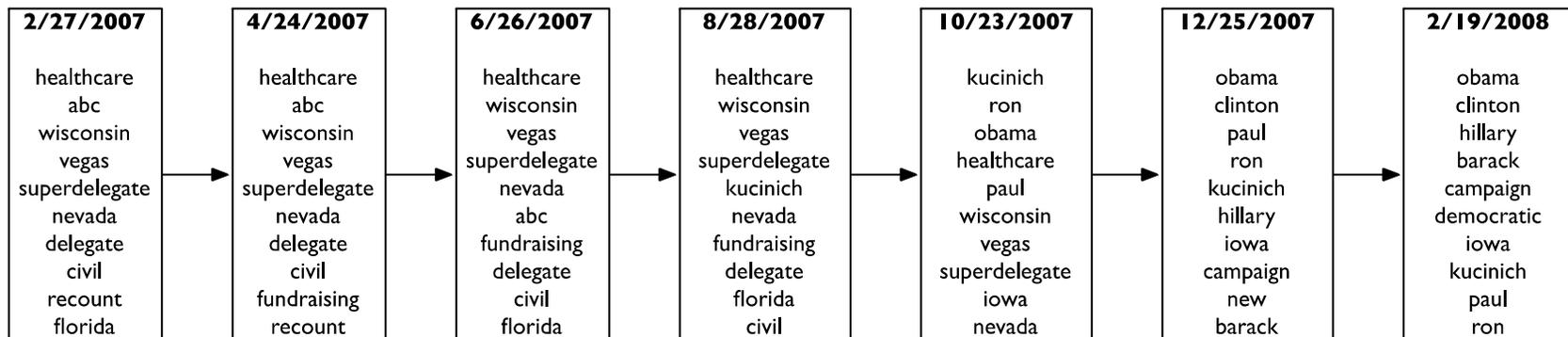



# User interest modeling using topics

User interest profile (adjustable with sliders---Changing these changes recommendations.)

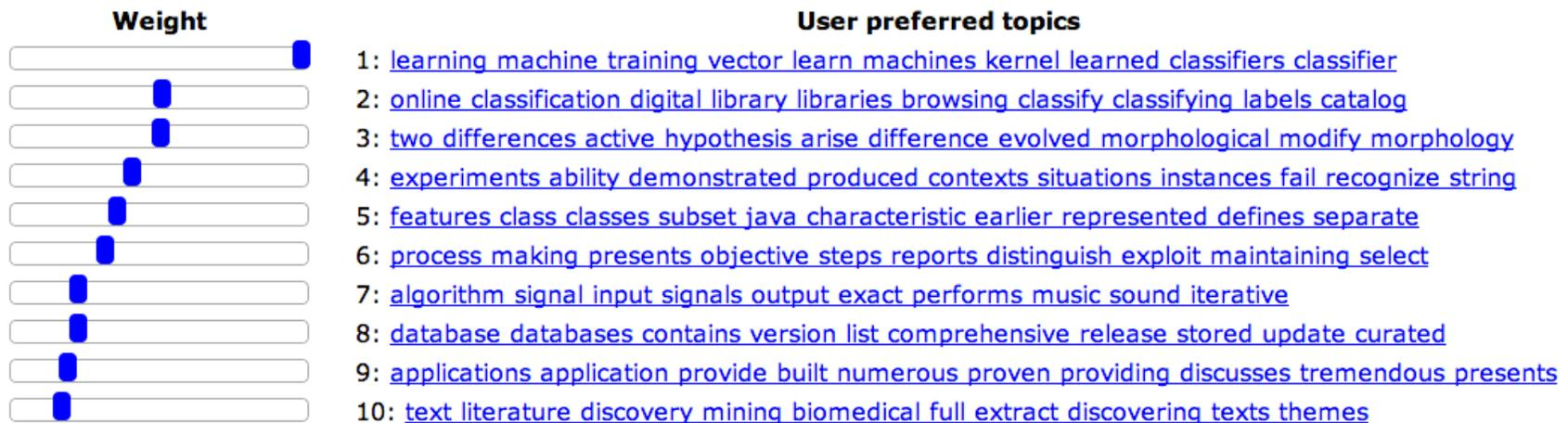

<http://cogito-demos.ml.cmu.edu/cgi-bin/recommendation.cgi>



# Representation:

- Data: Bag of Words Representation

As for the Arabian and Palestinean voices that are against the current negotiations and the so-called peace process, they are not against peace per se, but rather for their well-founded predictions that Israel would NOT give an inch of the West bank (and most probably the same for Golan Heights) back to the Arabs. An 18 months of "negotiations" in Madrid, and Washington proved these predictions. Now many will jump on me saying why are you blaming israelis for no-result negotiations. I would say why would the Arabs stall the negotiations, what do they have to loose ?



- Each document is a vector in the word space
- Ignore the order of words in a document. Only count matters!
- A high-dimensional and sparse representation ( $|V| \gg D$ )
  - Not efficient text processing tasks, e.g., search, document classification, or similarity measure
  - Not effective for browsing

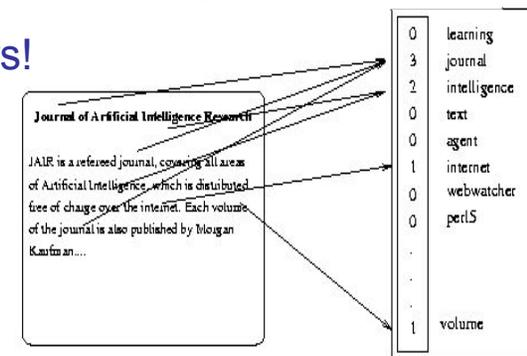

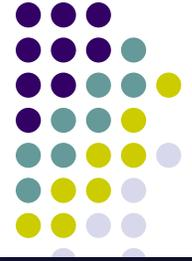

# How to Model Semantic?

- Q: What is it about?
- A: Mainly MT, with syntax, some learning

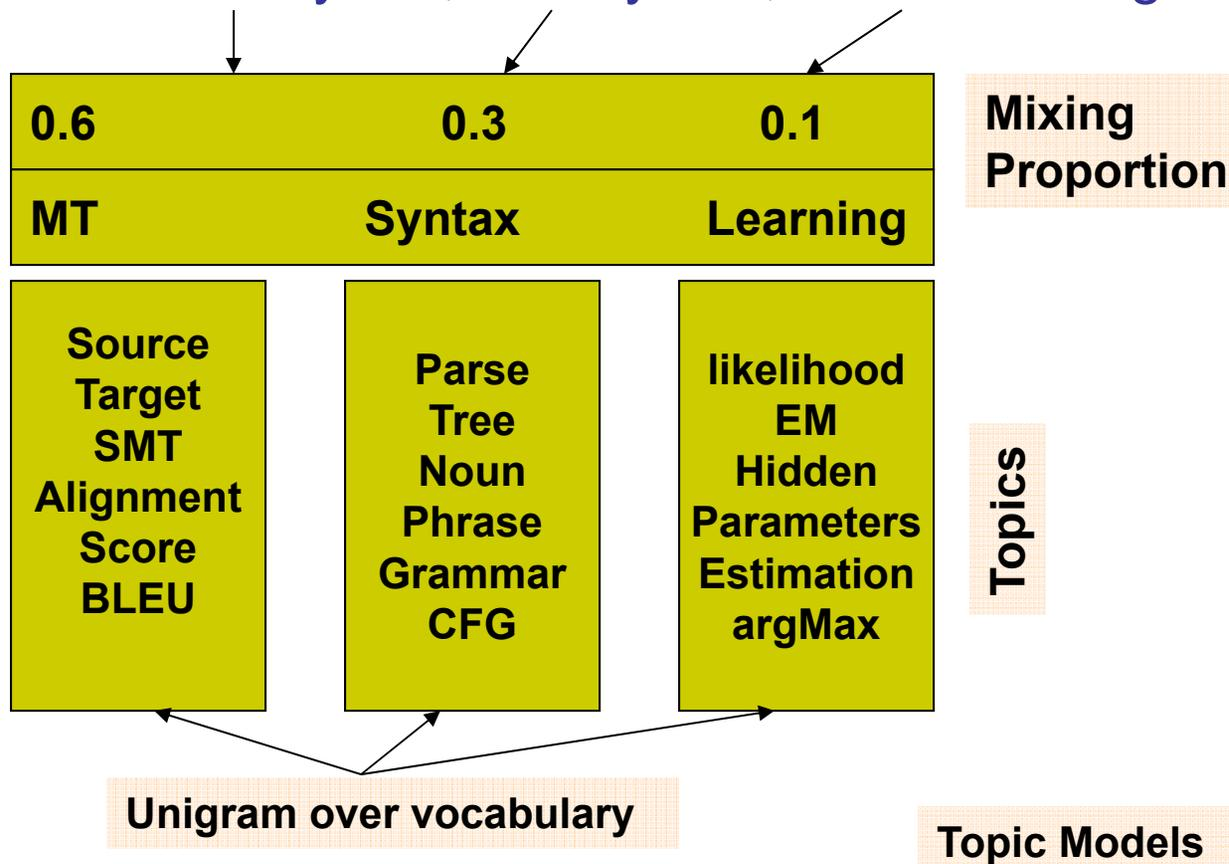

## A Hierarchical Phrase-Based Model for Statistical Machine Translation

We present a statistical phrase-based Translation model that uses *hierarchical phrases*—phrases that contain sub-phrases. The model is formally a synchronous context-free grammar but is learned from a bitext without any syntactic information. Thus it can be seen as a shift to the *formal* machinery of syntax based translation systems without any *linguistic* commitment. In our experiments using BLEU as a metric, the hierarchical Phrase based model achieves a relative Improvement of 7.5% over Pharaoh, a state-of-the-art phrase-based system.

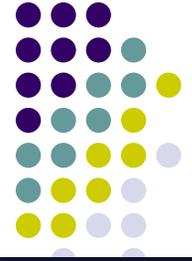

# Why this is Useful?

- Q: What is it about?
- A: Mainly MT, with syntax, some learning

0.6	0.3	0.1
MT	Syntax	Learning

Mixing  
Proportion

- Q: give me similar document?
  - Structured way of browsing the collection
- Other tasks
  - Dimensionality reduction
    - TF-IDF vs. topic mixing proportion
    - Classification, clustering, and more ...

## A Hierarchical Phrase-Based Model for Statistical Machine Translation

We present a statistical phrase-based Translation model that uses *hierarchical phrases*—phrases that contain sub-phrases. The model is formally a synchronous context-free grammar but is learned from a bitext without any syntactic information. Thus it can be seen as a shift to the *formal* machinery of syntax based translation systems without any *linguistic* commitment. In our experiments using BLEU as a metric, the hierarchical Phrase based model achieves a relative Improvement of 7.5% over Pharaoh, a state-of-the-art phrase-based system.



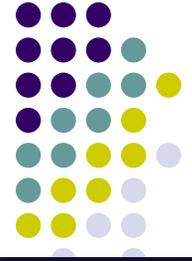

# Topic Models: The Big Picture

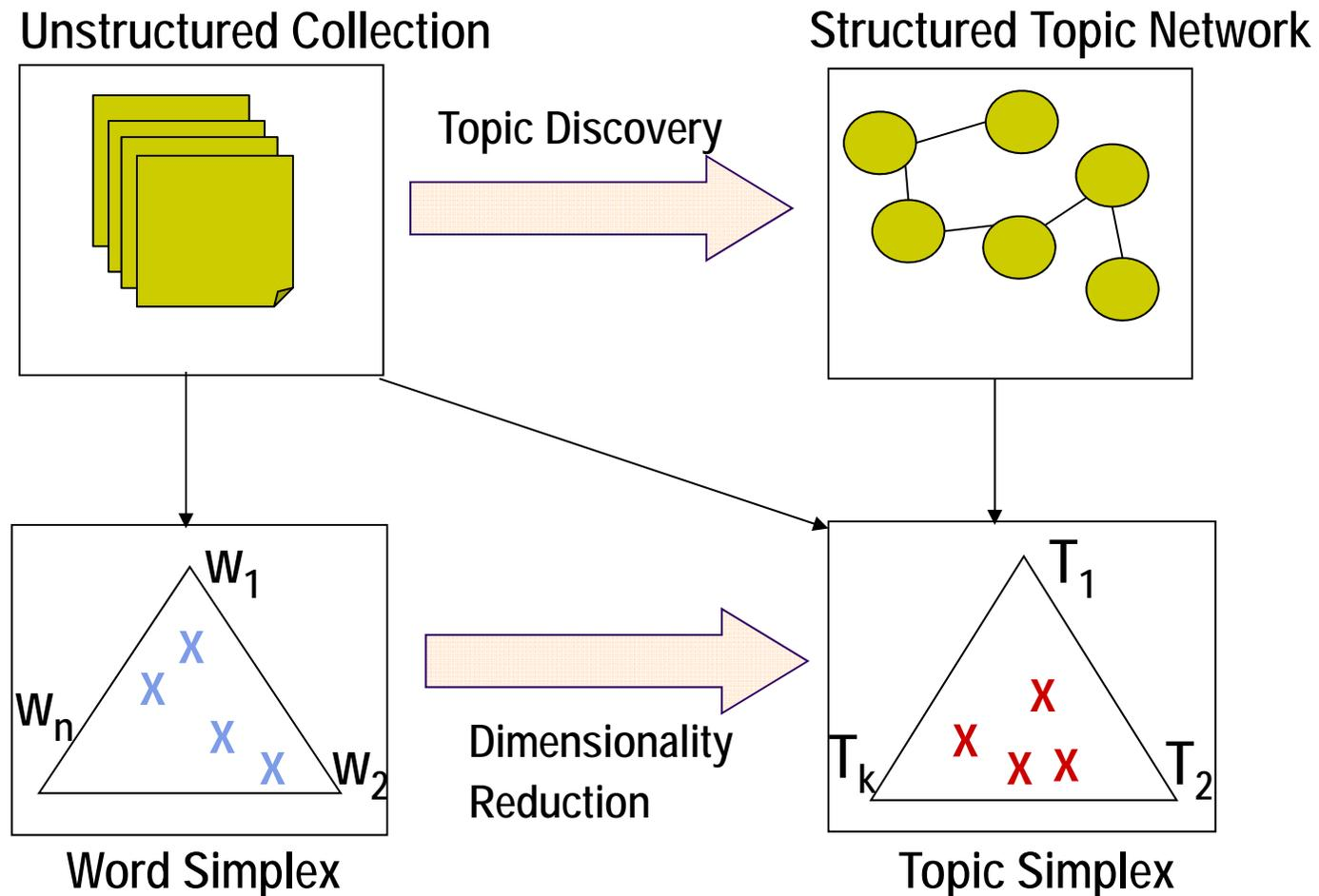

# LSI versus Topic Model (probabilistic LSI)

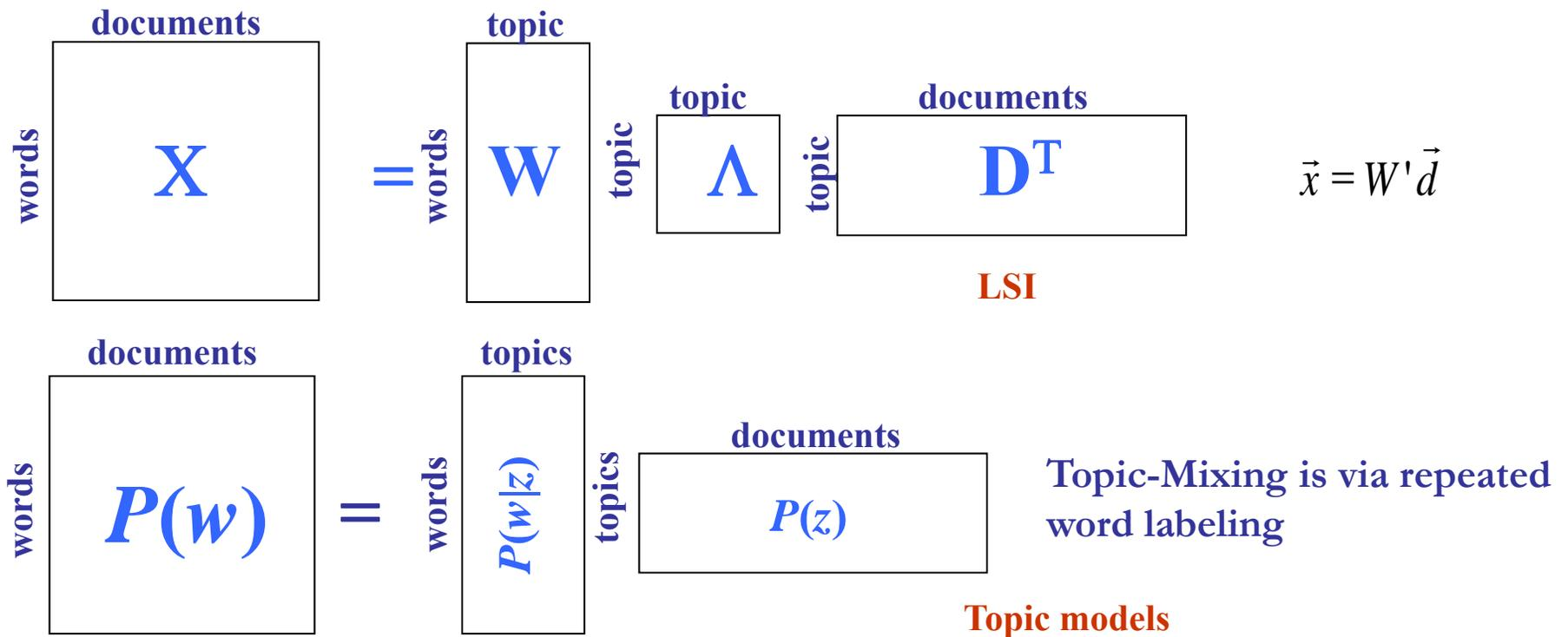

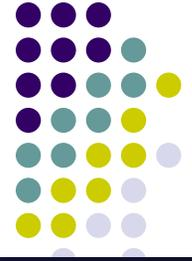

# Words in Contexts

- “It was a nice **shot.**”





# Words in Contexts (con'd)

- the opposition Labor **Party** fared even worse, with a predicted 35 **seats**, seven less than last **election**.

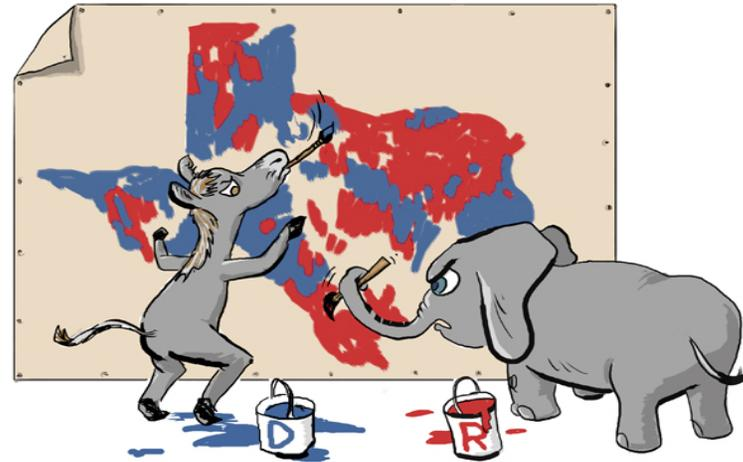



# "Words" in Contexts (con'd)

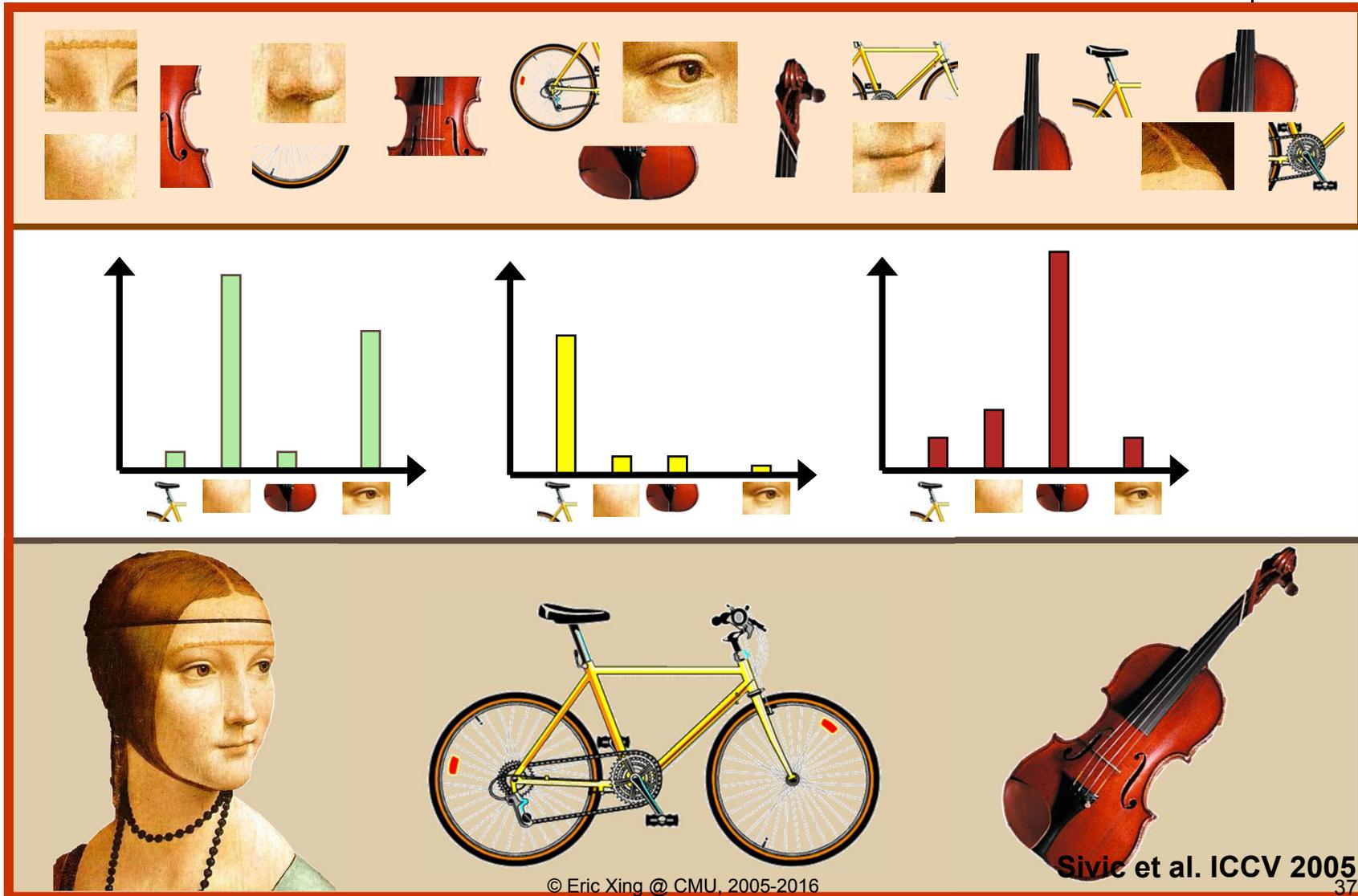

# Admixture Models



- Objects are **bags** of elements
- Mixtures are **distributions** over elements
- Objects have **mixing vector**  $\theta$ 
  - Represents each mixtures' contributions
- Object is **generated** as follows:
  - Pick a mixture component from  $\theta$
  - Pick an element from that component

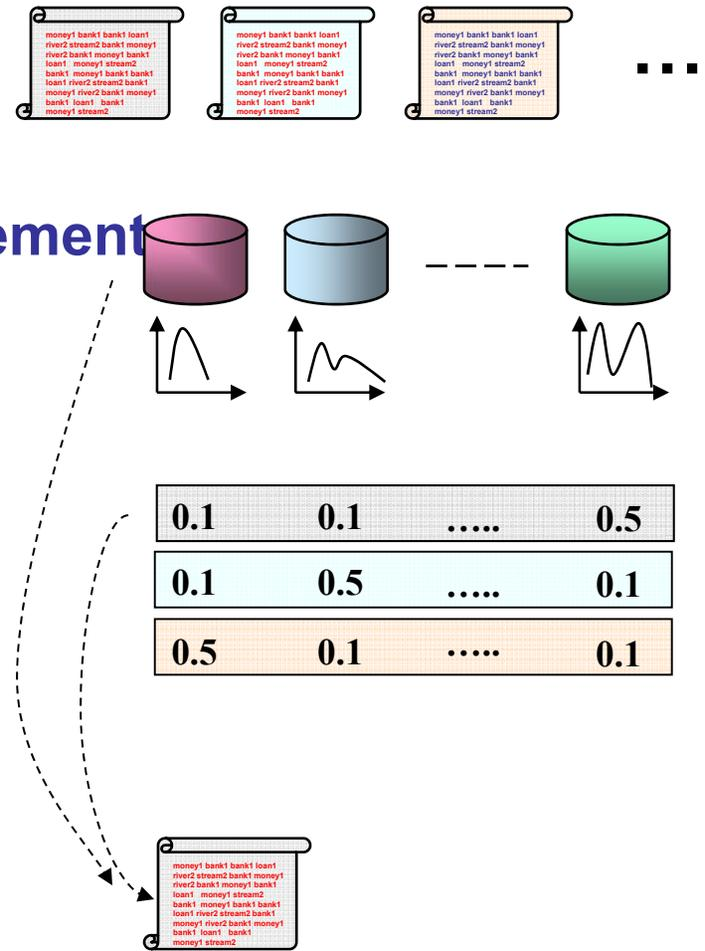

# Topic Models



## Generating a document

- Draw  $\theta$  from the prior
- For each word  $n$
- Draw  $z_n$  from *multinomial*  $l(\theta)$
  - Draw  $w_n | z_n, \{\beta_{1:k}\}$  from *multinomial*  $l(\beta_{z_n})$

Which prior to use?

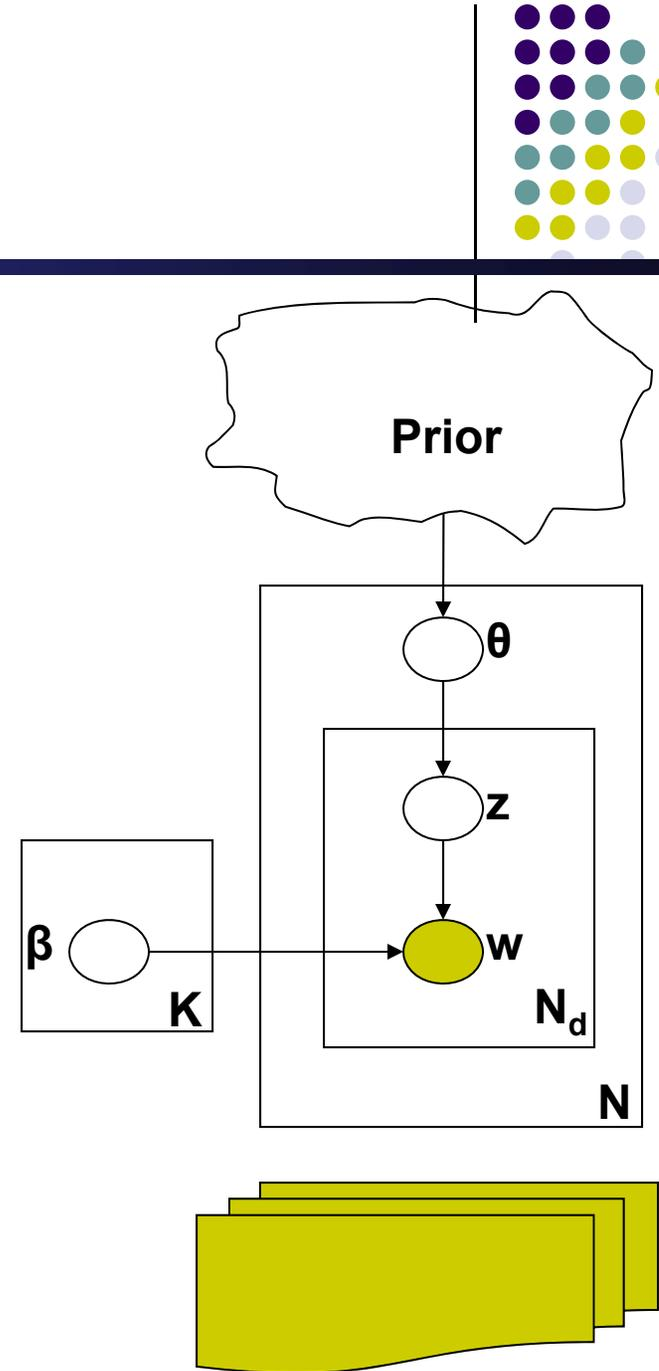



# Choices of Priors

- Dirichlet (LDA) (Blei et al. 2003)

- Conjugate prior means efficient inference
- Can **only** capture variations in each topic's intensity **independently**

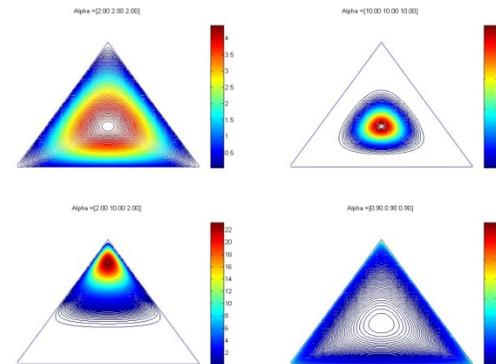

- Logistic Normal (CTM=LoNTAM) (Blei & Lafferty 2005, Ahmed & Xing 2006)

- Capture the intuition that some topics are highly correlated and can rise up in intensity together
- **Not** a conjugate prior implies **hard** inference

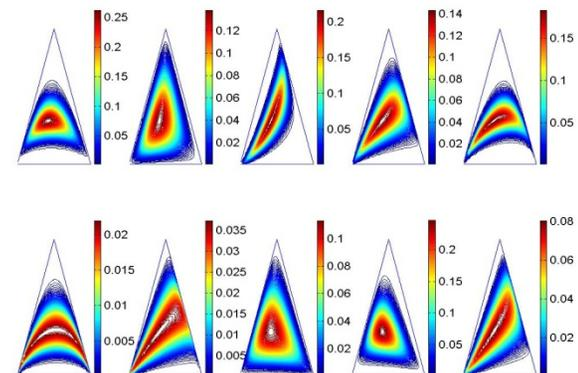



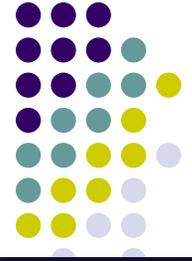

# Generative Semantic of LoNTAM

## Generating a document

- Draw  $\theta$  from the prior
- For each word  $n$
- Draw  $z_n$  from *multinomia*  $l(\theta)$
  - Draw  $w_n | z_n, \{\beta_{1:k}\}$  from *multinomia*  $l(\beta_{z_n})$

$$\theta \sim LN_K(\mu, \Sigma)$$
$$\gamma \sim N_{K-1}(\mu, \Sigma) \quad \gamma_K = 0$$
$$\theta_i = \exp \left\{ \gamma_i - \log \left( \mathbf{1} + \sum_{i=1}^{K-1} e^{\gamma_i} \right) \right\}$$
$$C(\gamma) = \log \left( \mathbf{1} + \sum_{i=1}^{K-1} e^{\gamma_i} \right)$$

- Log Partition Function  
- Normalization Constant

**Problem**

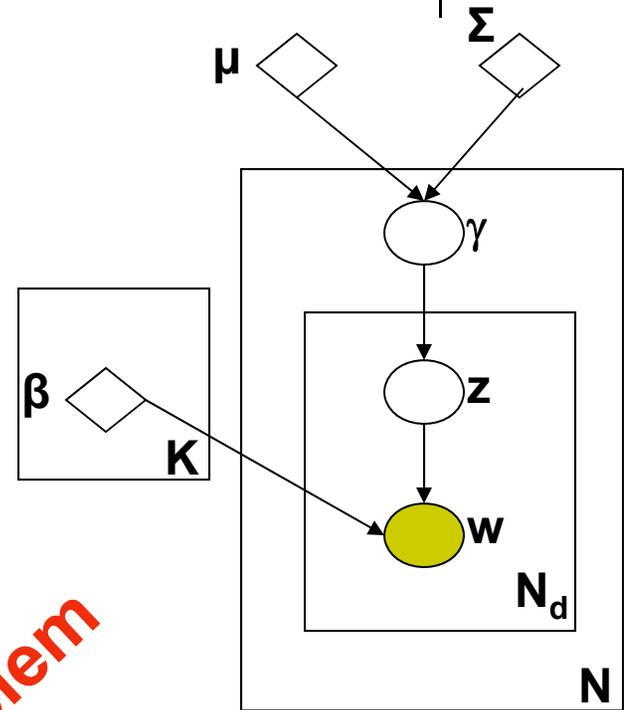

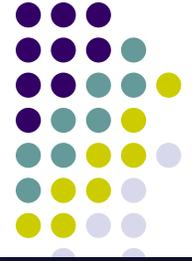

# Posterior inference

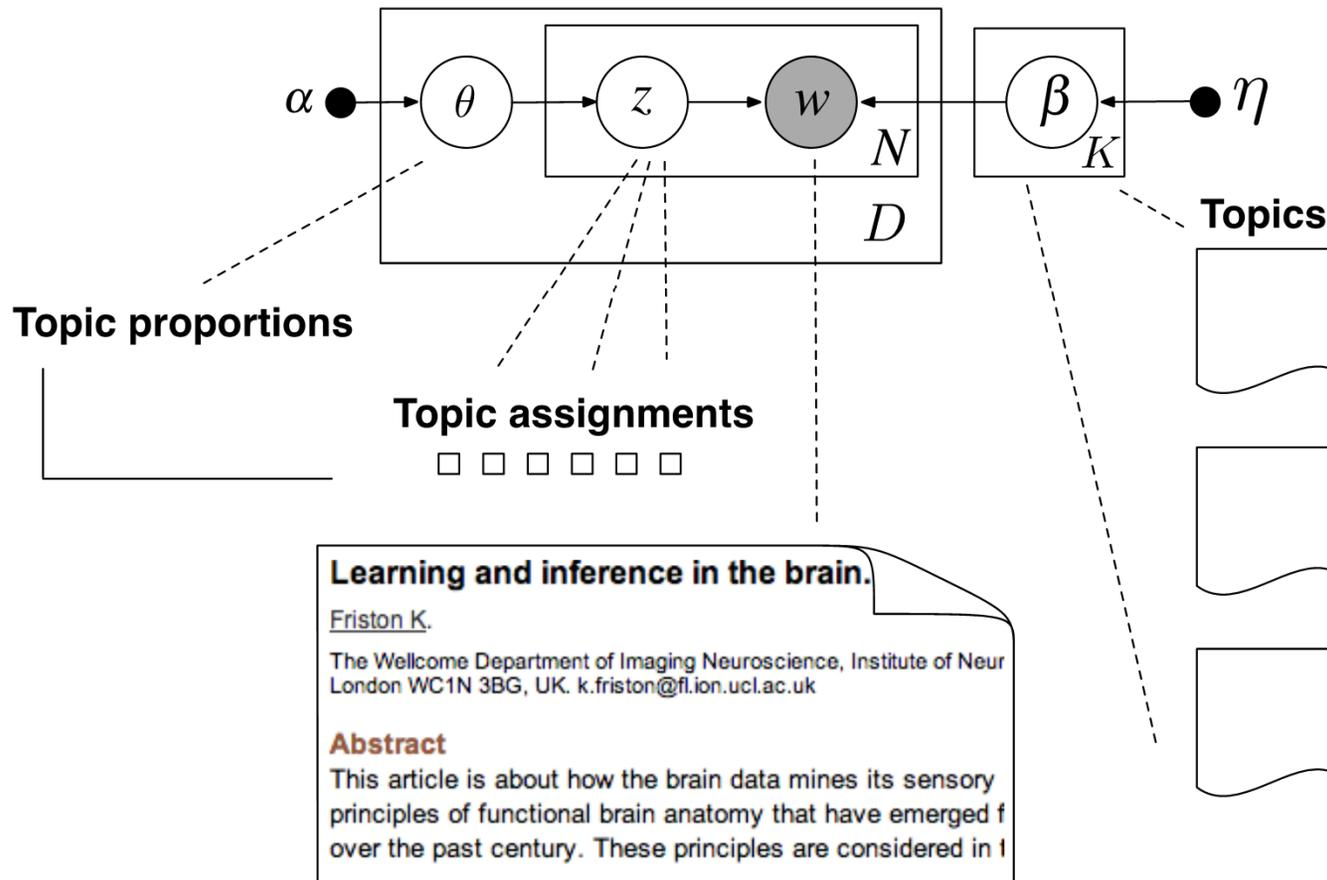

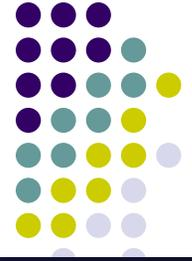

# Posterior inference results

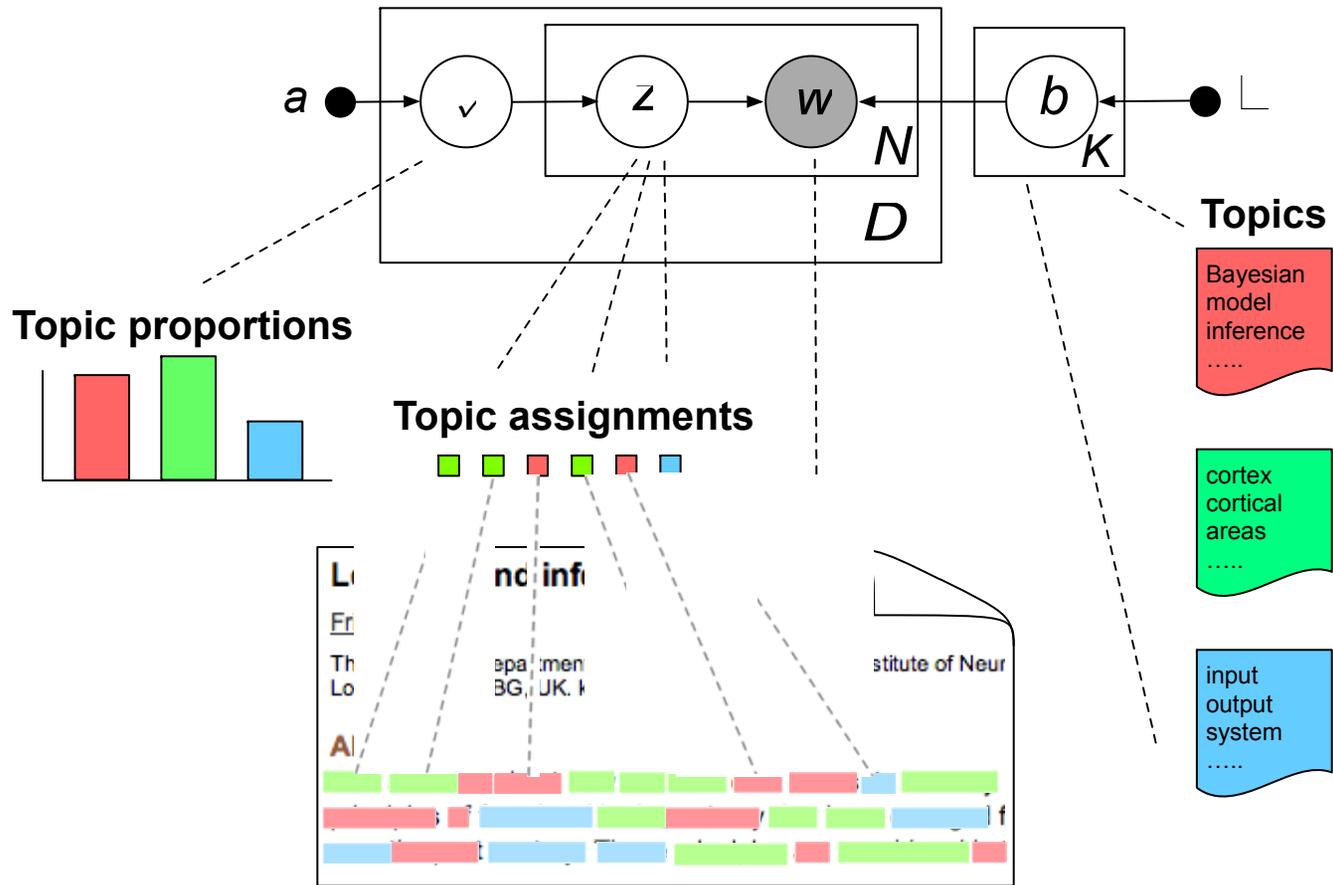

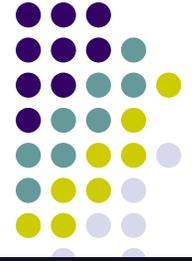

# Joint likelihood of all variables

$$p(\beta, \theta, z, w) = \prod_{k=1}^K p(\beta_k | \eta) \prod_{d=1}^D p(\theta_d | \alpha) \prod_{n=1}^N p(z_{dn} | \theta_d) p(w_{dn} | z_{dn}, \beta)$$

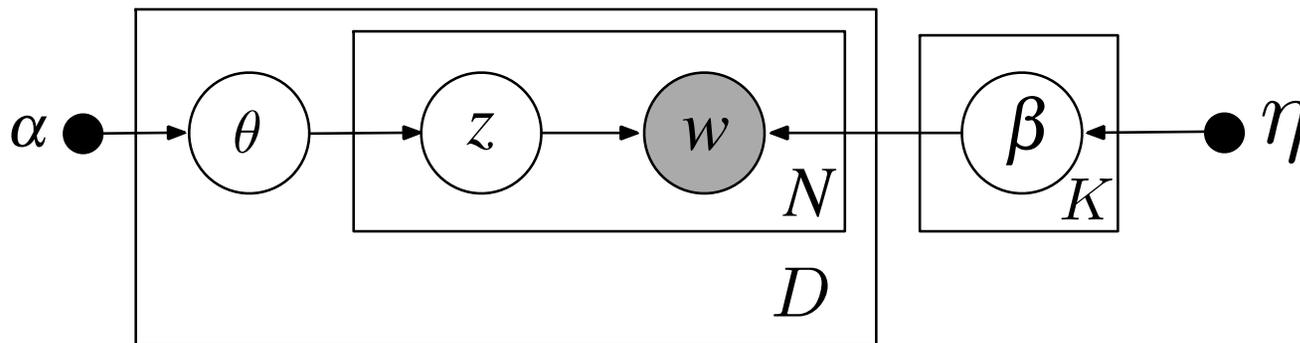

**We are interested in computing the posterior, and the data likelihood!**

# Inference and Learning are both intractable



- A possible query:

$$p(\theta_n | D) = ?$$

$$p(z_{n,m} | D) = ?$$

- Close form solution? 
$$p(\theta_n | D) = \frac{p(\theta_n, D)}{p(D)}$$
$$= \frac{\sum_{\{z_{n,m}\}} \int \left( \prod_n \left( \prod_m p(w_{n,m} | \beta_{z_n}) p(z_{n,m} | \theta_n) \right) p(\theta_n | \alpha) \right) p(\beta | \eta) d\theta_{-i} d\beta}{p(D)}$$

$$p(D) = \sum_{\{z_{n,m}\}} \int \cdots \int \left( \prod_n \left( \prod_m p(x_{n,m} | \beta_{z_n}) p(z_{n,m} | \theta_n) \right) p(\theta_n | \alpha) \right) p(\beta | \eta) d\theta_1 \cdots d\theta_N d\beta$$

- Sum in the denominator over  $T^n$  terms, and integrate over n  $k$ -dimensional topic vectors
- Learning: What to learn? What is the objective function?



# Approximate Inference

---

- Variational Inference
  - Mean field approximation (Blei et al)
  - Expectation propagation (Minka et al)
  - Variational 2<sup>nd</sup>-order Taylor approximation (Xing)
  
- Markov Chain Monte Carlo
  - Gibbs sampling (Griffiths et al)

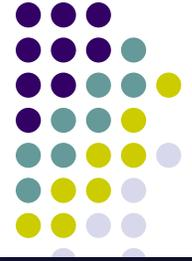

# Mean-field assumption

---

- True posterior

$$p(\beta, \theta, \mathbf{z} | \mathbf{w}) = \frac{p(\beta, \theta, \mathbf{z}, \mathbf{w})}{p(\mathbf{w})}$$

- Break the dependency using the fully factorized distribution

$$q(\beta, \theta, \mathbf{z}) = \prod_k q(\beta_k) \prod_d q(\theta_d) \prod_n q(z_{dn})$$

- Mean-field family usually does NOT include the true posterior.



# Update each marginals

- Update

$$q(\theta_d) \propto \exp \left\{ \mathbb{E}_{\prod_n q(z_{dn})} \left[ \log p(\theta_d | \alpha) + \sum_n \log p(z_{dn} | \theta_d) \right] \right\}$$

- In LDA,  
 $p(\theta_d | \alpha) \propto \exp \left\{ \sum_{k=1}^K (\alpha_k - 1) \log \theta_{dk} \right\}$  --- Dirichlet

$$p(z_{dn} | \theta_d) = \exp \left\{ \sum_{k=1}^K 1[z_{dn} = k] \log \theta_{dk} \right\}$$
 --- Multinomial

- We obtain

$$q(\theta_d) \propto \exp \left\{ \sum_{k=1}^K \left( \sum_{n=1}^N q(z_{dn} = k) + \alpha_k - 1 \right) \log \theta_{dk} \right\}$$

**This is also a Dirichlet---the same as its prior!**



# Coordinate ascent algorithm for LDA



- 1: Initialize variational topics  $q(\beta_k)$ ,  $k = 1, \dots, K$ .
- 2: **repeat**
- 3:     **for** each document  $d \in \{1, 2, \dots, D\}$  **do**
- 4:         Initialize variational topic assignments  $q(z_{dn})$ ,  $n = 1, \dots, N$
- 5:         **repeat**
- 6:             Update variational topic proportions  $q(\theta_d)$
- 7:             Update variational topic assignments  $q(z_{dn})$ ,  $n = 1, \dots, N$
- 8:             **until** Change of  $q(\theta_d)$  is small enough
- 9:         **end for**
- 0:     Update variational topics  $q(\beta_k)$ ,  $k = 1, \dots, K$ .
- 1: **until** Lower bound  $L(q)$  converges

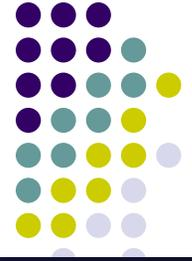

# Choice of $q()$ does matter

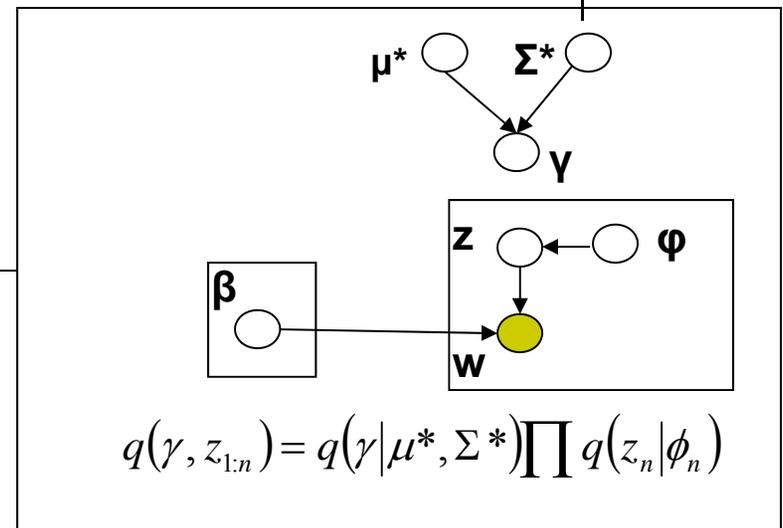
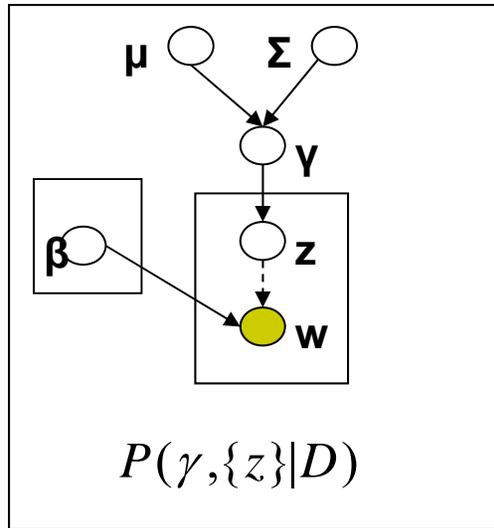

$\Sigma^*$  is full matrix

$\Sigma^*$  is assumed to be diagonal

**Multivariate Quadratic Approx.**

**Log Partition Function**

**Tangent Approx.**

Closed Form Solution for  $\mu^*, \Sigma^*$

$$\log \left( 1 + \sum_{i=1}^{K-1} e^{\gamma_i} \right)$$

Numerical Optimization to fit  $\mu^*, \text{Diag}(\Sigma^*)$

**Ahmed&Xing**

**Blei&Lafferty**

# Tangent Approximation

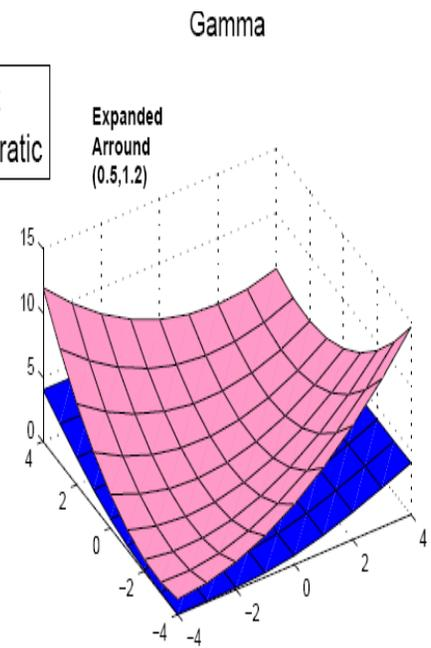
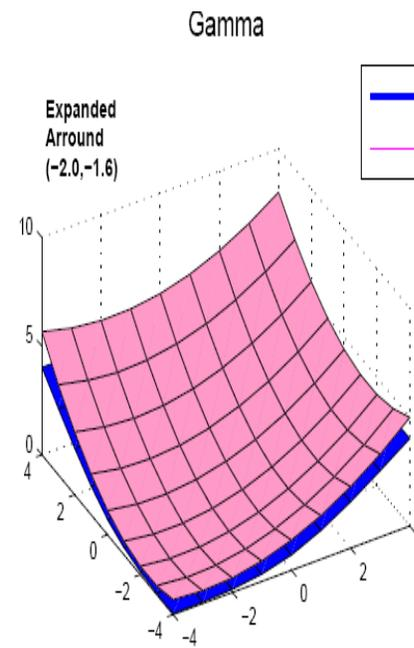
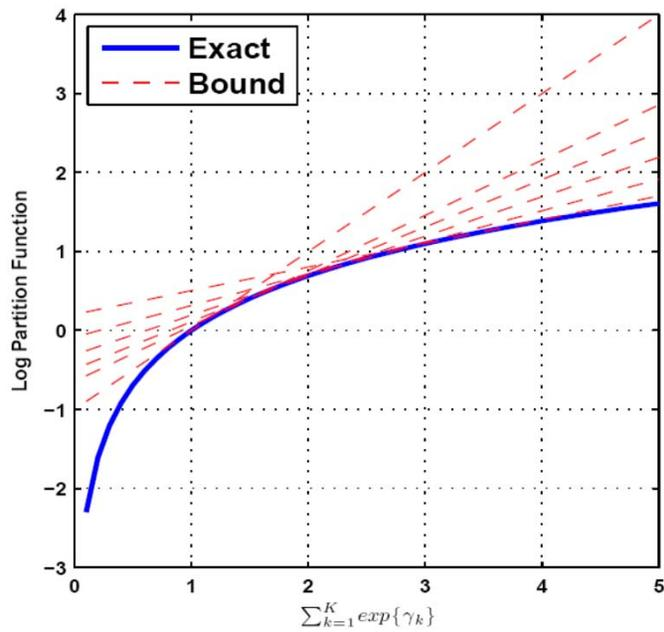

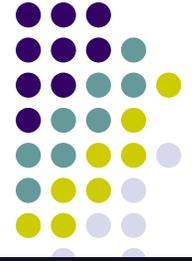

# How to evaluate?

- Empirical Visualization: e.g., topic discovery on New York Times

The 5 most frequent topics from the HDP on the *New York Times*.

game	life	film	book	wine
season	know	movie	life	street
team	school	show	books	hotel
coach	street	life	novel	house
play	man	television	story	room
points	family	films	man	night
games	says	director	author	place
giants	house	man	house	restaurant
second	children	story	war	park
players	night	says	children	garden

# How to evaluate?

- Test on Synthetic Text where ground truth is known:

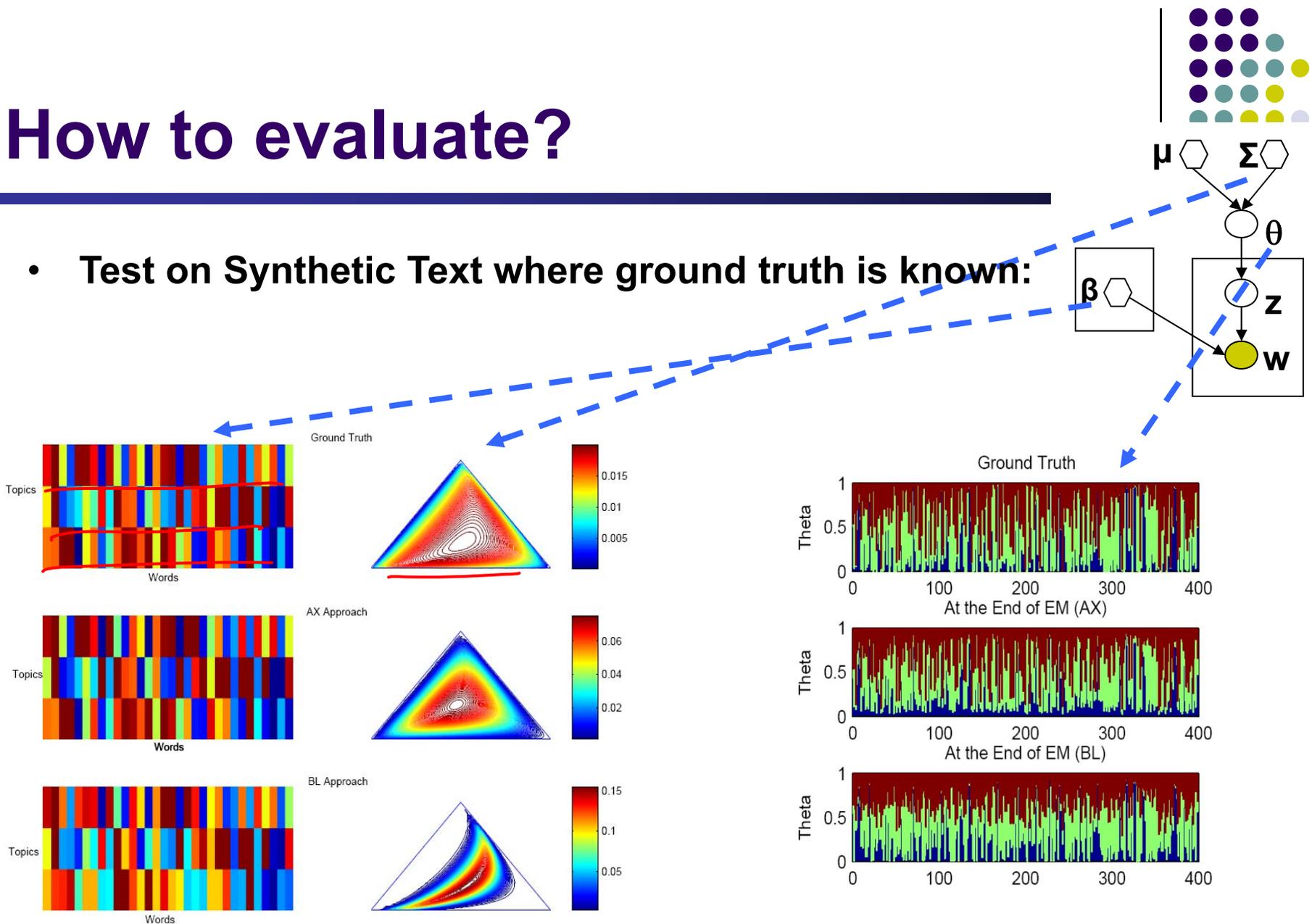



# Comparison: accuracy and speed

L2 error in topic vector est.  
and # of iterations

- Varying Num. of Topics

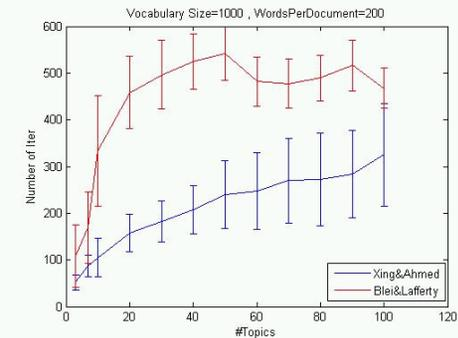
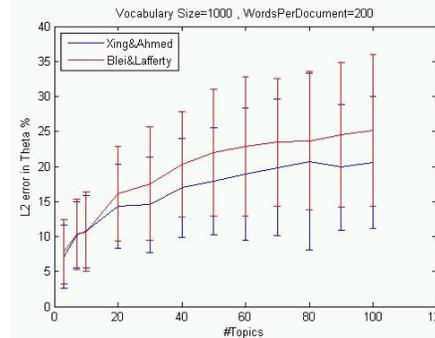

- Varying Voc. Size

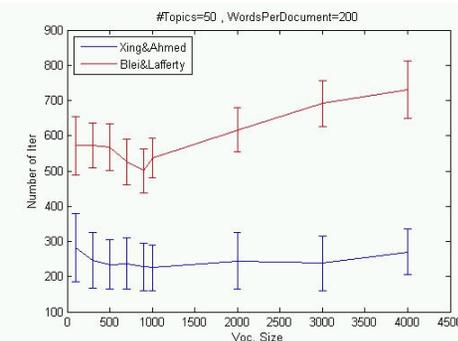
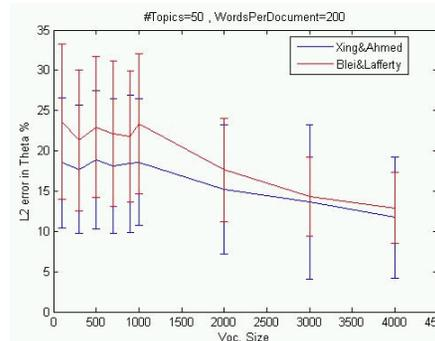

- Varying Num. Words Per Document

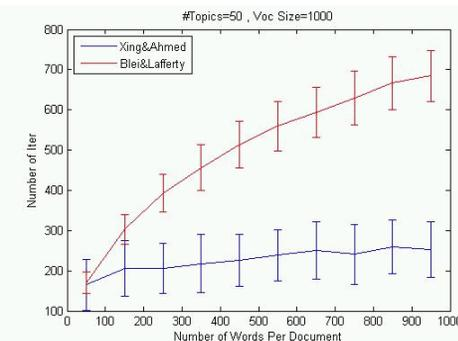
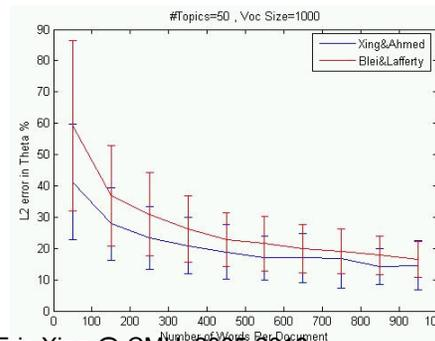



# Comparison: perplexity

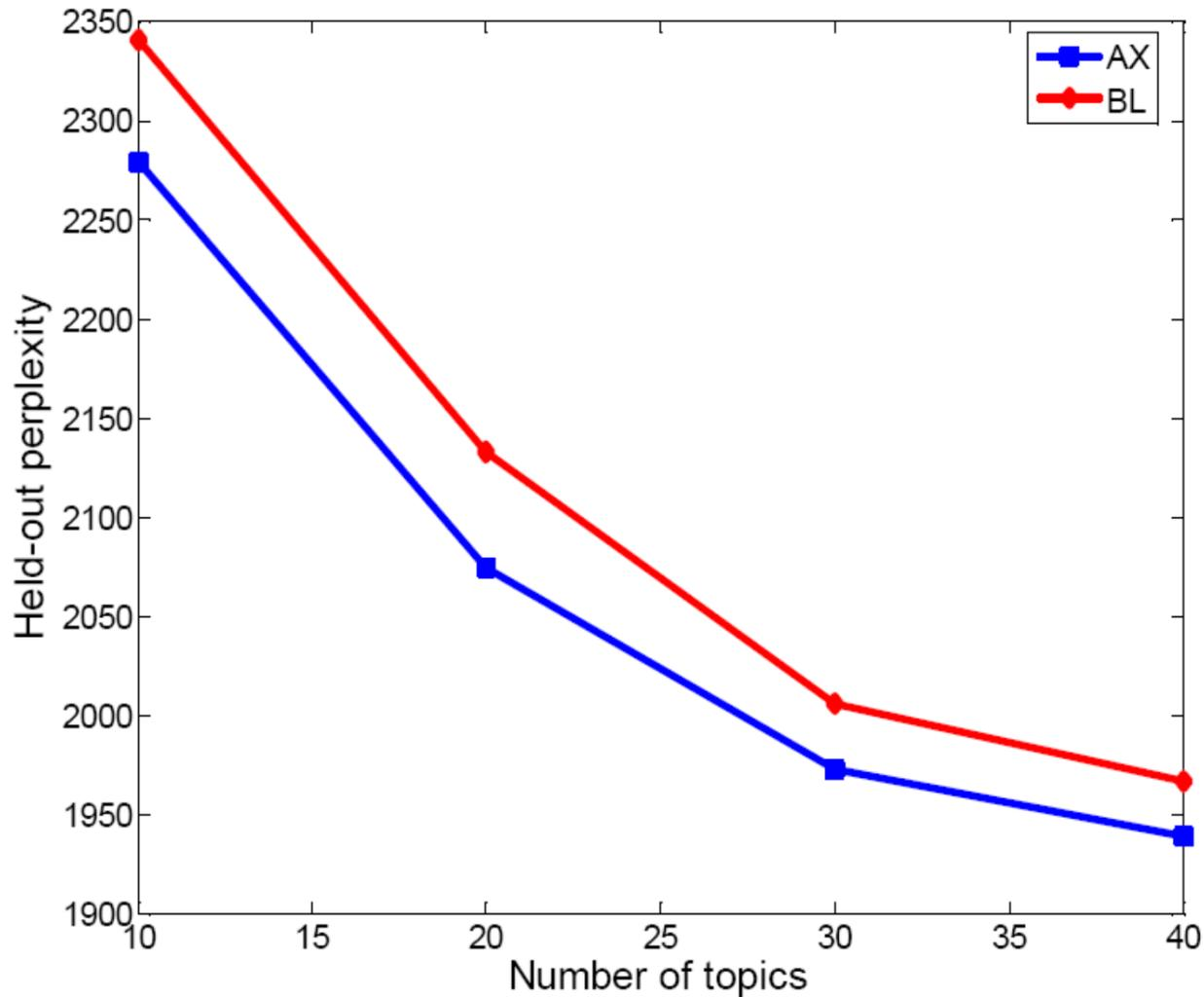

# Classification Result on PNAS collection



- PNAS abstracts from 1997-2002
  - 2500 documents
  - Average of 170 words per document
- Fitted 40-topics model using both approaches
- Use low dimensional representation to predict the abstract category
  - Use SVM classifier
  - 85% for training and 15% for testing

## Classification Accuracy

Category	Doc	BL	AX
Genetics	21	61.9	61.9
Biochemistry	86	65.1	77.9
Immunology	24	70.8	66.6
Biophysics	15	53.3	66.6
Total	146	64.3	72.6

-Notable Difference  
-Examine the low dimensional representations below



# What makes topic models useful - -- The Zoo of Topic Models!



- It is a building block of many models.

Williamson et al. 2010

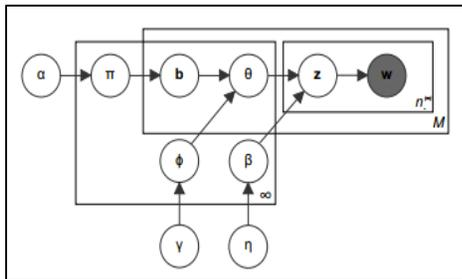

Chang & Blei, 2009

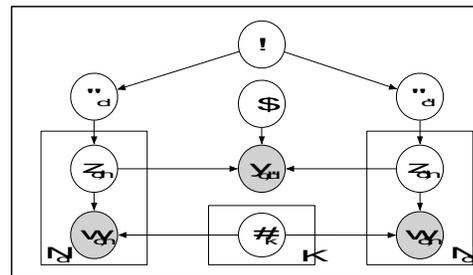

Titov & McDonald, 2008

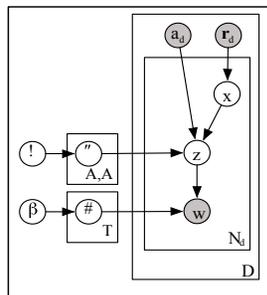
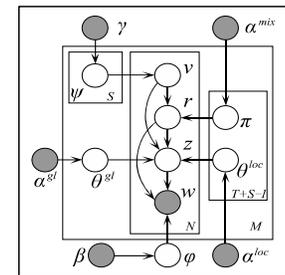

McCallum et al. 2007

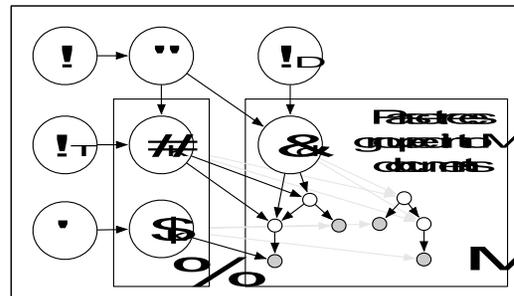

Boyd-Graber & Blei, 2008

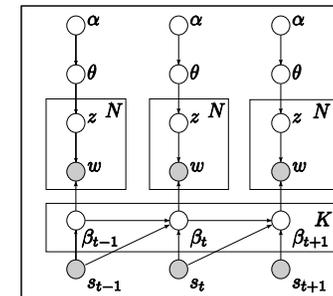

Wang & Blei, 2008



# Conclusion

---

- GM-based topic models are cool
  - Flexible
  - Modular
  - Interactive
- There are many ways of implementing topic models
  - unsupervised
  - supervised
- Efficient Inference/learning algorithms
  - GMF, with Laplace approx. for non-conjugate dist.
  - MCMC
- Many applications
  - ...
  - Word-sense disambiguation
  - Image understanding
  - Network inference



# Summary on VI

---

- Variational methods in general turn inference into an optimization problem via **exponential families** and **convex duality**
- The exact variational principle is intractable to solve; there are two distinct components for approximations:
  - Either **inner** or **outer** bound to the marginal polytope
  - Various approximation to the entropy function
- Mean field: **non-convex inner bound** and **exact form of entropy**
- BP: **polyhedral outer bound** and **non-convex Bethe approximation**
- Kikuchi and variants: tighter polyhedral outer bounds and better entropy approximations (Yedidia et. al. 2002)