

What You Need to Know for Project Three

Dave Eckhardt
Steve Muckle

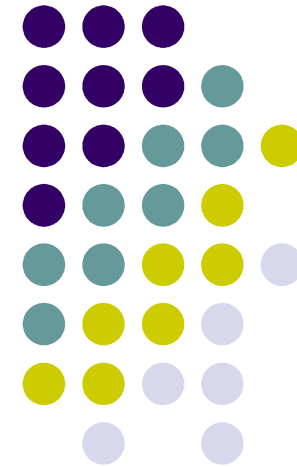

Synchronization



Introduction to the Kernel Project

- Project 3 Checkpoint 1
 - Wednesday Mar. 2nd class-period demo: 5207 cluster

Upcoming dates

- Mid-term examination Monday Feb. 28th
 - Expect mail from Bruce today
 - If you have a conflict, let us know *today*
- Homework 1 will be between now & then (for you!)

Final Exam list will be posted soon

- You must notify us of conflicts in a timely fashion

Synchronization



- Reminder: Book report
 - Please don't complain end-of-semester due date!
- Thinking about the future
 - Summer internship with SCS Facilities?
 - 15-412, OS Practicum
 - 15-???, Secret Mystery Class

Overview



Introduction to the Kernel Project

Mundane Details in x86

registers, paging, the life of a memory access, context switching, system calls, kernel stacks

Loading Executables

Style Recommendations (or pleas)

Attack Strategy

A Quick Debug Story

Introduction to the Kernel Project



P3:P2 :: P2:P1!

P2

- Stack, registers, stack, race conditions, stack

P3

- Stack, registers, page tables, scheduling, races...

You will “become one with” program execution

P1: living without common assumptions

P3: providing those assumptions to users

The P3 Experience



- Goals/challenges
 - More understanding
 - Of OS
 - Practice with synthesizing design requirements
 - More code
 - More planning
 - More organization
 - More quality!
 - Robust
 - ***More debugging!***

Introduction to the Kernel Project: Kernel Features



Your kernels will feature:

- preemptive multitasking
- multiple virtual address spaces
- a “small” selection of useful system calls
- robustness (hopefully)

Introduction to the Kernel Project: Preemptive Multitasking



Preemptive multitasking is
forcing multiple user
processes to share the CPU

You will use the timer interrupt
to do this

Reuse your timer code from P1
if possible



Introduction to the Kernel Project: Preemptive Multitasking



Simple round-robin scheduling will suffice

- Some system calls will modify the sequence
- Think about them before committing to a design

Context switching is tricky but cool

As in P2, creating a new task/thread is hard

- Especially given memory sharing

As in P2, exit is tricky too

- At least one “How can I do that???” question

Introduction to the Kernel Project: Multiple Virtual Address Spaces



The x86 architecture supports paging

You will use this to provide a virtual address space for each user task

Each user task will be isolated from others

Paging will also protect the kernel from users

Segmentation will not be used for protection

Introduction to the Kernel Project: System Calls



You used them in P2

Now you get to implement them

Examples include `fork()`, `exec()`, `thread_fork`

There are easier ones like `gettid()`

The core cluster – *must* work solidly

- `fork()`, `exec()`
- `exit()`, `wait()`

Mundane Details in x86



We looked at some of these for P1

Now it is time to get the rest of the story

How do we control processor features?

What does an x86 page table look like?

What route does a memory access take?

How do you switch from one process to another?

Mundane Details in x86: Registers



General purpose regs (not interesting)

Segment registers (somewhat interesting)

- %cs, %ss, %ds, %es, %fs, %gs

%eip (a little interesting)

EFLAGS (interesting)

Control Registers (very interesting)

- %cr0, %cr1, %cr2, %cr3, %cr4
- esp0 field in hardware task

Mundane Details in x86: General Purpose Registers



The most boring kind of register

`%eax`, `%ebx`, `%ecx`, `%edx`, `%edi`, `%esi`, `%ebp`,
`%esp`

`%eax`, `%ebp`, and `%esp` are exceptions, they
are slightly interesting

- `%eax` is used for return values
- `%esp` is the stack pointer
- `%ebp` is the base pointer

Mundane Details in x86: Segment Selector Registers



Slightly more interesting

%cs specifies the segment used to access code (also specifies privilege level)

%ss specifies the segment used for stack related operations (pushl, popl, etc)

%ds, %es, %fs, %gs specify segments used to access regular data

Mind these during context switches!!!

Mundane Details in x86: The Instruction Pointer (%eip)



It's interesting

Cannot be read from or written to directly

- (branch, call, return)

Controls which instructions get executed

'nuff said.

Mundane Details in x86: The EFLAGS Register



It's interesting

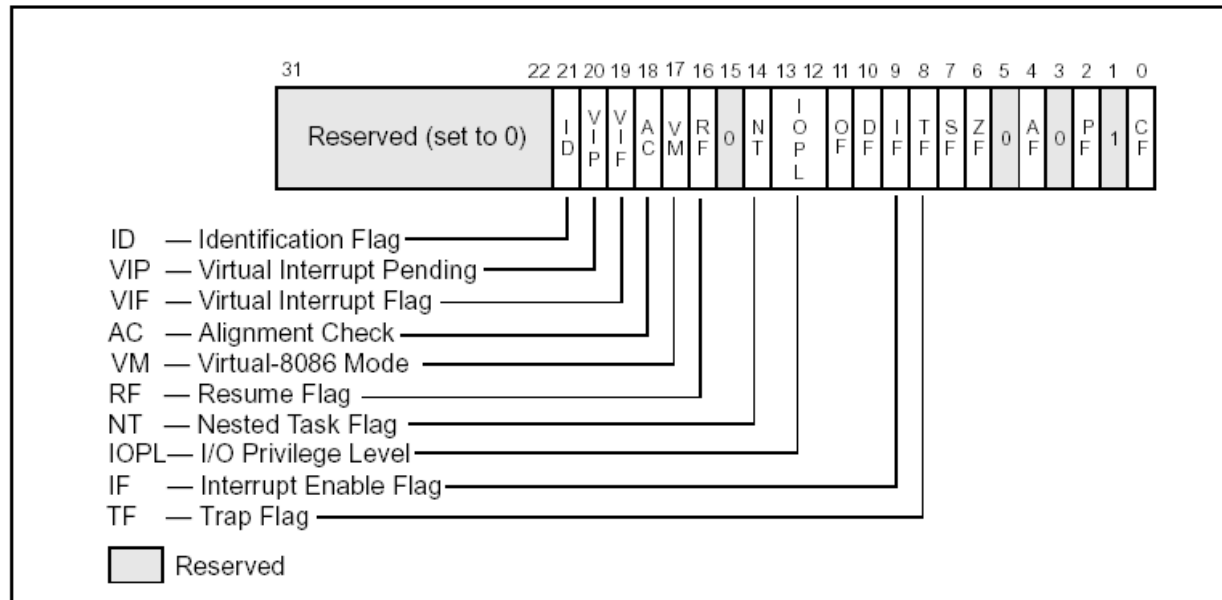

Figure 2-3. System Flags in the EFLAGS Register

Flag city, including interrupt-enable, arithmetic flags

- “Alignment check” off

Mundane Details in x86: Control Registers



Very interesting!

An assortment of important flags and values

`%cr0` contains powerful system flags that control things like paging, protected mode

`%cr1` is reserved (now that's really interesting)

`%cr2` contains the address that caused the last page fault

Mundane Details in x86: Control Registers, cont.



`%cr3` contains the address of the current page directory, as well as a couple paging related flags

`%cr4` contains... more flags (not as interesting though)

- protected mode virtual interrupts?
- virtual-8086 mode extensions?
- No thanks

Mundane Details in x86: Registers



How do you write to a special register?

Most of them: `movl` instruction

Some (like CRs) you need PL0 to access

We provide inline assembly wrappers

EFLAGS is a little different, but you will not be writing directly to it anyway

Mundane Details in x86: The Life of a Memory Access



Logical Address (consists of 16 bit segment selector, 32 bit offset)

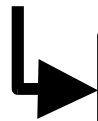

Linear Address (32 bit offset)

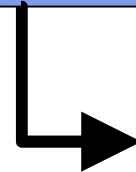

Physical Address
(32 bit offset)

Mundane Details in x86: The Life of a Memory Access



Logical Address (consists of 16 bit segment selector, 32 bit offset)



The 16 bit segment selector comes from a segment register (%CS & %SS implied)

The 32 bit offset is added to the base address of the segment

That gives us a 32 bit offset into the virtual address space

Mundane Details in x86: Segmentation



Segments need not be backed by physical memory and can overlap

Segments defined for these projects:

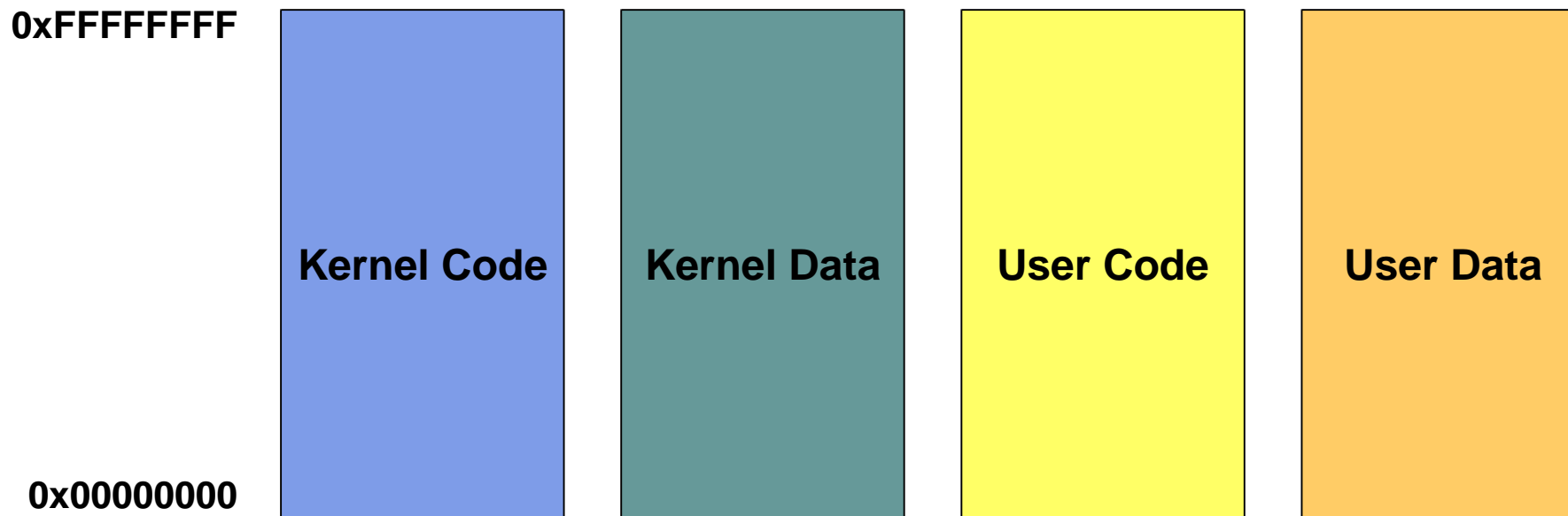

Mundane Details in x86: Segmentation



For Project 3 we are abusing segmentation

- All segments “look the same”
- Confusing, but simplifies life for you
- See 15-410 segmentation guide on web site

Mundane Details in x86: The Life of a Memory Access

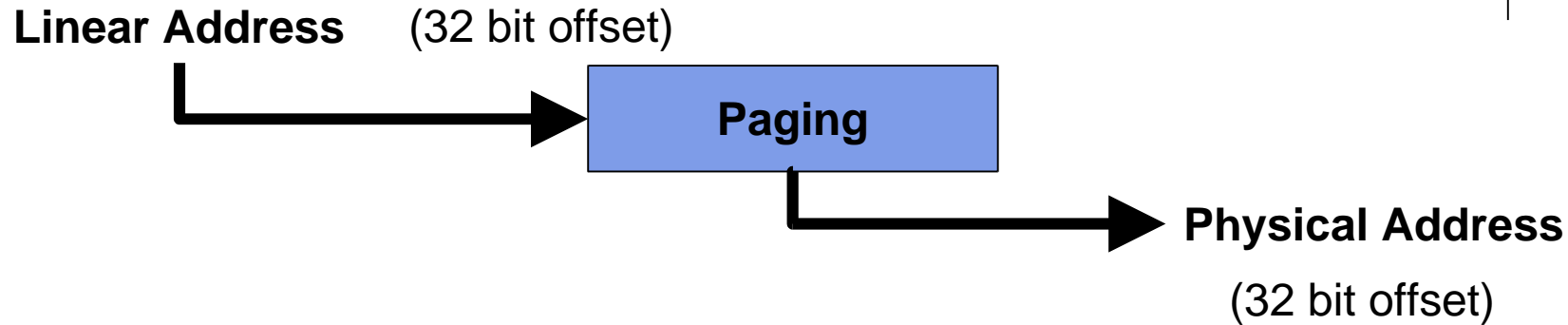

Top 10 bits index into page directory, point us to a page table

The next 10 bits index into page table, point us to a page

The last 12 bits are an offset into that page

Mundane Details in x86: Page Directories and Tables

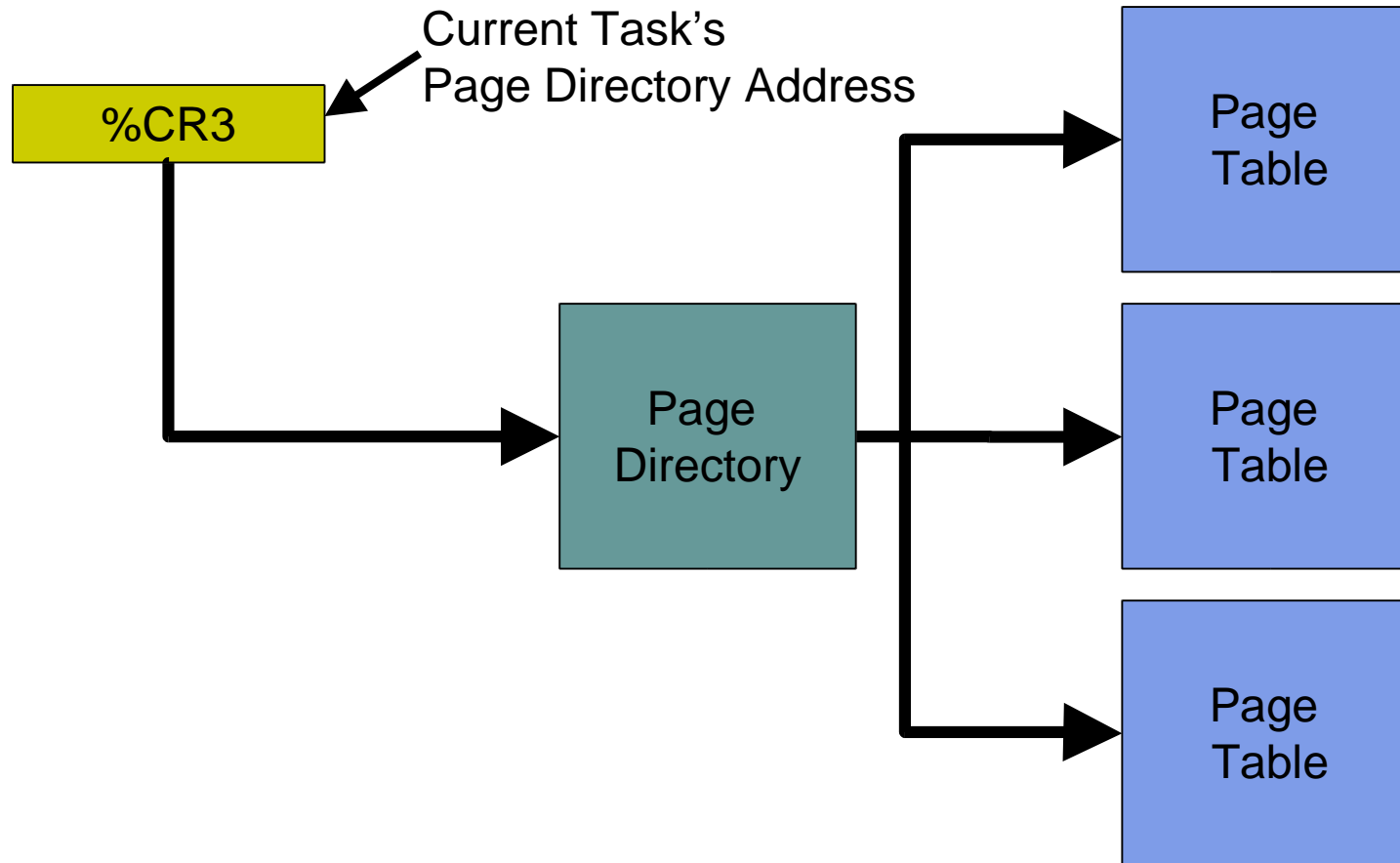

Mundane Details in x86: Page Directory



The page directory is 4k
in size

Contains
pointers
to page tables

Entries may be
invalid (see
“P” bit)

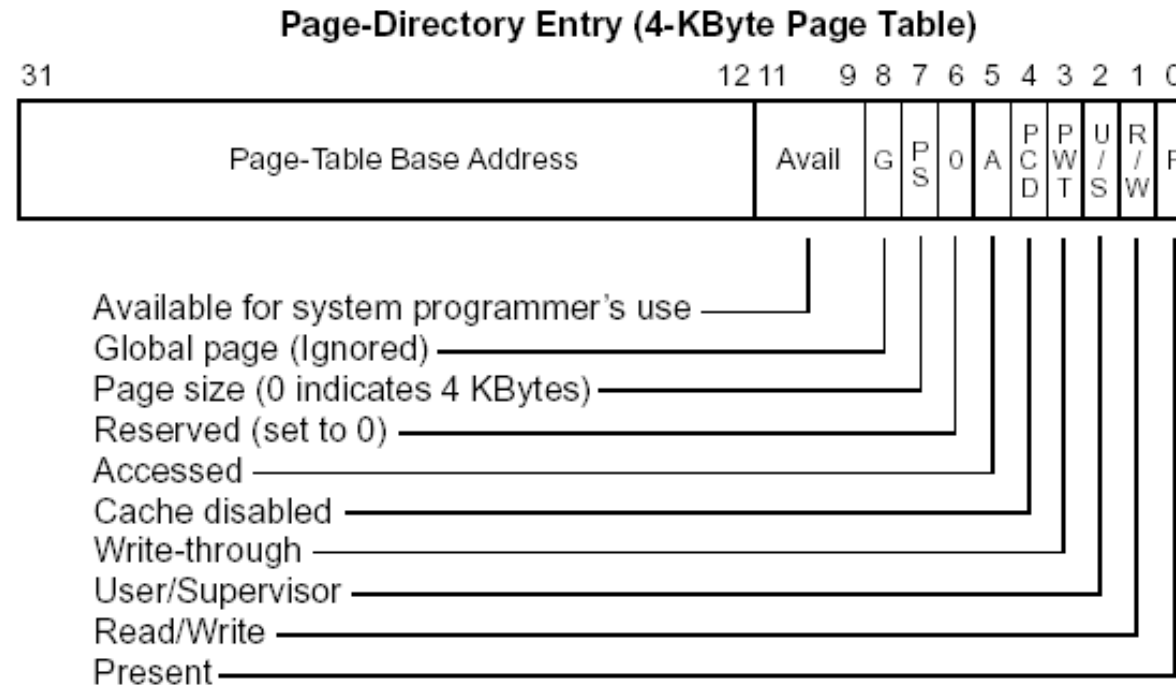

Figure from page 87 of intel-sys.pdf
This a jumping-off point!

Mundane Details in x86: Page Table



The page table is also 4k
in size

Contains
pointers
to pages

“P” bit again

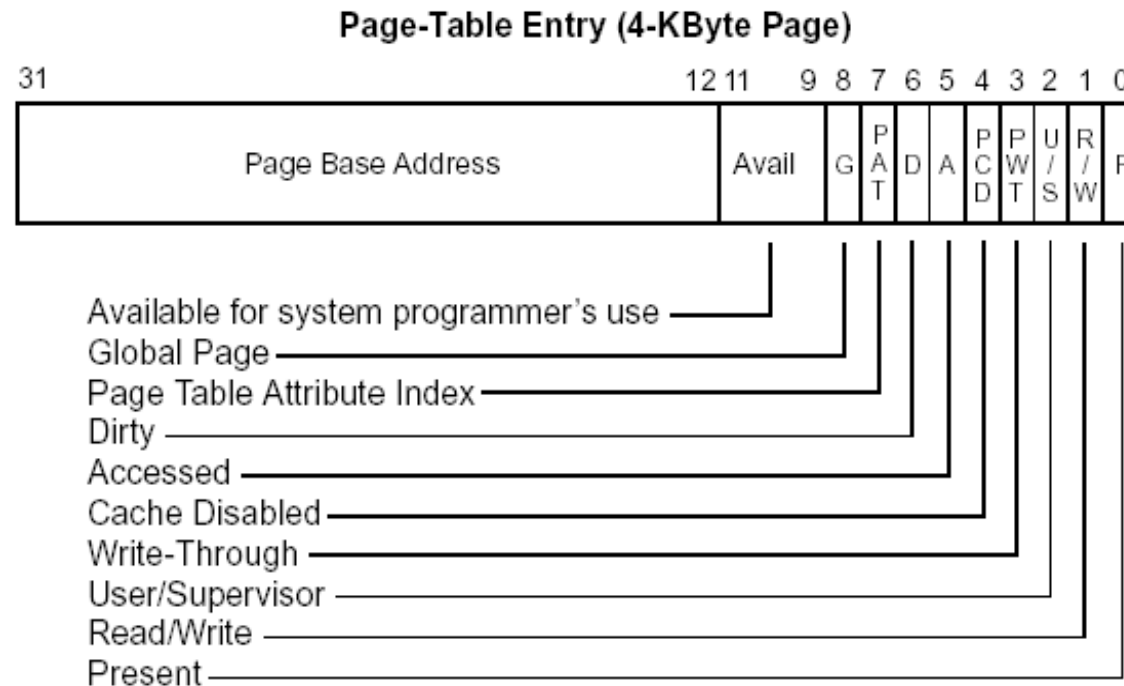

Figure from page 87 of intel-sys.pdf
This a jumping-off point!

Mundane Details in x86: The Life of a Memory Access



Whoa there, Slick... What if the page directory entry isn't there?

What happens if the page table entry isn't there?

It's called a page fault, it's an exception, and it lives in IDT entry 13

You will have to write a handler for this exception and do something intelligent

Mundane Details in x86: Context Switching



We all know that
processes take turns
running on the CPU

This means they have to
be stopped and started
over and over

How?

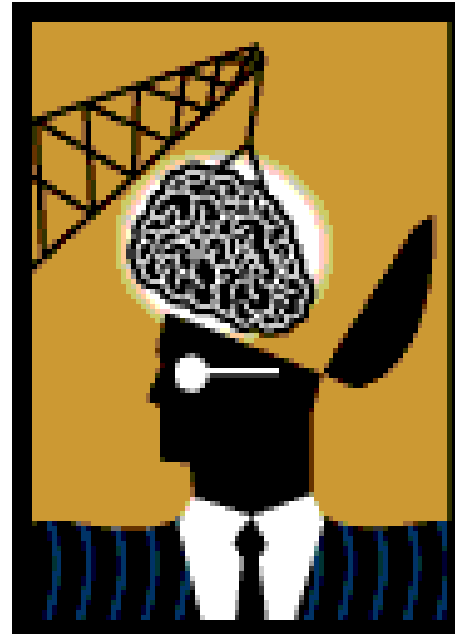

Mundane Details in x86: Context Switching



The x86 provides a hardware “task” abstraction

- This makes context switching easy

But...

- Often faster to manage processes in software
- We can also tailor our process abstraction to our particular needs
- Our OS is more portable if it doesn't rely on one processor's notion of “task”

Protected mode requires one hardware task

- Already set up by 410 boot code

Mundane Details in x86: Context Switching



Context switching is a very delicate procedure
Great care must be taken so that when the
thread is restarted, it does not know it ever
stopped

“User” registers must be exactly the same
(%cr3 is the only control register you have to
update)

Its stack must be exactly the same
Its page directory must be in place

Mundane Details in x86: Context Switching



Hints on context switching:

- Use the stack, it is a convenient place to store things
- If you do all your switching in one routine, you have eliminated one thing you have to save (%eip)
- New threads will require some special care
 - Try to confine this code; don't infect your beautiful pure context-switcher

Mundane Details in x86: System Calls



System calls use “software interrupts”

Install handlers just as you did for the timer,
keyboard

Calling convention specified in handout

- Matches P2

If you are rusty on the IDT refer back to P1

Mundane Details in x86: Kernel Stacks



User processes have a separate stack for their kernel activities

Located in kernel space

How does the stack pointer get switched to the kernel stack?

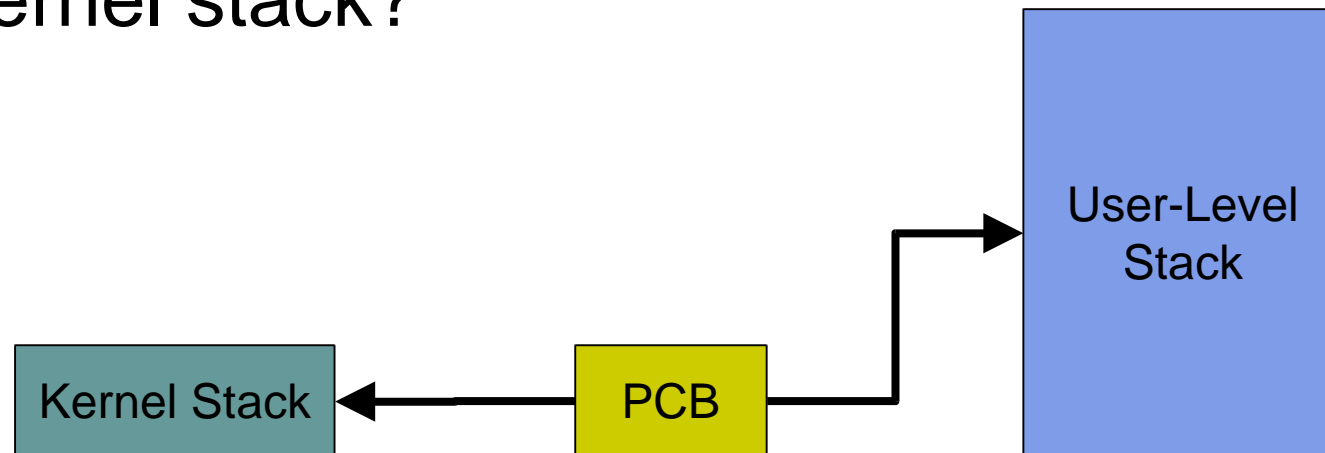

Mundane Details in x86: Kernel Stacks



When the CPU switches from user mode to kernel mode the stack pointer is changed

The new (kernel) stack pointer to use is stored in the configuration of the CPU hardware task

We provide a function to change this value

`set_esp0(void* ptr)`

Used during next user \Rightarrow kernel transition

- So `set_esp0()` “does nothing” (right away)

Loading Executables



Same approach as P2
“RAM disk” file system
But you must write a
loader

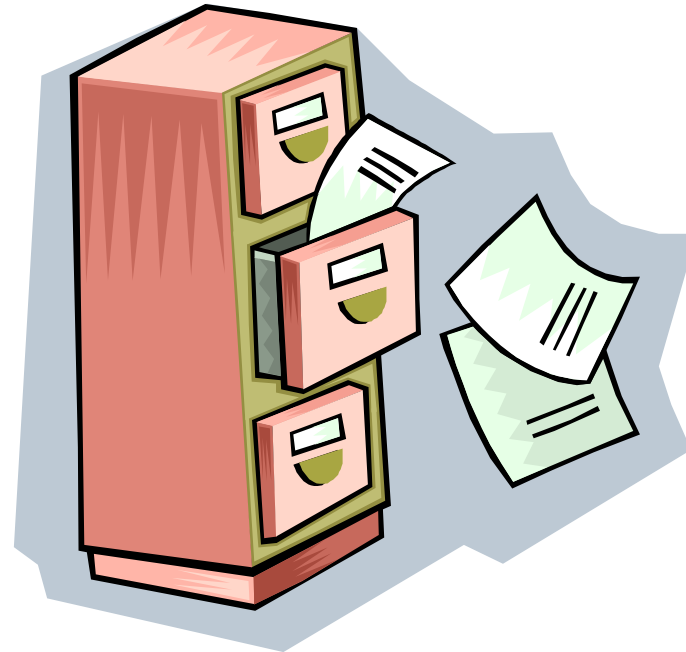

Loading Executables: The Loader



RAM-disk bytes are part of the kernel data area
You need to load them into the task's address
space

Code, rodata, data, bss, stack – all up to you!

Executables will be in “simple ELF” format

References to resources are in the handout

Encapsulation!!!!



You will re-implement chunks of your kernel

It will be painful if code is holographic

Don't “use a linked list of threads”

Do define a process-list interface

- find(), append(), first(), ...

You may need to add a method...

- ...which changes the implementation entirely...
- But most existing interface uses (calls) will be ok



Machine State Summary

256 MB RAM, keyboard, console, timer

IDT

CPU state

- General-purpose registers
- Segment registers
- EFLAGS, cr0...cr4, esp0

We set up for you

- Hardware task
- GDT (global descriptor table) – 4 segments

Attack Strategy



There is an attack strategy in the handout

It represents where we think you should be in particular weeks

You WILL have to turn in checkpoints

Excellent data indicate...

Missing one checkpoint is dangerous...don't miss two!



Attack Strategy



Please read the handout a couple times over the next few days

Create doxygen-only files

- scheduler.c, process.c, ...
- Document major functions
- Document key data structures
- A very iterative process

Suggestion: doxygen tentative responsibilities

- For a good time, estimate #lines, #days

Attack Strategy



Make an explicit partnership plan

- How often you'll meet, for how long
- Information flow
 - When will you read each other's code?
- Meeting suggestions
 - Last time's open issues
 - New issues
 - Who will do what by next meeting?

Grading Approach



These numbers are not final!

<i>Weight</i>	<i>Section</i>
50	Shell loads, runs test programs
10	Concurrency
10	Style/structure
10	Basic tests
15	Non-basic tests
5	Thread tests (not using your P2)



“Hurdle” Model

We will release a test suite

- ~15 “basic” tests
- ~15 “solidity” tests

Successful completion of Project 3 requires

- ~80% of each section of test suite
- Acceptable preemptibility

You will self-test your P3 when you turn it in



“Hurdle” Model

Leap the P3 hurdle?

- Work on Project 4
 - ~2 weeks after P3
 - ~5% of course grade
- A modification/extension of your kernel
 - Goal: “interesting”, more than “hard”

Thwarted?

- Extra time for P3 (~1 week)
- 0% will be assigned for P4 grade

A Quick Debug Story



Ha! You'll have to have
been to lecture to hear
this story.



A Quick Debug Story



The moral is, please start early.

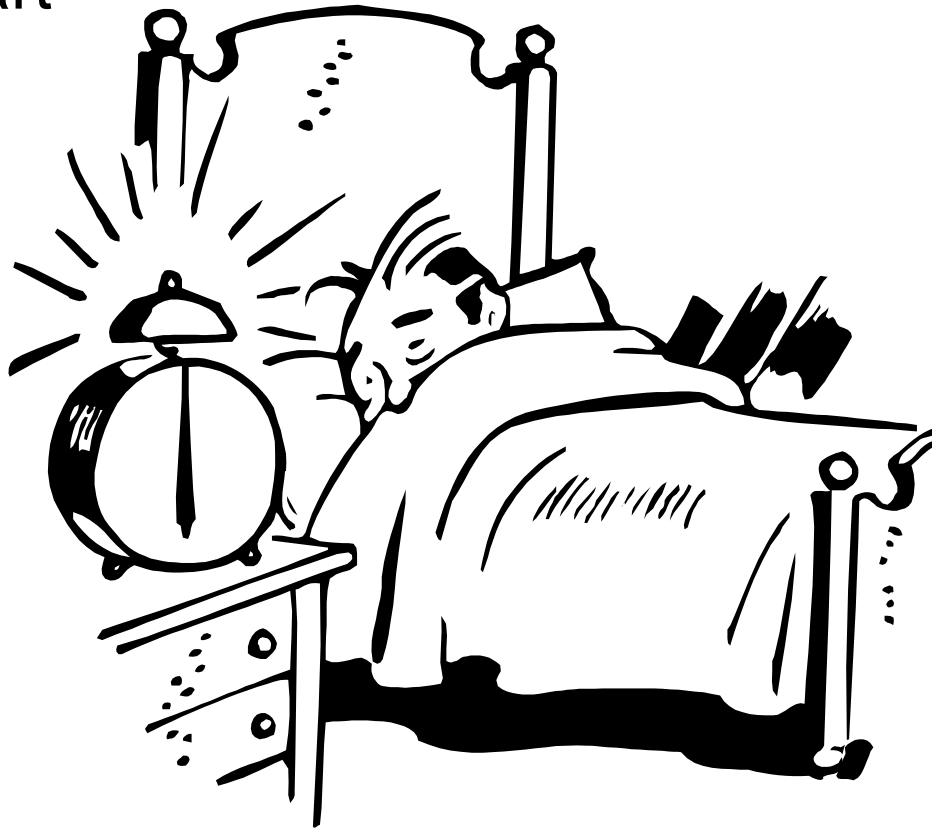

Our Hopes for You



Project 3 can be a transformative experience

- You may become a different programmer
 - Techniques, attitudes

Employers care about this experience

Alumni care about this experience

#include <end_of_412_concern_stories>

Exhortation



Please read the project handout today!

You need to plan how to get to Checkpoint 1

- Simple loader
- Dummy VM
- Getting from kernel mode to user mode
- Getting from user mode to kernel mode
- Lots of faults
 - Solving them will require “story telling”

Encouragement



This can be done

Stay on track

- Make all checkpoints
- Don't ignore the plan of attack
- Don't postpone merges

Fall 2004

- All groups turned in working kernels
- Let's do it again!



Good Luck on
Project 3!

