

Probabilistic and Bayesian Analytics

Note to other teachers and users of these slides. Andrew would be delighted if you found this source material useful in giving your own lectures. Feel free to use these slides verbatim, or to modify them to fit your own needs. PowerPoint originals are available. If you make use of a significant portion of these slides in your own lecture, please include this message, or the following link to the source repository of Andrew's tutorials: <http://www.cs.cmu.edu/~awm/tutorials>. Comments and corrections gratefully received.

Andrew W. Moore
Professor
School of Computer Science
Carnegie Mellon University

www.cs.cmu.edu/~awm
awm@cs.cmu.edu
412-268-7599

Copyright © Andrew W. Moore

Slide 1

Probability

- The world is a very uncertain place
- 30 years of Artificial Intelligence and Database research danced around this fact
- And then a few AI researchers decided to use some ideas from the eighteenth century

Copyright © Andrew W. Moore

Slide 2

What we're going to do

- We will review the fundamentals of probability.
- It's really going to be worth it
- In this lecture, you'll see an example of probabilistic analytics in action: Bayes Classifiers

Copyright © Andrew W. Moore

Slide 3

Discrete Random Variables

- A is a Boolean-valued random variable if A denotes an event, and there is some degree of uncertainty as to whether A occurs.
- Examples
 - A = The US president in 2023 will be male
 - A = You wake up tomorrow with a headache
 - A = You have Ebola

Copyright © Andrew W. Moore

Slide 4

Probabilities

- We write $P(A)$ as “the fraction of possible worlds in which A is true”
- We could at this point spend 2 hours on the philosophy of this.
- But we won't.

Copyright © Andrew W. Moore

Slide 5

Visualizing A

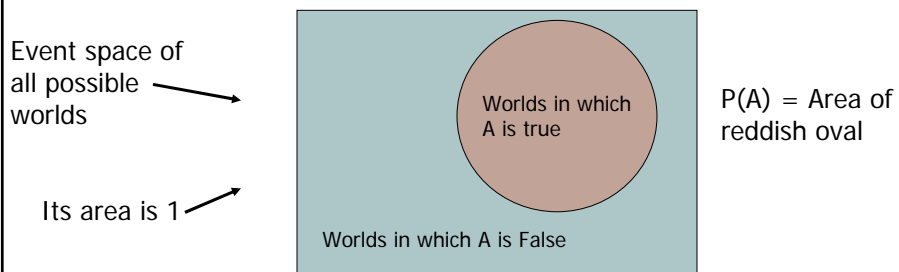

Copyright © Andrew W. Moore

Slide 6



The Axioms of Probability

- $0 \leq P(A) \leq 1$
- $P(\text{True}) = 1$
- $P(\text{False}) = 0$
- $P(A \text{ or } B) = P(A) + P(B) - P(A \text{ and } B)$

Where do these axioms come from? Were they “discovered”?
Answers coming up later.

Interpreting the axioms

- $0 \leq P(A) \leq 1$
- $P(\text{True}) = 1$
- $P(\text{False}) = 0$
- $P(A \text{ or } B) = P(A) + P(B) - P(A \text{ and } B)$

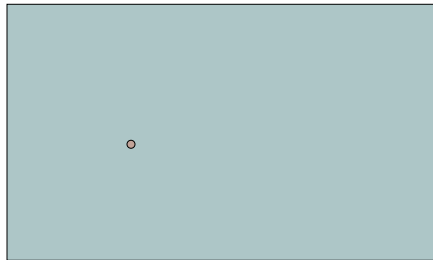

The area of A can't get any smaller than 0

And a zero area would mean no world could ever have A true

Copyright © Andrew W. Moore

Slide 9

Interpreting the axioms

- $0 \leq P(A) \leq 1$
- $P(\text{True}) = 1$
- $P(\text{False}) = 0$
- $P(A \text{ or } B) = P(A) + P(B) - P(A \text{ and } B)$

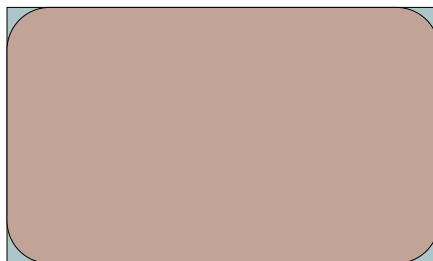

The area of A can't get any bigger than 1

And an area of 1 would mean all worlds will have A true

Copyright © Andrew W. Moore

Slide 10

Interpreting the axioms

- $0 \leq P(A) \leq 1$
- $P(\text{True}) = 1$
- $P(\text{False}) = 0$
- $P(A \text{ or } B) = P(A) + P(B) - P(A \text{ and } B)$

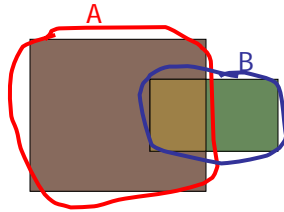

Copyright © Andrew W. Moore

Slide 11

Interpreting the axioms

- $0 \leq P(A) \leq 1$
- $P(\text{True}) = 1$
- $P(\text{False}) = 0$
- $P(A \text{ or } B) = P(A) + P(B) - P(A \text{ and } B)$

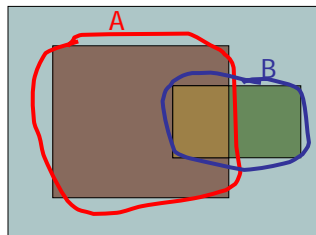

Simple addition and subtraction

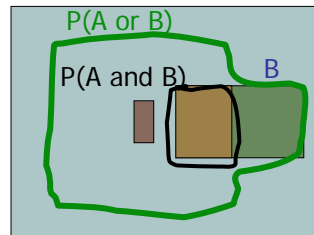

Copyright © Andrew W. Moore

Slide 12

These Axioms are Not to be Trifled With

- There have been attempts to do different methodologies for uncertainty
 - Fuzzy Logic
 - Three-valued logic
 - Dempster-Shafer
 - Non-monotonic reasoning
- But the axioms of probability are the only system with this property:
If you gamble using them you can't be unfairly exploited by an opponent using some other system [di Finetti 1931]

Copyright © Andrew W. Moore

Slide 13

Theorems from the Axioms

- $0 \leq P(A) \leq 1$, $P(\text{True}) = 1$, $P(\text{False}) = 0$
- $P(A \text{ or } B) = P(A) + P(B) - P(A \text{ and } B)$

From these we can prove:

$$P(\text{not } A) = P(\sim A) = 1 - P(A)$$

- How?

Copyright © Andrew W. Moore

Slide 14

Side Note

- I am inflicting these proofs on you for two reasons:
 1. These kind of manipulations will need to be second nature to you if you use probabilistic analytics in depth
 2. Suffering is good for you

Copyright © Andrew W. Moore

Slide 15

Another important theorem

- $0 \leq P(A) \leq 1$, $P(\text{True}) = 1$, $P(\text{False}) = 0$
- $P(A \text{ or } B) = P(A) + P(B) - P(A \text{ and } B)$

From these we can prove:

$$P(A) = P(A \wedge B) + P(A \wedge \sim B)$$

- How?

Copyright © Andrew W. Moore

Slide 16

Multivalued Random Variables

- Suppose A can take on more than 2 values
- A is a *random variable with arity k* if it can take on exactly one value out of $\{v_1, v_2, \dots, v_k\}$
- Thus...

$$P(A = v_i \wedge A = v_j) = 0 \text{ if } i \neq j$$

$$P(A = v_1 \vee A = v_2 \vee \dots \vee A = v_k) = 1$$

Copyright © Andrew W. Moore

Slide 17

An easy fact about Multivalued Random Variables:

- Using the axioms of probability...
 $0 \leq P(A) \leq 1$, $P(\text{True}) = 1$, $P(\text{False}) = 0$
 $P(A \text{ or } B) = P(A) + P(B) - P(A \text{ and } B)$

- And assuming that A obeys...

$$P(A = v_i \wedge A = v_j) = 0 \text{ if } i \neq j$$

$$P(A = v_1 \vee A = v_2 \vee \dots \vee A = v_k) = 1$$

- It's easy to prove that

$$P(A = v_1 \vee A = v_2 \vee \dots \vee A = v_i) = \sum_{j=1}^i P(A = v_j)$$

Copyright © Andrew W. Moore

Slide 18

An easy fact about Multivalued Random Variables:

- Using the axioms of probability...

$$0 \leq P(A) \leq 1, P(\text{True}) = 1, P(\text{False}) = 0$$

$$P(A \text{ or } B) = P(A) + P(B) - P(A \text{ and } B)$$

- And assuming that A obeys...

$$P(A = v_i \wedge A = v_j) = 0 \text{ if } i \neq j$$

$$P(A = v_1 \vee A = v_2 \vee A = v_k) = 1$$

- It's easy to prove that

$$P(A = v_1 \vee A = v_2 \vee A = v_i) = \sum_{j=1}^i P(A = v_j)$$

- And thus we can prove

$$\sum_{j=1}^k P(A = v_j) = 1$$

Copyright © Andrew W. Moore

Slide 19

Another fact about Multivalued Random Variables:

- Using the axioms of probability...

$$0 \leq P(A) \leq 1, P(\text{True}) = 1, P(\text{False}) = 0$$

$$P(A \text{ or } B) = P(A) + P(B) - P(A \text{ and } B)$$

- And assuming that A obeys...

$$P(A = v_i \wedge A = v_j) = 0 \text{ if } i \neq j$$

$$P(A = v_1 \vee A = v_2 \vee A = v_k) = 1$$

- It's easy to prove that

$$P(B \wedge [A = v_1 \vee A = v_2 \vee A = v_i]) = \sum_{j=1}^i P(B \wedge A = v_j)$$

Copyright © Andrew W. Moore

Slide 20

Another fact about Multivalued Random Variables:

- Using the axioms of probability...

$$0 \leq P(A) \leq 1, P(\text{True}) = 1, P(\text{False}) = 0$$

$$P(A \text{ or } B) = P(A) + P(B) - P(A \text{ and } B)$$

- And assuming that A obeys...

$$P(A = v_i \wedge A = v_j) = 0 \text{ if } i \neq j$$

$$P(A = v_1 \vee A = v_2 \vee A = v_k) = 1$$

- It's easy to prove that

$$P(B \wedge [A = v_1 \vee A = v_2 \vee A = v_i]) = \sum_{j=1}^i P(B \wedge A = v_j)$$

- And thus we can prove

$$P(B) = \sum_{j=1}^k P(B \wedge A = v_j)$$

Copyright © Andrew W. Moore

Slide 21

Elementary Probability in Pictures

- $P(\sim A) + P(A) = 1$

Copyright © Andrew W. Moore

Slide 22

Elementary Probability in Pictures

- $P(B) = P(B \wedge A) + P(B \wedge \sim A)$

Copyright © Andrew W. Moore

Slide 23

Elementary Probability in Pictures

$$\sum_{j=1}^k P(A = v_j) = 1$$

Copyright © Andrew W. Moore

Slide 24

Elementary Probability in Pictures

$$P(B) = \sum_{j=1}^k P(B \wedge A = v_j)$$

Copyright © Andrew W. Moore

Slide 25

Conditional Probability

- $P(A|B)$ = Fraction of worlds in which B is true that also have A true

H = "Have a headache"
F = "Coming down with Flu"

$P(H) = 1/10$
 $P(F) = 1/40$
 $P(H|F) = 1/2$

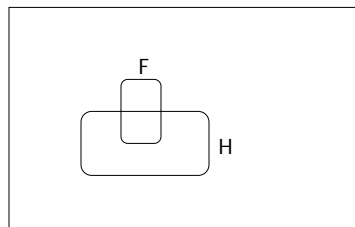

"Headaches are rare and flu is rarer, but if you're coming down with 'flu there's a 50-50 chance you'll have a headache."

Copyright © Andrew W. Moore

Slide 26

Conditional Probability

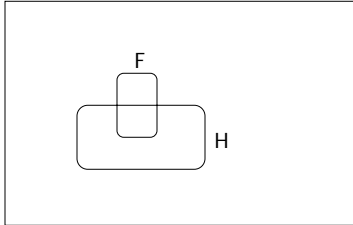

H = "Have a headache"
F = "Coming down with Flu"

$P(H) = 1/10$
 $P(F) = 1/40$
 $P(H|F) = 1/2$

$P(H|F)$ = Fraction of flu-inflicted worlds in which you have a headache

= #worlds with flu and headache

#worlds with flu

= Area of "H and F" region

Area of "F" region

= $P(H \wedge F)$

 $P(F)$

Copyright © Andrew W. Moore

Slide 27

Definition of Conditional Probability

$$P(A|B) = \frac{P(A \wedge B)}{P(B)}$$

Corollary: The Chain Rule

$$P(A \wedge B) = P(A|B) P(B)$$

Copyright © Andrew W. Moore

Slide 28

Probabilistic Inference

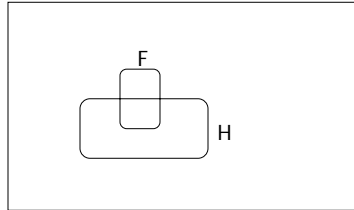

H = "Have a headache"
F = "Coming down with Flu"

$$P(H) = 1/10$$
$$P(F) = 1/40$$
$$P(H|F) = 1/2$$

One day you wake up with a headache. You think: "Drat! 50% of flus are associated with headaches so I must have a 50-50 chance of coming down with flu"

Is this reasoning good?

Copyright © Andrew W. Moore

Slide 29

Probabilistic Inference

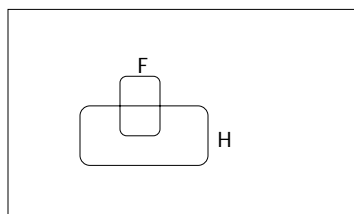

H = "Have a headache"
F = "Coming down with Flu"

$$P(H) = 1/10$$
$$P(F) = 1/40$$
$$P(H|F) = 1/2$$

$$P(F \wedge H) = \dots$$

$$P(F|H) = \dots$$

Copyright © Andrew W. Moore

Slide 30

Another way to understand the intuition

Thanks to Jahanzeb Sherwani for contributing this explanation:

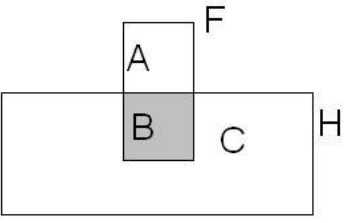

Let's say we have $P(F)$, $P(H)$, and $P(H|F)$, like in the example in class.

Area-wise, $P(F) = A + B$, $P(H) = B + C$,

Also, $P(H|F) = \frac{B}{A + B}$

Thus, to get the opposite conditional probability, ie, $P(F|H)$, we need to figure out $\frac{B}{B + C}$

Since we know $B / (A+B)$, we can get $B / (B+C)$ by multiplying by $(A+B)$ and dividing by $(B+C)$. But since we already calculated, $A+B = P(F)$, and $B+C = P(H)$, so we are actually multiplying by $P(F)$ and dividing by $P(H)$. Which is Bayes Rule:

$$P(F|H) = P(H|F) \cdot \frac{P(F)}{P(H)}$$

Copyright © Andrew W. Moore

Slide 31

What we just did...

$$P(B|A) = \frac{P(A \wedge B)}{P(A)} = \frac{P(A|B) P(B)}{P(A)}$$

This is Bayes Rule

Bayes, Thomas (1763) An essay towards solving a problem in the doctrine of chances. *Philosophical Transactions of the Royal Society of London*, 53:370-418



Copyright © Andrew W. Moore

Slide 32

Using Bayes Rule to Gamble

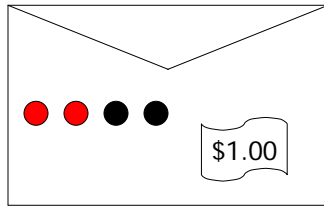

The "Win" envelope has a dollar and four beads in it

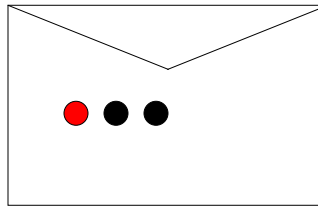

The "Lose" envelope has three beads and no money

Trivial question: someone draws an envelope at random and offers to sell it to you. How much should you pay?

Copyright © Andrew W. Moore

Slide 33

Using Bayes Rule to Gamble

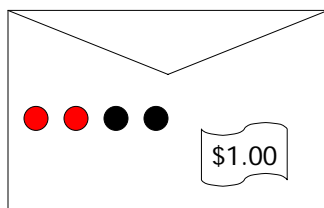

The "Win" envelope has a dollar and four beads in it

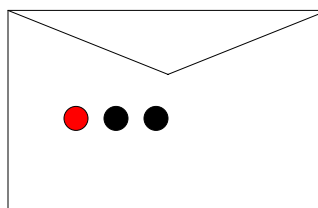

The "Lose" envelope has three beads and no money

Interesting question: before deciding, you are allowed to see one bead drawn from the envelope.

Suppose it's black: How much should you pay?

Suppose it's red: How much should you pay?

Copyright © Andrew W. Moore

Slide 34

Calculation...

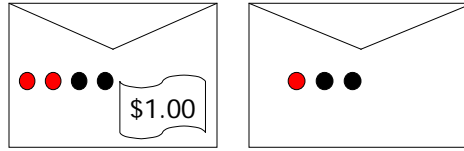

Copyright © Andrew W. Moore

Slide 35

More General Forms of Bayes Rule

$$P(A|B) = \frac{P(B|A)P(A)}{P(B|A)P(A) + P(B|\sim A)P(\sim A)}$$

$$P(A|B \wedge X) = \frac{P(B|A \wedge X)P(A \wedge X)}{P(B \wedge X)}$$

Copyright © Andrew W. Moore

Slide 36

More General Forms of Bayes Rule

$$P(A=v_i | B) = \frac{P(B | A=v_i)P(A=v_i)}{\sum_{k=1}^{n_A} P(B | A=v_k)P(A=v_k)}$$

Copyright © Andrew W. Moore

Slide 37

Useful Easy-to-prove facts

$$P(A | B) + P(\neg A | B) = 1$$

$$\sum_{k=1}^{n_A} P(A = v_k | B) = 1$$

Copyright © Andrew W. Moore

Slide 38

The Joint Distribution

Example: Boolean variables A, B, C

Recipe for making a joint distribution of M variables:

The Joint Distribution

Example: Boolean variables A, B, C

Recipe for making a joint distribution of M variables:

1. Make a truth table listing all combinations of values of your variables (if there are M Boolean variables then the table will have 2^M rows).

A	B	C
0	0	0
0	0	1
0	1	0
0	1	1
1	0	0
1	0	1
1	1	0
1	1	1

The Joint Distribution

Example: Boolean variables A, B, C

Recipe for making a joint distribution of M variables:

1. Make a truth table listing all combinations of values of your variables (if there are M Boolean variables then the table will have 2^M rows).
2. For each combination of values, say how probable it is.

A	B	C	Prob
0	0	0	0.30
0	0	1	0.05
0	1	0	0.10
0	1	1	0.05
1	0	0	0.05
1	0	1	0.10
1	1	0	0.25
1	1	1	0.10

Copyright © Andrew W. Moore

Slide 41

The Joint Distribution

Example: Boolean variables A, B, C

Recipe for making a joint distribution of M variables:

1. Make a truth table listing all combinations of values of your variables (if there are M Boolean variables then the table will have 2^M rows).
2. For each combination of values, say how probable it is.
3. If you subscribe to the axioms of probability, those numbers must sum to 1.



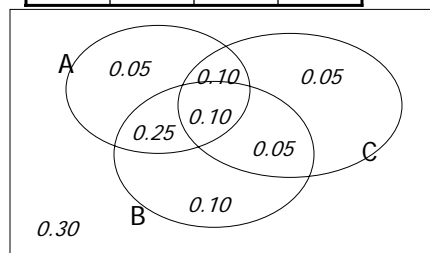



A	B	C	Prob
0	0	0	0.30
0	0	1	0.05
0	1	0	0.10
0	1	1	0.05
1	0	0	0.05
1	0	1	0.10
1	1	0	0.25
1	1	1	0.10



Copyright © Andrew W. Moore

Slide 42

Using the Joint

gender	hours_worked	wealth	
Female	v0:40.5-	poor	0.253122 
		rich	0.0245895 
	v1:40.5+	poor	0.0421768 
		rich	0.0116293 
Male	v0:40.5-	poor	0.331313 
		rich	0.0971295 
	v1:40.5+	poor	0.134106 
		rich	0.105933 









Once you have the JD you can ask for the probability of any logical expression involving your attribute

$$P(E) = \sum_{\text{rows matching } E} P(\text{row})$$

Copyright © Andrew W. Moore

Slide 43

Using the Joint

gender	hours_worked	wealth	
Female	v0:40.5-	poor	0.253122 
		rich	0.0245895 
	v1:40.5+	poor	0.0421768 
		rich	0.0116293 
Male	v0:40.5-	poor	0.331313 
		rich	0.0971295 
	v1:40.5+	poor	0.134106 
		rich	0.105933 

$$P(\text{Poor Male}) = 0.4654$$

$$P(E) = \sum_{\text{rows matching } E} P(\text{row})$$

Copyright © Andrew W. Moore

Slide 44

Using the Joint

gender	hours_worked	wealth	
Female	v0:40.5-	poor	0.253122
		rich	0.0245895
	v1:40.5+	poor	0.0421768
		rich	0.0116293
Male	v0:40.5-	poor	0.331313
		rich	0.0971295
	v1:40.5+	poor	0.134106
		rich	0.105933

$$P(\text{Poor}) = 0.7604$$

$$P(E) = \sum_{\text{rows matching } E} P(\text{row})$$

Copyright © Andrew W. Moore

Slide 45

Inference with the Joint

gender	hours_worked	wealth	
Female	v0:40.5-	poor	0.253122
		rich	0.0245895
	v1:40.5+	poor	0.0421768
		rich	0.0116293
Male	v0:40.5-	poor	0.331313
		rich	0.0971295
	v1:40.5+	poor	0.134106
		rich	0.105933

$$P(E_1 | E_2) = \frac{P(E_1 \wedge E_2)}{P(E_2)} = \frac{\sum_{\text{rows matching } E_1 \text{ and } E_2} P(\text{row})}{\sum_{\text{rows matching } E_2} P(\text{row})}$$

Copyright © Andrew W. Moore

Slide 46

Inference with the Joint

gender	hours_worked	wealth	
Female	v0:40.5-	poor	0.253122
		rich	0.0245895
	v1:40.5+	poor	0.0421768
		rich	0.0116293
Male	v0:40.5-	poor	0.331313
		rich	0.0971295
	v1:40.5+	poor	0.134106
		rich	0.105933

$$P(E_1 | E_2) = \frac{P(E_1 \wedge E_2)}{P(E_2)} = \frac{\sum_{\text{rows matching } E_1 \text{ and } E_2} P(\text{row})}{\sum_{\text{rows matching } E_2} P(\text{row})}$$

$$P(\text{Male} | \text{Poor}) = 0.4654 / 0.7604 = 0.612$$

Copyright © Andrew W. Moore

Slide 47

Inference is a big deal

- I've got this evidence. What's the chance that this conclusion is true?
 - I've got a sore neck: how likely am I to have meningitis?
 - I see my lights are out and it's 9pm. What's the chance my spouse is already asleep?

Copyright © Andrew W. Moore

Slide 48

Inference is a big deal

- I've got this evidence. What's the chance that this conclusion is true?
 - I've got a sore neck: how likely am I to have meningitis?
 - I see my lights are out and it's 9pm. What's the chance my spouse is already asleep?

Copyright © Andrew W. Moore

Slide 49

Inference is a big deal

- I've got this evidence. What's the chance that this conclusion is true?
 - I've got a sore neck: how likely am I to have meningitis?
 - I see my lights are out and it's 9pm. What's the chance my spouse is already asleep?
- There's a thriving set of industries growing based around Bayesian Inference. Highlights are: Medicine, Pharma, Help Desk Support, Engine Fault Diagnosis

Copyright © Andrew W. Moore

Slide 50

Where do Joint Distributions come from?

- Idea One: Expert Humans
- Idea Two: Simpler probabilistic facts and some algebra

Example: Suppose you knew

$$\begin{array}{ll} P(A) = 0.7 & P(C|A \wedge B) = 0.1 \\ P(B|A) = 0.2 & P(C|A \wedge \sim B) = 0.8 \\ P(B|\sim A) = 0.1 & P(C|\sim A \wedge B) = 0.3 \\ & P(C|\sim A \wedge \sim B) = 0.1 \end{array}$$

Then you can automatically compute the JD using the chain rule

$$P(A=x \wedge B=y \wedge C=z) = P(C=z|A=x \wedge B=y) P(B=y|A=x) P(A=x)$$

In another lecture: Bayes Nets, a systematic way to do this.

Copyright © Andrew W. Moore

Slide 51

Where do Joint Distributions come from?

- Idea Three: Learn them from data!

Prepare to see one of the most impressive learning algorithms you'll come across in the entire course....

Copyright © Andrew W. Moore

Slide 52

Learning a joint distribution

Build a JD table for your attributes in which the probabilities are unspecified

A	B	C	Prob
0	0	0	?
0	0	1	?
0	1	0	?
0	1	1	?
1	0	0	?
1	0	1	?
1	1	0	?
1	1	1	?

The fill in each row with

$$\hat{P}(\text{row}) = \frac{\text{records matching row}}{\text{total number of records}}$$

A	B	C	Prob
0	0	0	0.30
0	0	1	0.05
0	1	0	0.10
0	1	1	0.05
1	0	0	0.05
1	0	1	0.10
1	1	0	0.25
1	1	1	0.10

Fraction of all records in which A and B are True but C is False

Example of Learning a Joint

- This Joint was obtained by learning from three attributes in the UCI "Adult" Census Database [Kohavi 1995]

gender	hours_worked	wealth	prob
Female	v0:40.5-	poor	0.253122
		rich	0.0245895
	v1:40.5+	poor	0.0421768
		rich	0.0116293
Male	v0:40.5-	poor	0.331313
		rich	0.0971295
	v1:40.5+	poor	0.134106
		rich	0.105933

Where are we?

- We have recalled the fundamentals of probability
- We have become content with what JDs are and how to use them
- And we even know how to learn JDs from data.

Copyright © Andrew W. Moore

Slide 55

Density Estimation

- Our Joint Distribution learner is our first example of something called Density Estimation
- A Density Estimator learns a mapping from a set of attributes to a Probability

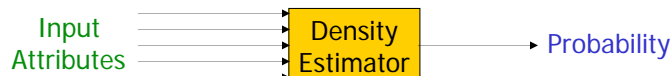

Copyright © Andrew W. Moore

Slide 56

Density Estimation

- Compare it against the two other major kinds of models:

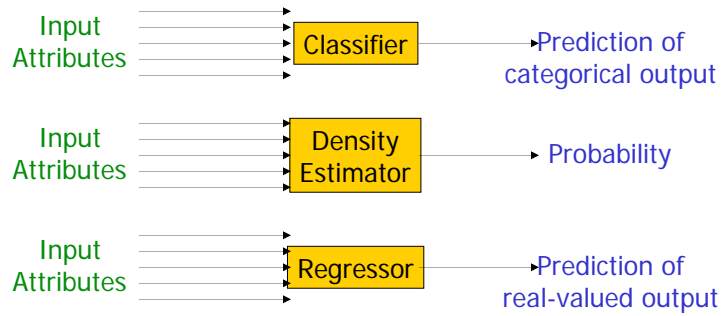

Copyright © Andrew W. Moore

Slide 57

Evaluating Density Estimation

Test-set criterion for estimating performance on future data*

** See the Decision Tree or Cross Validation lecture for more detail*

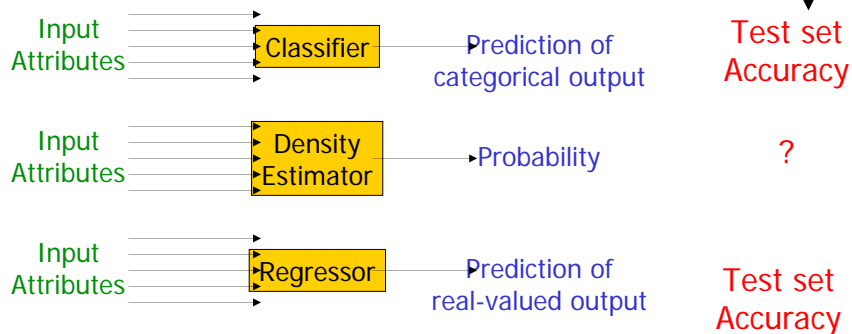

Copyright © Andrew W. Moore

Slide 58

Evaluating a density estimator

- Given a record \mathbf{x} , a density estimator M can tell you how likely the record is:

$$\hat{P}(\mathbf{x}/M)$$

- Given a dataset with R records, a density estimator can tell you how likely the dataset is:

(Under the assumption that all records were **independently** generated from the Density Estimator's JD)

$$\hat{P}(\text{dataset}/M) = \hat{P}(\mathbf{x}_1 \wedge \mathbf{x}_2 \dots \wedge \mathbf{x}_R/M) = \prod_{k=1}^R \hat{P}(\mathbf{x}_k/M)$$

Copyright © Andrew W. Moore

Slide 59

A small dataset: Miles Per Gallon

192
Training
Set
Records

mpg	modelyear	maker
good	75to78	asia
bad	70to74	america
bad	75to78	europa
bad	70to74	america
bad	70to74	america
bad	70to74	asia
bad	70to74	asia
bad	75to78	america
:	:	:
:	:	:
:	:	:
bad	70to74	america
good	79to83	america
bad	75to78	america
good	79to83	america
bad	75to78	america
good	79to83	america
good	79to83	america
bad	70to74	america
good	75to78	europa
bad	75to78	europa

From the UCI repository (thanks to Ross Quinlan)

Copyright © Andrew W. Moore

Slide 60

A small dataset: Miles Per Gallon

192
Training
Set
Records

mpg	modelyear	maker
good	75to78	asia
bad	70to74	america
bad	75to78	europa
bad	70to74	america
bad	70to74	america
bad	70to74	asia
bad	70to74	asia
bad	75to78	america
:	:	:
:	:	:
:	:	:
:	:	:
bad	70to74	america
good	79to83	america
bad	75to78	america
good	79to83	america
bad	75to78	america
good	79to83	america
good	79to83	america
bad	70to74	america
good	75to78	europa
bad	75to78	europa

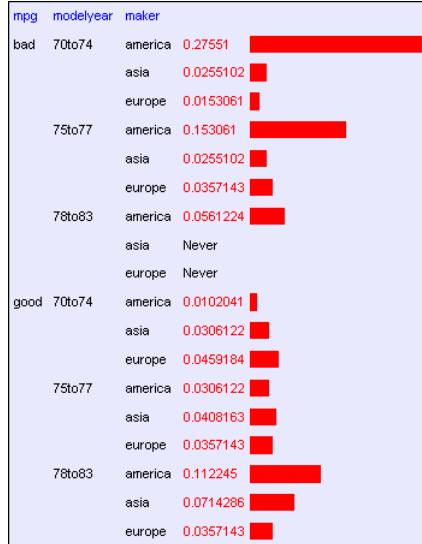

Copyright © Andrew W. Moore

Slide 61

A small dataset: Miles Per Gallon

192
Training
Set

mpg	modelyear	maker
good	75to78	asia
bad	70to74	america
bad	75to78	europa
bad	70to74	america
bad	70to74	america
bad	70to74	asia
bad	70to74	asia
bad	75to78	america
:	:	:
:	:	:
:	:	:
:	:	:
bad	70to74	america
good	79to83	america
bad	75to78	america
good	79to83	america
bad	75to78	america
good	79to83	america
good	79to83	america
bad	70to74	america
good	75to78	europa
bad	75to78	europa

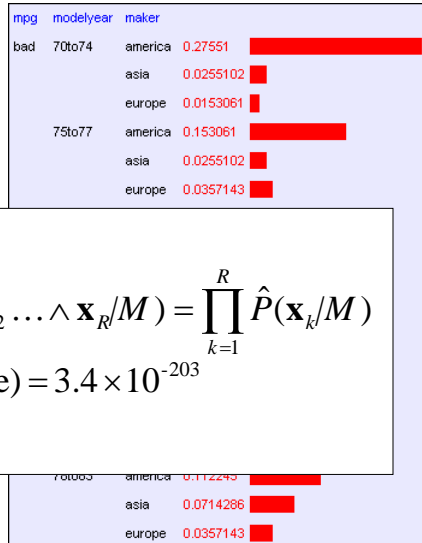

$$\hat{P}(\text{dataset}/M) = \hat{P}(\mathbf{x}_1 \wedge \mathbf{x}_2 \dots \wedge \mathbf{x}_R/M) = \prod_{k=1}^R \hat{P}(\mathbf{x}_k/M)$$

$$= (\text{in this case}) = 3.4 \times 10^{-203}$$

Copyright © Andrew W. Moore

Slide 62

Log Probabilities

Since probabilities of datasets get so small we usually use log probabilities

$$\log \hat{P}(\text{dataset}/M) = \log \prod_{k=1}^R \hat{P}(\mathbf{x}_k/M) = \sum_{k=1}^R \log \hat{P}(\mathbf{x}_k/M)$$

Copyright © Andrew W. Moore

Slide 63

A small dataset: Miles Per Gallon

192
Training
Set

mpg	modelyear	maker
good	75to78	asia
bad	70to74	america
bad	75to78	europa
bad	70to74	america
bad	70to74	america
bad	70to74	asia
bad	70to74	asia

mpg	modelyear	maker	probability
bad	70to74	america	0.27551
		asia	0.0255102
		europa	0.0153061
75to77		america	0.153061
		asia	0.0255102
		europa	0.0357143

$$\log \hat{P}(\text{dataset}/M) = \log \prod_{k=1}^R \hat{P}(\mathbf{x}_k/M) = \sum_{k=1}^R \log \hat{P}(\mathbf{x}_k/M)$$

= (in this case) = -466.19

mpg	modelyear	maker	probability
70to75		america	0.112243
		asia	0.0714286
		europa	0.0357143

Copyright © Andrew W. Moore

Slide 64

Summary: The Good News

- We have a way to learn a Density Estimator from data.
- Density estimators can do many good things...
 - Can sort the records by probability, and thus spot weird records (anomaly detection)
 - Can do inference: $P(E1|E2)$
Automatic Doctor / Help Desk etc
 - Ingredient for Bayes Classifiers (see later)

Copyright © Andrew W. Moore

Slide 65

Summary: The Bad News

- Density estimation by directly learning the joint is trivial, mindless and dangerous

Copyright © Andrew W. Moore

Slide 66

Using a test set

	Set Size	Log likelihood
Training Set	196	-466.1905
Test Set	196	-614.6157

An independent test set with 196 cars has a worse log likelihood

(actually it's a billion quintillion quintillion quintillion quintillion times less likely)

...Density estimators can overfit. And the full joint density estimator is the overfittest of them all!

Overfitting Density Estimators

If **this** ever happens, it means there are certain combinations that we learn are impossible

mpg	modelyear	maker	density
bad	70to74	america	0.27551
		asia	0.0255102
		europa	0.0153061
75to77		america	0.153061
		asia	0.0255102
		europa	0.0357143
78to83		america	0.0561224
		asia	Never
		europa	Never
good	70to74	america	0.0102041

$$\log \hat{P}(\text{testset}/M) = \log \prod_{k=1}^R \hat{P}(\mathbf{x}_k/M) = \sum_{k=1}^R \log \hat{P}(\mathbf{x}_k/M)$$

$$= -\infty \text{ if for any } k \hat{P}(\mathbf{x}_k/M) = 0$$

Using a test set

	Set Size	Log likelihood
Training Set	196	-466.1905
Test Set	196	-614.6157

The only reason that our test set didn't score -infinity is that my code is hard-wired to always predict a probability of at least one in 10^{20}

We need Density Estimators that are less prone to overfitting

Copyright © Andrew W. Moore

Slide 69

Naïve Density Estimation

The problem with the Joint Estimator is that it just mirrors the training data.

We need something which generalizes more usefully.

The **naïve model** generalizes strongly:

Assume that each attribute is distributed independently of any of the other attributes.

Copyright © Andrew W. Moore

Slide 70

Independently Distributed Data

- Let $x[i]$ denote the i th field of record x .
- The independently distributed assumption says that for any $i, v, u_1, u_2, \dots, u_{i-1}, u_{i+1}, \dots, u_M$

$$P(x[i] = v \mid x[1] = u_1, x[2] = u_2, \dots, x[i-1] = u_{i-1}, x[i+1] = u_{i+1}, \dots, x[M] = u_M) \\ = P(x[i] = v)$$

- Or in other words, $x[i]$ is independent of $\{x[1], x[2], \dots, x[i-1], x[i+1], \dots, x[M]\}$
- This is often written as

$$x[i] \perp \{x[1], x[2], \dots, x[i-1], x[i+1], \dots, x[M]\}$$

Copyright © Andrew W. Moore

Slide 71

A note about independence

- Assume A and B are Boolean Random Variables. Then

“ A and B are independent”

if and only if

$$P(A|B) = P(A)$$

- “ A and B are independent” is often notated as

$$A \perp B$$

Copyright © Andrew W. Moore

Slide 72

Independence Theorems

- Assume $P(A|B) = P(A)$
- Then $P(A \wedge B) =$

$$= P(A) P(B)$$

- Assume $P(A|B) = P(A)$
- Then $P(B|A) =$

$$= P(B)$$

Copyright © Andrew W. Moore

Slide 73

Independence Theorems

- Assume $P(A|B) = P(A)$
- Then $P(\sim A|B) =$

$$= P(\sim A)$$

- Assume $P(A|B) = P(A)$
- Then $P(A|\sim B) =$

$$= P(A)$$

Copyright © Andrew W. Moore

Slide 74

Multivalued Independence

For multivalued Random Variables A and B,

$$A \perp B$$

if and only if

$$\forall u, v : P(A = u \mid B = v) = P(A = u)$$

from which you can then prove things like...

$$\forall u, v : P(A = u \wedge B = v) = P(A = u)P(B = v)$$

$$\forall u, v : P(B = v \mid A = u) = P(B = v)$$

Copyright © Andrew W. Moore

Slide 75

Back to Naïve Density Estimation

- Let $x[i]$ denote the i 'th field of record x :
- Naïve DE assumes $x[i]$ is independent of $\{x[1], x[2], \dots, x[i-1], x[i+1], \dots, x[M]\}$
- Example:
 - Suppose that each record is generated by randomly shaking a green dice and a red dice
 - Dataset 1: A = red value, B = green value
 - Dataset 2: A = red value, B = sum of values
 - Dataset 3: A = sum of values, B = difference of values
 - Which of these datasets violates the naïve assumption?

Copyright © Andrew W. Moore

Slide 76

Using the Naïve Distribution

- Once you have a Naïve Distribution you can easily compute any row of the joint distribution.
- Suppose A , B , C and D are independently distributed. What is $P(A \wedge \sim B \wedge C \wedge \sim D)$?

Copyright © Andrew W. Moore

Slide 77

Using the Naïve Distribution

- Once you have a Naïve Distribution you can easily compute any row of the joint distribution.
- Suppose A , B , C and D are independently distributed. What is $P(A \wedge \sim B \wedge C \wedge \sim D)$?

$$= P(A | \sim B \wedge C \wedge \sim D) P(\sim B \wedge C \wedge \sim D)$$

$$= P(A) P(\sim B \wedge C \wedge \sim D)$$

$$= P(A) P(\sim B | C \wedge \sim D) P(C \wedge \sim D)$$

$$= P(A) P(\sim B) P(C \wedge \sim D)$$

$$= P(A) P(\sim B) P(C | \sim D) P(\sim D)$$

$$= P(A) P(\sim B) P(C) P(\sim D)$$

Copyright © Andrew W. Moore

Slide 78

Naïve Distribution General Case

- Suppose $x[1], x[2], \dots, x[M]$ are independently distributed.

$$P(x[1] = u_1, x[2] = u_2, \dots, x[M] = u_M) = \prod_{k=1}^M P(x[k] = u_k)$$

- So if we have a Naïve Distribution we can construct any row of the implied Joint Distribution on demand.
- So we can do any inference
- But how do we learn a Naïve Density Estimator?

Copyright © Andrew W. Moore

Slide 79

Learning a Naïve Density Estimator

$$\hat{P}(x[i] = u) = \frac{\text{\# records in which } x[i] = u}{\text{total number of records}}$$

Another trivial learning algorithm!

Copyright © Andrew W. Moore

Slide 80

Contrast

Joint DE	Naïve DE
Can model anything	Can model only very boring distributions
No problem to model "C is a noisy copy of A"	Outside Naïve's scope
Given 100 records and more than 6 Boolean attributes will screw up badly	Given 100 records and 10,000 multivalued attributes will be fine

Copyright © Andrew W. Moore

Slide 81

Empirical Results: "Hopeless"

The "hopeless" dataset consists of 40,000 records and 21 Boolean attributes called a,b,c, ... u. Each attribute in each record is generated 50-50 randomly as 0 or 1.

Name	Model	Parameters	LogLike
Model1	joint	submodel=gauss gausstype=general	-272625 +/- 301.109
Model2	naive	submodel=gauss gausstype=general	-58225.6 +/- 0.554747

Average test set log probability during 10 folds of k-fold cross-validation*
Described in a future Andrew lecture

Despite the vast amount of data, "Joint" overfits hopelessly and does much worse

Copyright © Andrew W. Moore

Slide 82

Empirical Results: "Logical"

The "logical" dataset consists of 40,000 records and 4 Boolean attributes called a,b,c,d where a,b,c are generated 50-50 randomly as 0 or 1. $D = A \wedge \sim C$, except that in 10% of records it is flipped

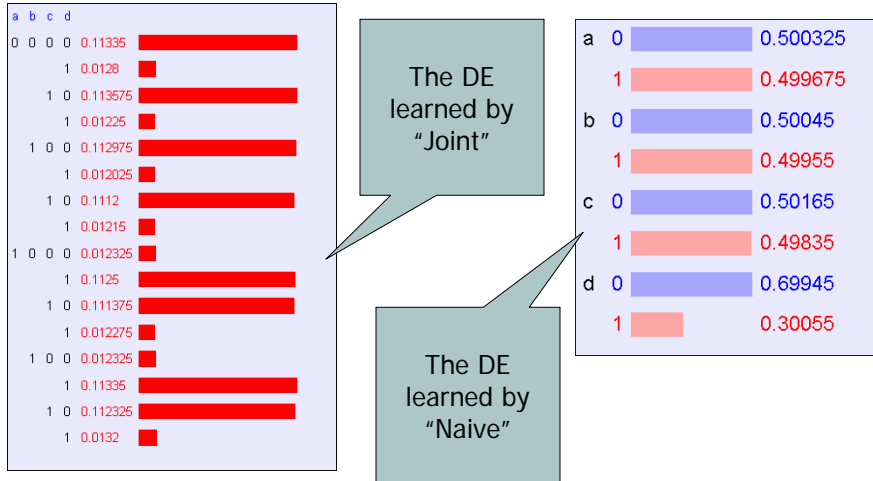

Copyright © Andrew W. Moore

Slide 83

Empirical Results: "Logical"

The "logical" dataset consists of 40,000 records and 4 Boolean attributes called a,b,c,d where a,b,c are generated 50-50 randomly as 0 or 1. $D = A \wedge \sim C$, except that in 10% of records it is flipped

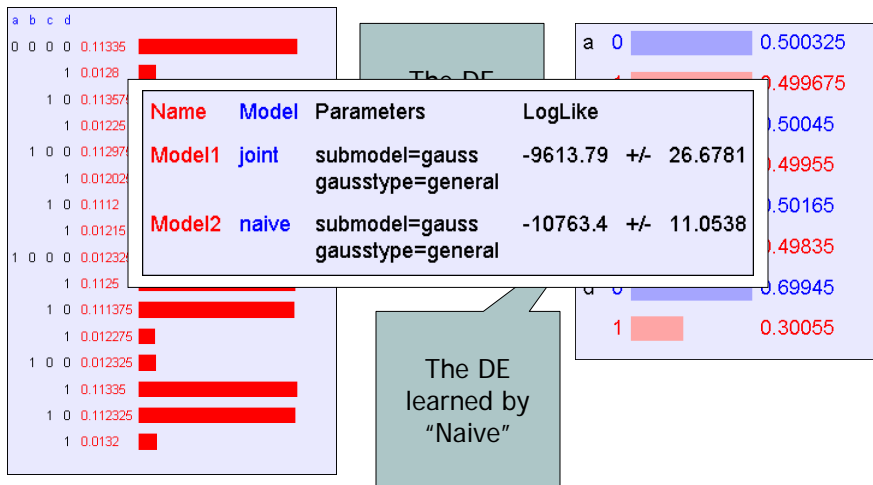

Copyright © Andrew W. Moore

Slide 84

Empirical Results: "MPG"

The "MPG" dataset consists of 392 records and 8 attributes

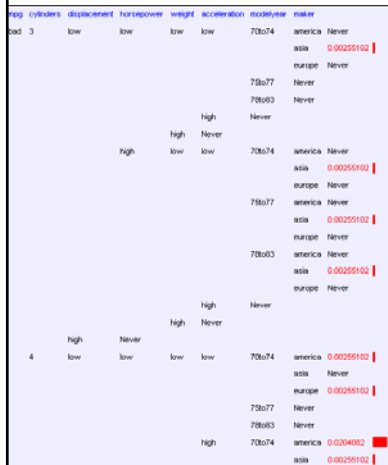

A tiny part of the DE learned by "Joint"

The DE learned by "Naive"

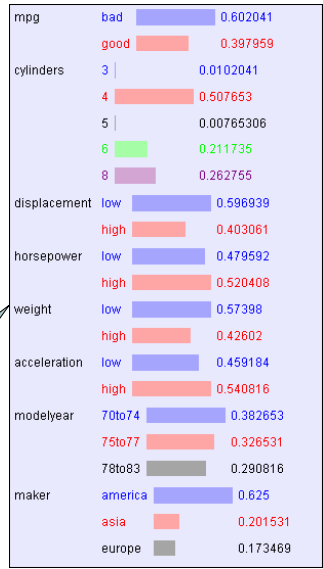

Empirical Results: "MPG"

The "MPG" dataset consists of 392 records and 8 attributes

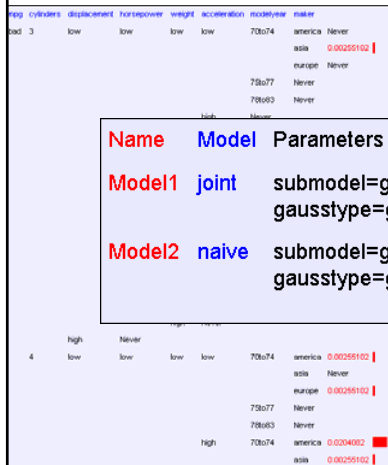

A tiny part of

Name	Model	Parameters	LogLike
Model1	joint	submodel=gauss gausstype=general	-472.486 +/- 77.2184
Model2	naive	submodel=gauss gausstype=general	-257.212 +/- 3.02246

The DE learned by "Naive"

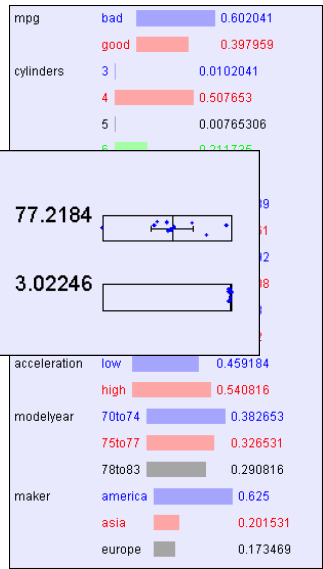

Empirical Results: "Weight vs. MPG"

Suppose we train only from the "Weight" and "MPG" attributes

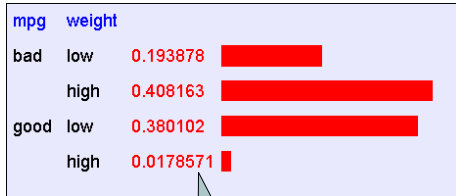

The DE learned by "Joint"

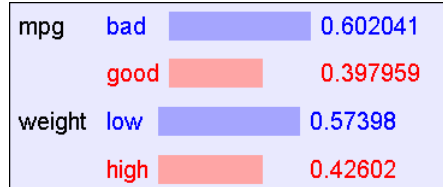

The DE learned by "Naive"

Copyright © Andrew W. Moore

Slide 87

Empirical Results: "Weight vs. MPG"

Suppose we train only from the "Weight" and "MPG" attributes

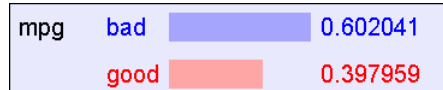
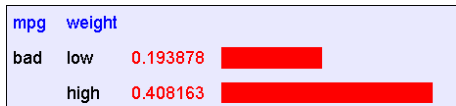

Name	Model	Parameters	LogLike	
Model1	joint	submodel=gauss gausstype=general	-44.3562 +/- 2.27547	
Model2	naive	submodel=gauss gausstype=general	-53.2231 +/- 0.610411	

learned by "Joint"

The DE learned by "Naive"

Copyright © Andrew W. Moore

Slide 88

“Weight vs. MPG”: The best that Naive can do

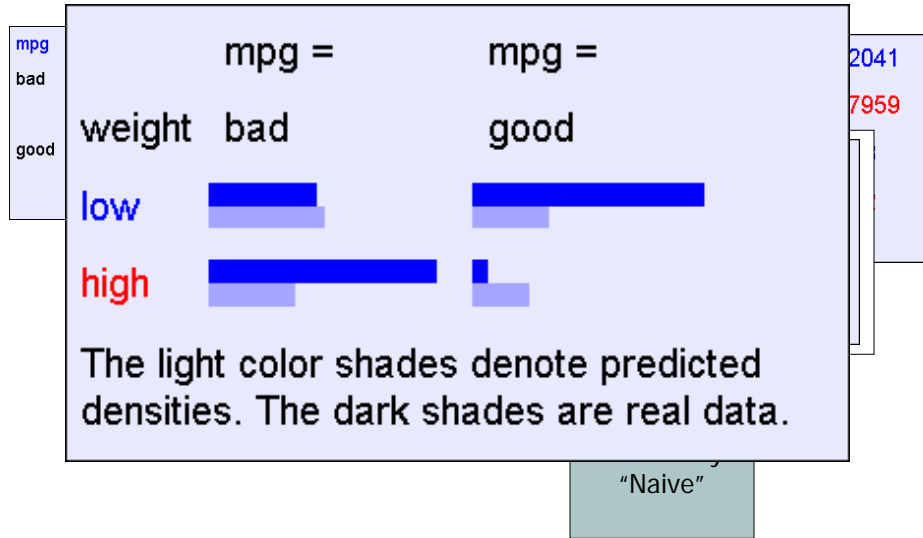

Copyright © Andrew W. Moore

Slide 89

Reminder: The Good News

- We have two ways to learn a Density Estimator from data.
- * In other lectures we'll see vastly more impressive Density Estimators (Mixture Models, Bayesian Networks, Density Trees, Kernel Densities and many more)
- Density estimators can do many good things...
 - Anomaly detection
 - Can do inference: $P(E1|E2)$ Automatic Doctor / Help Desk etc
 - Ingredient for Bayes Classifiers

Copyright © Andrew W. Moore

Slide 90

Bayes Classifiers

- A formidable and sworn enemy of decision trees

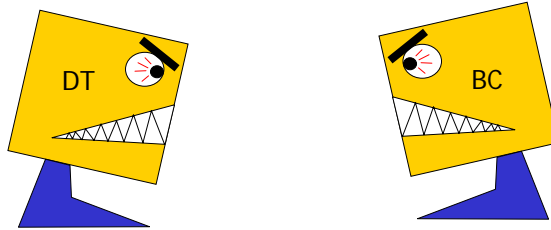

Copyright © Andrew W. Moore

Slide 91

How to build a Bayes Classifier

- Assume you want to predict output Y which has arity n_y and values v_1, v_2, \dots, v_{n_y}
- Assume there are m input attributes called X_1, X_2, \dots, X_m
- Break dataset into n_y smaller datasets called $DS_1, DS_2, \dots, DS_{n_y}$
- Define $DS_j =$ Records in which $Y=v_j$
- For each DS_j , learn Density Estimator M_j to model the input distribution among the $Y=v_j$ records.

Copyright © Andrew W. Moore

Slide 92

How to build a Bayes Classifier

- Assume you want to predict output Y which has arity n_Y and values V_1, V_2, \dots, V_{n_Y}
- Assume there are m input attributes called X_1, X_2, \dots, X_m
- Break dataset into n_Y smaller datasets called $DS_1, DS_2, \dots, DS_{n_Y}$
- Define $DS_i =$ Records in which $Y = V_i$
- For each DS_i , learn Density Estimator M_i to model the input distribution among the $Y = V_i$ records.
- M_i estimates $P(X_1, X_2, \dots, X_m / Y = V_i)$

Copyright © Andrew W. Moore

Slide 93

How to build a Bayes Classifier

- Assume you want to predict output Y which has arity n_Y and values V_1, V_2, \dots, V_{n_Y}
- Assume there are m input attributes called X_1, X_2, \dots, X_m
- Break dataset into n_Y smaller datasets called $DS_1, DS_2, \dots, DS_{n_Y}$
- Define $DS_i =$ Records in which $Y = V_i$
- For each DS_i , learn Density Estimator M_i to model the input distribution among the $Y = V_i$ records.
- M_i estimates $P(X_1, X_2, \dots, X_m / Y = V_i)$

- Idea: When a new set of input values ($X_1 = u_1, X_2 = u_2, \dots, X_m = u_m$) come along to be evaluated predict the value of Y that makes $P(X_1, X_2, \dots, X_m / Y = V_i)$ most likely

$$Y^{\text{predict}} = \underset{v}{\operatorname{argmax}} P(X_1 = u_1 \cdots X_m = u_m | Y = v)$$

Is this a good idea?

Copyright © Andrew W. Moore

Slide 94

How to build a ~~Bayes~~ Classifier

- Assume you want to predict output Y which has arity n_y and values V_1, V_2, \dots, V_{n_y}
- Assume there are m input attributes called X_1, X_2, \dots, X_m
- Break dataset into n_y smaller datasets called DS_i
- Define $DS_i =$ Records in which $Y = v_i$
- For each DS_i , learn Density Estimator M_i distribution among the $Y = v_i$ records.
- M_i estimates $P(X_1, X_2, \dots, X_m / Y = v_i)$
- Idea: When a new set of input values $(X_1 = u_1, X_2 = u_2, \dots, X_m = u_m)$ come along to be evaluated predict the value of Y that makes $P(X_1, X_2, \dots, X_m / Y = v_i)$ most likely

This is a Maximum Likelihood classifier.

It can get silly if some Y s are very unlikely

$$Y^{\text{predict}} = \underset{v}{\operatorname{argmax}} P(X_1 = u_1 \cdots X_m = u_m | Y = v)$$

Is this a good idea?

Copyright © Andrew W. Moore

Slide 95

How to build a Bayes Classifier

- Assume you want to predict output Y which has arity n_y and values V_1, V_2, \dots, V_{n_y}
- Assume there are m input attributes called X_1, X_2, \dots, X_m
- Break dataset into n_y smaller datasets called DS_i
- Define $DS_i =$ Records in which $Y = v_i$
- For each DS_i , learn Density Estimator M_i distribution among the $Y = v_i$ records.
- M_i estimates $P(X_1, X_2, \dots, X_m / Y = v_i)$
- Idea: When a new set of input values $(X_1 = u_1, X_2 = u_2, \dots, X_m = u_m)$ come along to be evaluated predict the value of Y that makes $P(Y = v_i / X_1, X_2, \dots, X_m)$ most likely

Much Better Idea

$$Y^{\text{predict}} = \underset{v}{\operatorname{argmax}} P(Y = v | X_1 = u_1 \cdots X_m = u_m)$$

Is **this** a good idea?

Copyright © Andrew W. Moore

Slide 96

Terminology

- MLE (Maximum Likelihood Estimator):

$$Y^{\text{predict}} = \underset{v}{\operatorname{argmax}} P(X_1 = u_1 \cdots X_m = u_m | Y = v)$$

- MAP (Maximum A-Posteriori Estimator):

$$Y^{\text{predict}} = \underset{v}{\operatorname{argmax}} P(Y = v | X_1 = u_1 \cdots X_m = u_m)$$

Copyright © Andrew W. Moore

Slide 97

Getting what we need

$$Y^{\text{predict}} = \underset{v}{\operatorname{argmax}} P(Y = v | X_1 = u_1 \cdots X_m = u_m)$$

Copyright © Andrew W. Moore

Slide 98

Getting a posterior probability

$$\begin{aligned} & P(Y = v | X_1 = u_1 \cdots X_m = u_m) \\ = & \frac{P(X_1 = u_1 \cdots X_m = u_m | Y = v)P(Y = v)}{P(X_1 = u_1 \cdots X_m = u_m)} \\ = & \frac{P(X_1 = u_1 \cdots X_m = u_m | Y = v)P(Y = v)}{\sum_{j=1}^{n_Y} P(X_1 = u_1 \cdots X_m = u_m | Y = v_j)P(Y = v_j)} \end{aligned}$$

Copyright © Andrew W. Moore

Slide 99

Bayes Classifiers in a nutshell

1. Learn the distribution over inputs for each value Y .
2. This gives $P(X_1, X_2, \dots, X_m | Y=v_j)$.
3. Estimate $P(Y=v_j)$ as fraction of records with $Y=v_j$.
4. For a new prediction:

$$\begin{aligned} Y^{\text{predict}} &= \underset{v}{\operatorname{argmax}} P(Y = v | X_1 = u_1 \cdots X_m = u_m) \\ &= \underset{v}{\operatorname{argmax}} P(X_1 = u_1 \cdots X_m = u_m | Y = v)P(Y = v) \end{aligned}$$

Copyright © Andrew W. Moore

Slide 100

Bayes Classifiers in a nutshell

1. Learn the distribution over inputs for each value Y .
2. This gives $P(X_1, X_2, \dots, X_m / Y=v_j)$.
3. Estimate $P(Y=v_j)$ as fraction of records with $Y=v_j$.
4. For a new prediction:

$$Y^{\text{predict}} = \underset{v}{\operatorname{argmax}} P(Y = v | X_1 = u_1 \cdots X_m = u_m)$$

$$= \underset{v}{\operatorname{argmax}} P(X_1 = u_1 \cdots X_m = u_m | Y = v) P(Y = v)$$

We can use our favorite Density Estimator here.

Right now we have two options:

- Joint Density Estimator
- Naïve Density Estimator

Copyright © Andrew W. Moore

Slide 101

Joint Density Bayes Classifier

$$Y^{\text{predict}} = \underset{v}{\operatorname{argmax}} P(X_1 = u_1 \cdots X_m = u_m | Y = v) P(Y = v)$$

In the case of the joint Bayes Classifier this degenerates to a very simple rule:

Y^{predict} = the most common value of Y among records in which $X_1 = u_1, X_2 = u_2, \dots, X_m = u_m$.

Note that if no records have the exact set of inputs $X_1 = u_1, X_2 = u_2, \dots, X_m = u_m$, then $P(X_1, X_2, \dots, X_m / Y=v_j) = 0$ for all values of Y .

In that case we just have to guess Y 's value

Copyright © Andrew W. Moore

Slide 102

Joint BC Results: "Logical"

The "logical" dataset consists of 40,000 records and 4 Boolean attributes called a,b,c,d where a,b,c are generated 50-50 randomly as 0 or 1. $D = A \wedge \sim C$, except that in 10% of records it is flipped

d = 0 (prior = 0.69945)				d = 1 (prior = 0.30055)			
a	b	c		a	b	c	
0	0	0	0.162056	0	0	0	0.0425886
1	0	0	0.162378	1	0	0	0.0407586
1	0	1	0.16152	1	0	1	0.04001
1	1	0	0.158982	1	1	0	0.0404259
1	0	0	0.017621	1	0	0	0.374314
1	1	1	0.159232	1	1	1	0.0408418
1	0	1	0.017621	1	0	1	0.377142
1	1	1	0.16059	1	1	1	0.0439195

The Classifier learned by "Joint BC"

Name	Model	Parameters	FracRight
Model1	bayesclass	density=joint submodel=gauss gausstype=general	0.90065 +/- 0.00301897

Copyright © Andrew W. Moore

Slide 103

Joint BC Results: "All Irrelevant"

The "all irrelevant" dataset consists of 40,000 records and 15 Boolean attributes called a,b,c,d..o where a,b,c are generated 50-50 randomly as 0 or 1. $v(\text{output}) = 1$ with probability 0.75, 0 with prob 0.25

Name	Model	Parameters	FracRight
Model1	bayesclass	density=joint submodel=gauss gausstype=general	0.70425 +/- 0.00583537

Copyright © Andrew W. Moore

Slide 104

Naïve Bayes Classifier

$$Y^{\text{predict}} = \underset{v}{\operatorname{argmax}} P(X_1 = u_1 \cdots X_m = u_m | Y = v)P(Y = v)$$

In the case of the naive Bayes Classifier this can be simplified:

$$Y^{\text{predict}} = \underset{v}{\operatorname{argmax}} P(Y = v) \prod_{j=1}^{n_y} P(X_j = u_j | Y = v)$$

Copyright © Andrew W. Moore

Slide 105

Naïve Bayes Classifier

$$Y^{\text{predict}} = \underset{v}{\operatorname{argmax}} P(X_1 = u_1 \cdots X_m = u_m | Y = v)P(Y = v)$$

In the case of the naive Bayes Classifier this can be simplified:

$$Y^{\text{predict}} = \underset{v}{\operatorname{argmax}} P(Y = v) \prod_{j=1}^{n_y} P(X_j = u_j | Y = v)$$

Technical Hint:

If you have 10,000 input attributes **that** product will underflow in floating point math. You should use logs:

$$Y^{\text{predict}} = \underset{v}{\operatorname{argmax}} \left(\log P(Y = v) + \sum_{j=1}^{n_y} \log P(X_j = u_j | Y = v) \right)$$

Copyright © Andrew W. Moore

Slide 106

BC Results: "XOR"

The "XOR" dataset consists of 40,000 records and 2 Boolean inputs called a and b, generated 50-50 randomly as 0 or 1. c (output) = $a \text{ XOR } b$

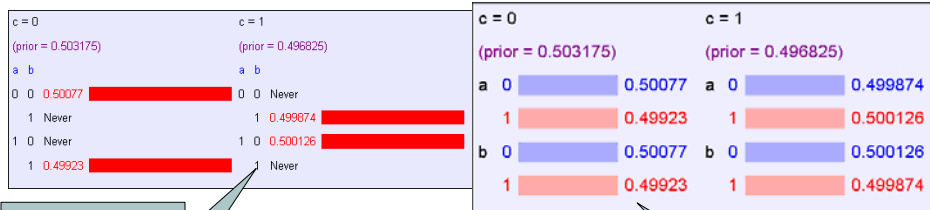

The Classifier learned by "Joint BC"

The Classifier learned by "Naive BC"

Model	Name	Model	Parameters	FracRight	
Model1	bayesclass	density=joint	submodel=gauss	gausstype=general	1 +/- 0
Model2	bayesclass	density=naive	submodel=gauss	gausstype=general	0.500126 +/- 0.00529626

Copyright © Andrew W. Moore

Slide 107

Naive BC Results: "Logical"

The "logical" dataset consists of 40,000 records and 4 Boolean attributes called a,b,c,d where a,b,c are generated 50-50 randomly as 0 or 1. $D = A \wedge \sim C$, except that in 10% of records it is flipped

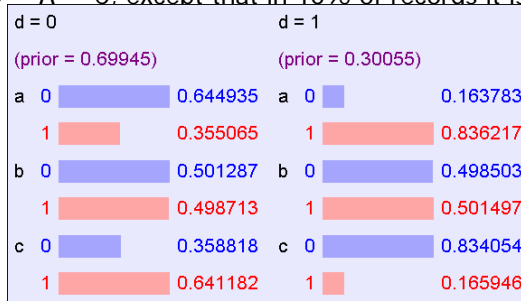

The Classifier learned by "Naive BC"

Name	Model	Parameters	FracRight		
Model1	bayesclass	density=joint	submodel=gauss	gausstype=general	0.90065 +/- 0.00301897
Model2	bayesclass	density=naive	submodel=gauss	gausstype=general	0.90065 +/- 0.00301897

Copyright © Andrew W. Moore

Slide 108

Naive BC Results: "Logical"

The "logical" dataset consists of 40,000 records and 4 Boolean attributes called a,b,c,d where a,b,c are generated 50-50 randomly as 0 or 1. $D = A \wedge \sim C$, except that in 10% of records it is flipped

This result surprised Andrew until he had thought about it a little

d values: 0 1

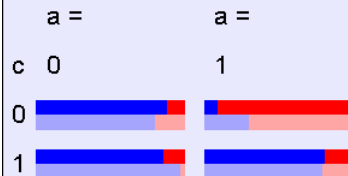

The data shown in the figure is merely a subsample of the full dataset. The light color shades denote predicted classes. The dark shades are real data.

Name	Model	Parameters	FracRight
Model1	bayesclass	density=joint submodel=gauss gausstype=general	0.90065 +/- 0.00301897
Model2	bayesclass	density=naive submodel=gauss gausstype=general	0.90065 +/- 0.00301897

Copyright © Andrew W. Moore

Slide 109

Naive BC Results: "All Irrelevant"

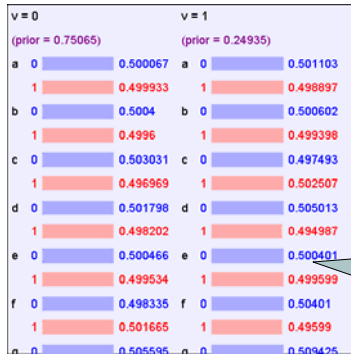

The Classifier learned by "Naive BC"

The "all irrelevant" dataset consists of 40,000 records and 15 Boolean attributes called a,b,c,d..o where a,b,c are generated 50-50 randomly as 0 or 1. v (output) = 1 with probability 0.75, 0 with prob 0.25

Name	Model	Parameters	FracRight
Model1	bayesclass	density=joint submodel=gauss gausstype=general	0.70425 +/- 0.00583537
Model2	bayesclass	density=naive submodel=gauss gausstype=general	0.75065 +/- 0.00281976

Copyright © Andrew W. Moore

Slide 110

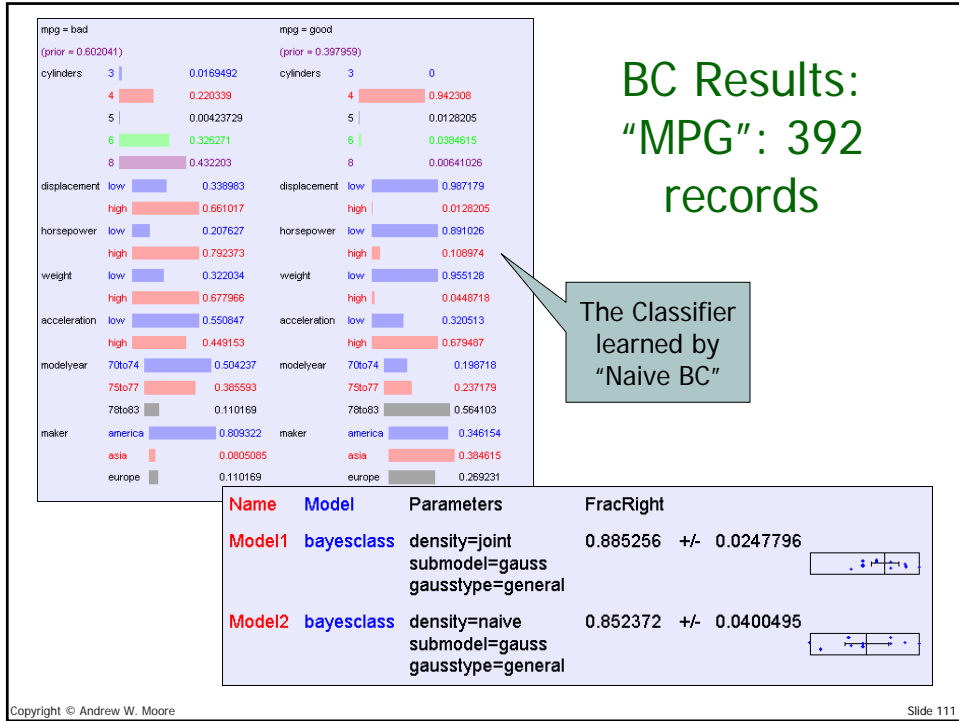

Copyright © Andrew W. Moore

Slide 111

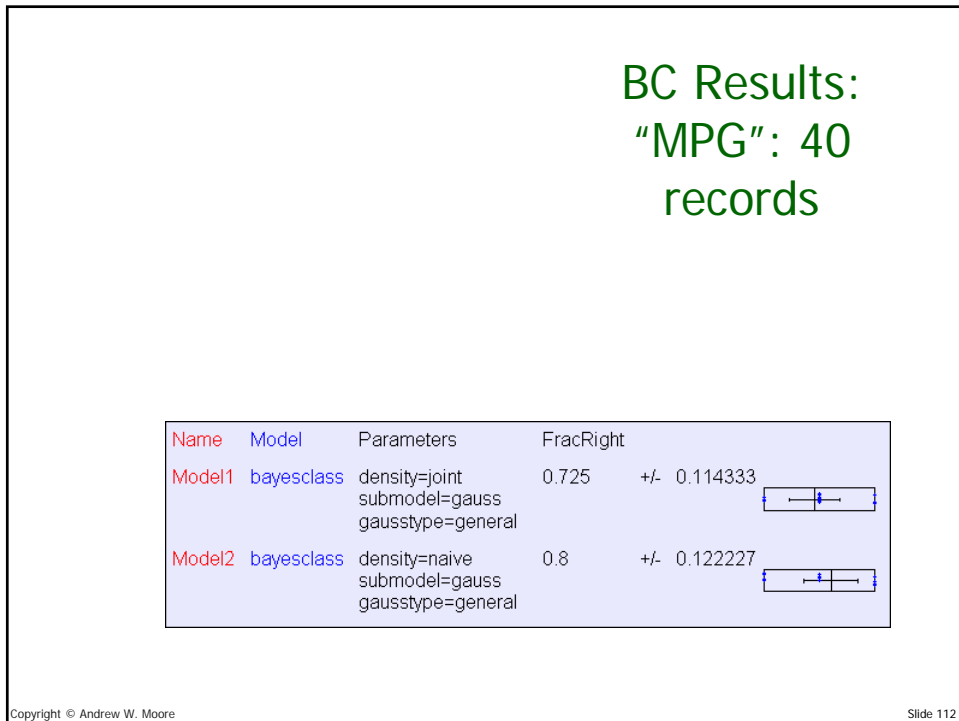

Copyright © Andrew W. Moore

Slide 112

More Facts About Bayes Classifiers

- Many other density estimators can be slotted in*.
- Density estimation can be performed with real-valued inputs*
- Bayes Classifiers can be built with real-valued inputs*
- Rather Technical Complaint: Bayes Classifiers don't try to be maximally discriminative---they merely try to honestly model what's going on*
- Zero probabilities are painful for Joint and Naïve. A hack (justifiable with the magic words "Dirichlet Prior") can help*.
- Naïve Bayes is wonderfully cheap. And survives 10,000 attributes cheerfully!

*See future Andrew Lectures

Copyright © Andrew W. Moore

Slide 113

What you should know

- Probability
 - Fundamentals of Probability and Bayes Rule
 - What's a Joint Distribution
 - How to do inference (i.e. $P(E1|E2)$) once you have a JD
- Density Estimation
 - What is DE and what is it good for
 - How to learn a Joint DE
 - How to learn a naïve DE

Copyright © Andrew W. Moore

Slide 114

What you should know

- Bayes Classifiers
 - How to build one
 - How to predict with a BC
 - Contrast between naïve and joint BCs

Copyright © Andrew W. Moore

Slide 115

Interesting Questions

- Suppose you were evaluating NaiveBC, JointBC, and Decision Trees
 - Invent a problem where only NaiveBC would do well
 - Invent a problem where only Dtree would do well
 - Invent a problem where only JointBC would do well
 - Invent a problem where only NaiveBC would do poorly
 - Invent a problem where only Dtree would do poorly
 - Invent a problem where only JointBC would do poorly

Copyright © Andrew W. Moore

Slide 116