

DENSO ROBOT

Vertical articulated
V*-D/-E SERIES

BEGINNER'S GUIDE

Copyright © DENSO WAVE INCORPORATED, 2001

All rights reserved. No part of this publication may be reproduced in any form or by any means without permission in writing from the publisher.

Specifications are subject to change without prior notice.

All products and company names mentioned are trademarks or registered trademarks of their respective holders

Preface

Thank you for purchasing this high-speed, high-accuracy assembly robot.

Before operating your robot, read this manual carefully to safely get the maximum benefit from your robot in your assembling operations.

Robot series and/or models covered by this manual

Vertical articulated, V*-D, E SERIES robot

Important

To ensure operator safety, be sure to read the precautions and instructions in "SAFETY PRECAUTIONS," pages 1 through 9.

How the V*-D, E documentation set is organized

The V*-D, E documentation set consists of the following six books. If you are unfamiliar with this robot series, please read all six books and understand them fully before operating your robot.

BEGINNER'S GUIDE - this book -

Introduces you to the DENSO robot. Taking an equipment setup example, this book guides you through running your robot with the teach pendant, making a program in WINCAPSII, and running your robot automatically.

INSTALLATION & MAINTENANCE GUIDE

Provides an explanation of the robot outline, instructions for installing the robot components, and maintenance & inspection procedures.

SETTING-UP MANUAL

Describes how to set-up or teach your robot with the teach pendant, mini pendant or operating panel.

WINCAPSII GUIDE (that comes with WINCAPSII)

Provides instructions on how to use the teaching system installed on the PC, connected to the robot and its controller, for developing and managing programs.

PROGRAMMER'S MANUAL

Describes the PAC programming language, steps to develop programs in PAC, and command specifications.

ERROR CODE TABLES

List error codes that will appear on the teach pendant, operating panel, mini pendant or PC screen if an error occurs in the robot series or WINCAPSII. These tables provide detailed description and recovery ways.

How this book is organized

This book is just one part of the V*-D documentation set. This book consists of SAFETY PRECAUTIONS, parts one through five, and appendices.

SAFETY PRECAUTIONS

Defines safety terms, safety related symbols and provides precautions that should be observed. Be sure to read this section before operating your robot.

Part 1 Running the Robot with the Teach Pendant

Describes how to run the robot with the teach pendant in manual mode, how to create a simple program with the teach pendant, and how to teach the robot.

Part 2 Creating a Program on a PC in WINCAPSII

Provides instructions for setting up WINCAPSII on a PC, creating and compiling a program, and uploading the compiled program to the robot controller.

It also describes machine lock which is required for simulations to be performed in Part 3.

Part 3 Simulating the Robot Motion on a PC according to the Program

Describes how to check the programmed operation by using the simulator on a PC.

Part 4 Running the Robot Using Programs

Provides procedures for running your robot actually according to programs and describes palletizing which is one of the main applications on robots. It also describes how to make use of PAC libraries which greatly improve the efficiency of task program development.

Part 5 Features of DENSO Robots

Describes compliance controls and other functions of the DENSO robots.

Appendices

Appendix-1 Glossary

Appendix-2 Names of the robot controller parts



Appendix-3 Names of the teach pendant parts

Appendix-4 Menu tree on the teach pendant

SAFETY PRECAUTIONS

Be sure to observe all of the following safety precautions.

Strict observance of these warning and caution indications are a **MUST** for preventing accidents, which could result in bodily injury and substantial property damage. Make sure you fully understand all definitions of these terms and related symbols given below, before you proceed to the text itself.

 WARNING	Alerts you to those conditions, which could result in serious bodily injury or death if the instructions are not followed correctly.
 CAUTION	Alerts you to those conditions, which could result in minor bodily injury or substantial property damage if the instructions are not followed correctly.

Terminology and Definitions

Maximum space: Refers to the volume of space encompassing the maximum designed movements of all robot parts including the end-effector, workpiece and attachments. (Quoted from the RIA* Committee Draft.)

Restricted space: Refers to the portion of the maximum space to which a robot is restricted by limiting devices (i.e., mechanical stops). The maximum distance that the robot, end-effector, and workpiece can travel after the limiting device is actuated defines the boundaries of the restricted space of the robot. (Quoted from the RIA Committee Draft.)

Motion space: Refers to the portion of the restricted space to which a robot is restricted by software motion limits. The maximum distance that the robot, end-effector, and workpiece can travel after the software motion limits are set defines the boundaries of the motion space of the robot. (The "motion space" is Denso-proprietary terminology.)

Operating space: Refers to the portion of the restricted space (or motion space in Denso) that is actually used by the robot while performing its task program. (Quoted from the RIA Committee Draft.)

Task program: Refers to a set of instructions for motion and auxiliary functions that define the specific intended task of the robot system. (Quoted from the RIA Committee Draft.)

(*RIA: Robotic Industries Association)

1. Introduction

This section provides safety precautions to be observed during installation, teaching, inspection, adjustment, and maintenance of the robot.

2. Installation Precautions

2.1 Insuring the proper installation environment

2.1.1 For standard type

The standard type has not been designed to withstand explosions, dust-proof, nor is it splash-proof. Therefore, it should not be installed in any environment where:

- (1) there are flammable gases or liquids,
- (2) there are any shavings from metal processing or other conductive material flying about,
- (3) there are any acidic, alkaline or other corrosive gases,
- (4) there is cutting or grinding oil mist,
- (5) it may likely be submerged in fluid,
- (6) there is sulfuric cutting or grinding oil mist, or
- (7) there are any large-sized inverters, high output/high frequency transmitters, large contactors, welders, or other sources of electrical noise.

2.1.2 For dust-proof, splash-proof type

The dust-proof, splash-proof type is an IP54-equivalent dust-proof and splash-proof structure, but it has not been designed to withstand explosions. (The wrist of the VM-D-W or VS-E-W is an IP65-equivalent dust-proof and splash-proof structure.)

Note that the robot controller is not a dust- or splash-proof structure. Therefore, when using the robot controller in an environment exposed to mist, put it in an optional protective box.

The dust-proof, splash-proof type should not be installed in any environment where:

- (1) there are any flammable gases or liquids,
- (2) there are any acidic, alkaline or other corrosive gases,
- (3) there are any large-sized inverters, high output/high frequency transmitters, large contactors, welders, or other sources of electrical noise,
- (4) it may likely be submerged in fluid,
- (5) there are any grinding or machining chips or shavings,
- (6) any machining oil other than DENSO authorized oil is in use, or

Note: DENSO authorized oil: Yushiron Oil No. 4C (non-soluble)

- (7) there is sulfuric cutting or grinding oil mist.

2.2 Service space

The robot and peripheral equipment should be installed so that sufficient service space is maintained for safe teaching, maintenance, and inspection.

- 2.3 Control devices outside the robot's restricted space** The robot controller, teach pendant, and operating panel should be installed outside the robot's restricted space and in a place where you can observe all of the robot's movements when operating the robot controller, teach pendant, or operating panel.
- 2.4 Positioning of gauges** Pressure gauges, oil pressure gauges and other gauges should be installed in an easy-to-check location.
- 2.5 Protection of electrical wiring and hydraulic/pneumatic piping** If there is any possibility of the electrical wiring or hydraulic/pneumatic piping being damaged, protect them with a cover or similar item.
- 2.6 Positioning of emergency stop switches** Emergency stop switches should be provided in a position where they can be reached easily should it be necessary to stop the robot immediately.
- (1) The emergency stop switches should be red.
 - (2) Emergency stop switches should be designed so that they will not be released after pressed, automatically or mistakenly by any other person.
 - (3) Emergency stop switches should be separate from the power switch.
- 2.7 Positioning of operating status indicators** Operating status indicators should be positioned in such a way where workers can easily see whether the robot is on temporary halt or on an emergency or abnormal stop.

2.8 Setting-up the safety fence or enclosure

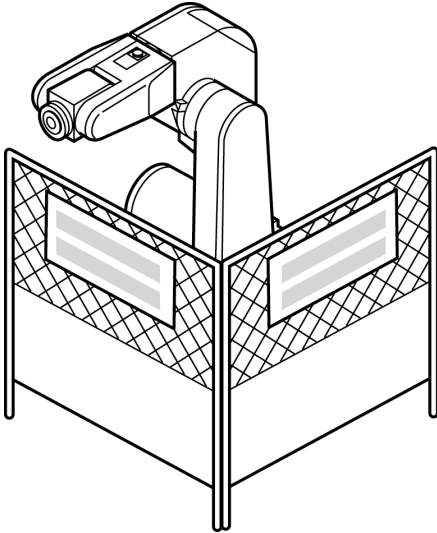

A safety fence or enclosure should be set up so that no one can easily enter the robot's restricted space. If it is impossible, utilize other protectors as described in Section 2.9.

- (1) The fence or enclosure should be constructed so that it cannot be easily moved or removed.
- (2) The fence or enclosure should be constructed so that it cannot be easily damaged or deformed through external force.
- (3) Establish the exit/entrance to the fence or enclosure. Construct the fence or enclosure so that no one can easily get past it by climbing over the fence or enclosure.
- (4) The fence or enclosure should be constructed to ensure that it is not possible for hands or any other parts of the body to get through it.
- (5) Take any one of the following protections for the entrance/exit of the fence or enclosure:
 - 1) Place a door, rope or chain across the entrance/exit of the fence or enclosure, and fit it with an interlock that ensures the emergency stop device operates automatically if it is opened or removed.
 - 2) Post a warning notice at the entrance/exit of the fence or enclosure stating "In operation--Entry forbidden" or "Work in progress--Do not operate" and ensure that workers follow these instructions at all times.

When making a test run, before setting up the fence or enclosure, place an overseer in a position outside the robot's restricted space and one in which he/she can see all of the robot's movements. The overseer should prevent workers from entering the robot's restricted space and be devoted solely to that task.

2.9 Positioning of rope or chain

If it is not possible to set up the safety fence or enclosure described in Section 2.8, hang a rope or chain around the perimeter of the robot's restricted space to ensure that no one can enter the restricted space.

- (1) Ensure the support posts cannot be moved easily.
- (2) Ensure that the rope or chain's color or material can easily be discerned from the surrounds.
- (3) Post a warning notice in a position where it is easy to see stating "In operation--Entry forbidden" or "Work in progress --Do not operate" and ensure that workers follow these instructions at all times.
- (4) Set the exit/entrance, and follow the instructions given in Section 2.8, (3) through (5).

2.10 Setting the robot's motion space

The area required for the robot to work is called the robot's operating space.

If the robot's motion space is greater than the operating space, it is recommended that you set a smaller motion space to prevent the robot from interfering or disrupting other equipment.

Refer to the "INSTALLATION & MAINTENANCE GUIDE" Chapter 4.

2.11 No robot modification allowed

Never modify the robot unit, robot controller, teach pendant or other devices.

2.12 Cleaning of tools

If your robot uses welding guns, paint spray nozzles, or other end-effectors requiring cleaning, it is recommended that the cleaning process be carried out automatically.

2.13 Lighting

Sufficient illumination should be assured for safe robot operation.

2.14 Protection from objects thrown by the end-effector

If there is any risk of workers being injured in the event that the object being held by the end-effector is dropped or thrown by the end-effector, consider the size, weight, temperature and chemical nature of the object and take appropriate safeguards to ensure safety.

2.15 Affixing the warning label

Place the warning label packaged with the robot on the exit/entrance of the safety fence or in a position where it is easy to see.

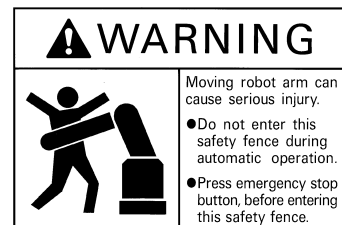

3. Precautions while robot is running



Warning

Touching the robot while it is in operation can lead to serious injury. Please ensure the following conditions are maintained and that the cautions listed from Section 3.1 onwards are followed when any work is being performed.

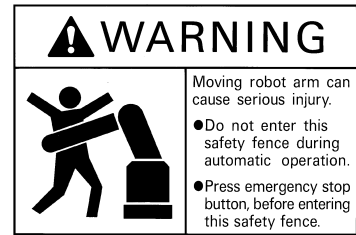

- 1) Do not enter the robot's restricted space when the robot is in operation or when the motor power is on.
- 2) As a precaution against malfunction, ensure that an emergency stop device is activated to cut the power to the robot motor upon entry into the robot's restricted space.
- 3) When it is necessary to enter the robot's restricted space to perform teaching or maintenance work while the robot is running, ensure that the steps described in Section 3.3 "Ensuring safety of workers performing jobs within the robot's restricted space" are taken.

3.1 Creation of working regulations and assuring worker adherence

When entering the robot's restricted space to perform teaching or maintenance inspections, set "working regulations" for the following items and ensure workers adhere to them.

- (1) Operating procedures required to run the robot.
- (2) Robot speed when performing teaching.
- (3) Signaling methods to be used when more than one worker is to perform work.
- (4) Steps that must be taken by the worker in the event of a malfunction, according to the contents of the malfunction.
- (5) The necessary steps for checking release and safety of the malfunction status, in order to restart the robot after robot movement has been stopped due to activation of the emergency stop device
- (6) Apart from the above, any steps below necessary to prevent danger from unexpected robot movement or malfunction of the robot.
 - 1) Display of the control panel (See Section 3.2 on the following page)
 - 2) Assuring the safety of workers performing jobs within the robot's restricted space (See Section 3.3 on the following page)
 - 3) Maintaining worker position and stance

Position and stance that enables the worker to confirm normal robot operation and to take immediate refuge if a malfunction occurs.

- 4) Implementation of measures for noise prevention
- 5) Signaling methods for workers of related equipment
- 6) Types of malfunctions and how to distinguish them

Please ensure "working regulations" are appropriate to the robot type, the place of installation and to the content of the work.

Be sure to consult the opinions of related workers, engineers at the equipment manufacturer and that of a labor safety consultant when creating these "working regulations".

3.2 Display of operation panel

To prevent anyone other than the worker from accessing the start switch or the changeover switch by accident during operation, display something to indicate it is in operation on the operating panel or teach pendant. Take any other steps as appropriate, such as locking the cover.

3.3 Ensuring safety of workers performing jobs within the robot's restricted space

When performing jobs within the robot's restricted space, take any of the following steps to ensure that robot operation can be stopped immediately upon a malfunction.

- (1) Ensure an overseer is placed in a position outside the robot's restricted space and one in which he/she can see all robot movements, and that he/she is devoted solely to that task.
 - ① An emergency stop device should be activated immediately upon a malfunction.
 - ② Do not permit anyone other than the worker engaged for that job to enter the robot's restricted space.
- (2) Ensure a worker within the robot's restricted space carries the portable emergency stop switch so he/she can press it (the robot stop button on the teach pendant) immediately if it should be necessary to do so.

3.4 Inspections before commencing work such as teaching

Before starting work such as teaching, inspect the following items, carry out any repairs immediately upon detection of a malfunction and perform any other necessary measures.

- (1) Check for any damage to the sheath or cover of the external wiring or to the external devices.
- (2) Check that the robot is functioning normally or not (any unusual noise or vibration during operation).
- (3) Check the functioning of the emergency stop device.
- (4) Check there is no leakage of air or oil from any pipes.
- (5) Check there are no obstructive objects in or near the robot's restricted space.

3.5 Release of residual air pressure

Before disassembling or replacing pneumatic parts, first release any residual air pressure in the drive cylinder.

3.6 Precautions for test runs

Whenever possible, have the worker stay outside of the robot's restricted space when performing test runs.

3.7 Precautions for automatic operation

(1) At start-up

Before the robot is to be started up, first check the following items as well as setting the signals to be used and perform signaling practice with all related workers.

- 1) Check that there is no one inside the robot's restricted space.
 - 2) Check that the teach pendant and tools are in their designated places.
 - 3) Check that no lamps indicating a malfunction on the robot or related equipment are lit.
- (2) Check that the display lamp indicating automatic operation is lit during automatic operation.

(3) Steps to be taken when a malfunction occurs

Should a malfunction occur with the robot or related equipment and it is necessary to enter the robot's restricted space to perform emergency maintenance, stop the robot's operation by activating the emergency stop device. Take any necessary steps such as placing a display on the starter switch to indicate work is in progress to prevent anyone from accessing the robot.

3.8 Precautions in repairs

- (1) Do not perform repairs outside of the designated range.
- (2) Under no circumstances should the interlock mechanism be removed.
- (3) When opening the robot controller's cover for battery replacement or any other reasons, always turn the robot controller power off and disconnect the power cable.
- (4) Use only spare tools authorized by DENSO.

4. Daily and periodical inspections

- (1) Be sure to perform daily and periodical inspections. Before starting jobs, always check that there is no problem with the robot and related equipment. If any problems are found, take any necessary measures to correct them.
- (2) When carrying out periodical inspections or any repairs, maintain records and keep them for at least 3 years.

5. Management of floppy disks

- (1) Carefully handle and store the "Initial settings" floppy disks packaged with the robot, which store special data exclusively prepared for your robot.
- (2) After finishing teaching or making any changes, always save the programs and data onto floppy disks.

Making back-ups will help you recover if data stored in the robot controller is lost due to the expired life of the back-up battery.
- (3) Write the names of each of the floppy disks used for storing task programs to prevent incorrect disks from loading into the robot controller.
- (4) Store the floppy disks where they will not be exposed to dust, humidity and magnetic field, which could corrupt the disks or data stored on them.



CONTENTS

Preface	i
How the V*-D, E documentation set is organized	ii
How this book is organized	iii
SAFETY PRECAUTIONS	1
Part 1 Running the Robot with the Teach Pendant	1
Lesson 1 Running the Robot in Manual Mode.....	3
1.1 Basic teach pendant operations	3
1.2 Running the robot manually with the teach pendant	5
Lesson 2 Running the Robot Using a Simple Program	14
2.1 Creating a simple program from the teach pendant.....	15
2.2 Teaching.....	24
2.3 Teach check.....	29
2.4 Running the robot in Auto mode	34
Part 2 Creating a Program on a PC in WINCAPSII	39
Lesson 3 Setting Up the Robot Controller with the Teach Pendant	40
3.1 Performing calibration (CAL).....	40
3.2 Placing the robot controller in machine lock.....	43
3.3 Setting the communications port of the robot controller.....	44
Lesson 4 Starting up WINCAPSII and Creating a System Project	48
4.1 Starting the System Manager	48
4.2 Registering a new system project.....	50
4.3 Setting the communications port of the PC.....	51
Lesson 5 Defining Macros	53
Lesson 6 Inputting and Editing Programs	55
6.1 Sample program	55
6.2 Opening the program edit window.....	56
6.3 Inputting program codes	57
6.4 Using the command builder	58
6.5 Saving the program	60
Lesson 7 Compiling the Program into Run-time Format	61
Lesson 8 Uploading the Program (PC → Robot controller).....	62
Part 3 Simulating the Robot Motion on a PC with the Program Created	65
Lesson 9 Preparing the PC for Simulation	67
9.1 Starting Arm Manager.....	67
9.2 Establishing the communications link with the robot controller in Arm Manager.....	67
Lesson 10 Assigning the Current Position Values to Position Variables	68
10.1 Simulating the robot motion manually.....	68
10.2 Getting the current position into a position variable	70
10.3 Editing position variables.....	76

Lesson 11 Test-running the Program	77
11.1 Loading the program	77
11.2 Starting the program.....	79
Lesson 12 Monitoring and Manipulating the I/Os.....	80
12.1 Starting the DIO Manager and establishing the communications link with the robot controller	80
12.2 Monitoring the I/Os.....	81
12.3 Turning the I/O dummy switches ON/OFF.....	82
Lesson 13 Monitoring and Manipulating Variables	83
13.1 Starting the Variable Manager and establishing the communications link with the robot controller....	83
13.2 Monitoring variables	84
Lesson 14 Continuous Run for Testing	85
14.1 Continuous run	85
14.2 Continuous monitoring of the I/Os.....	86
14.3 Stopping the running program.....	88
Part 4 Running the Robot Using Programs	89
Lesson 15 Running the Robot in Practice	90
15.1 Releasing machine lock.....	90
15.2 Setting robot speed and acceleration	91
15.3 Turning the drive motor ON.....	92
15.4 Teaching.....	93
15.5 Starting programs	96
15.6 Changing the robot speed.....	97
15.7 Stopping the robot in continuous running	98
Lesson 16 Palletizing	102
16.1 What is palletizing?.....	102
16.2 Simplified Palletizing.....	110
Lesson 17 Using Libraries Effectively	118
17.1 Program bank	119
17.2 Importing programs.....	121
Lesson 18 Terminating the Session	123
18.1 Terminating WINCAPSII and shutting down the PC	123
18.2 Turning the robot controller OFF.....	123
Part 5 Features of DENSO Robots.....	125
Lesson 19 Compliance Control	126
19.1 Current limit function for individual axes.....	126
19.2 Tip compliance function.....	127
Lesson 20 Other Features	128
Appendices	129
Appendix-1 Glossary.....	130
Appendix-2 Names of the robot controller parts	140
Appendix-3 Names of the teach pendant parts.....	142
Appendix-4 Menu tree of the teach pendant	144

Part 1

Running the Robot with the Teach Pendant

In Part 1, you will:

- Learn how to handle and operate the teach pendant.
- Practice the following with the teach pendant:
 - Performing safe and precise manual operation (in Joint, X-Y, and Tool modes)
 - Calibrating (CAL) the robot
 - Creating and editing programs
 - Performing safe teaching
 - Making a safe teach check
 - Starting up and stopping programs safely

▶ Lesson 1 Running the Robot in Manual Mode	3
1.1 Basic teach pendant operations	3
1.2 Running the robot manually with the teach pendant	5
▶ Lesson 2 Running the Robot Using a Simple Program	14
2.1 Creating a simple program from the teach pendant	15
2.2 Teaching	24
2.3 Teach check	29
2.4 Running the robot in Auto mode	34
■ Part 1 Practice Problems	38

Equipment Setup Example

The figure below shows an example of equipment setup with the robot included as part of the production line. This robot performs palletizing operations.

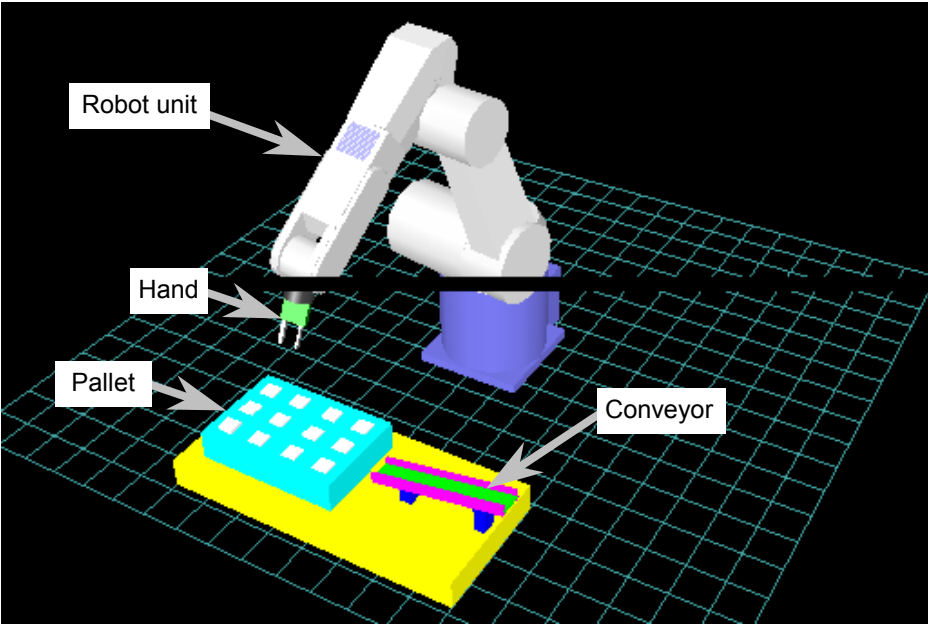

Process flow from program creation to checking of robot motion

Shown below is the process flow starting with program creation and continuing as far as checking of the robot motion.

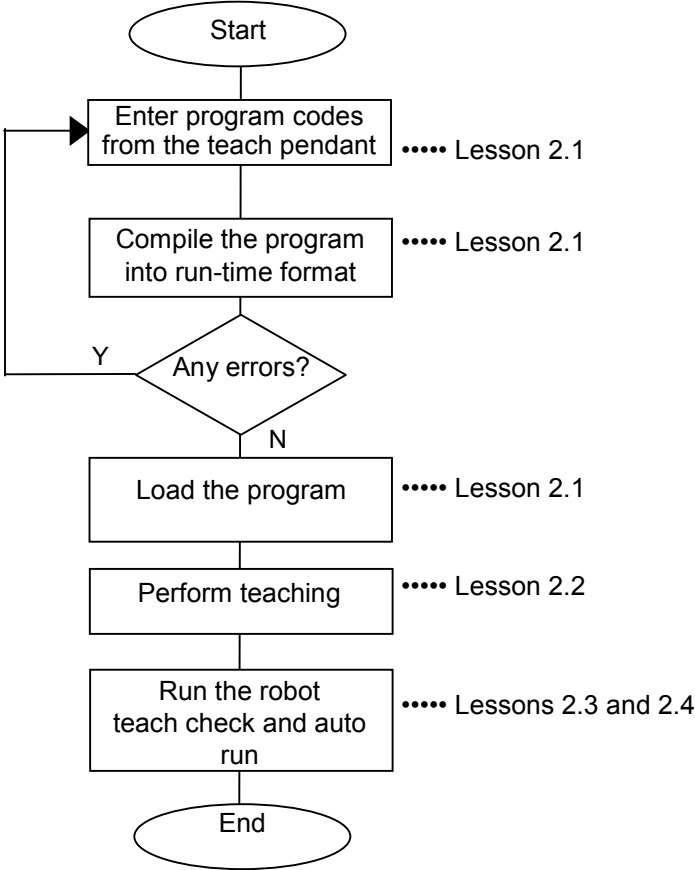

Lesson 1 Running the Robot in Manual Mode

1.1 Basic teach pendant operations

Holding the teach pendant and the deadman switch

When operating the teach pendant, grasp it as shown below.

The teach pendant has two deadman switches, so it is possible to hold the teach pendant in the following 2 ways:

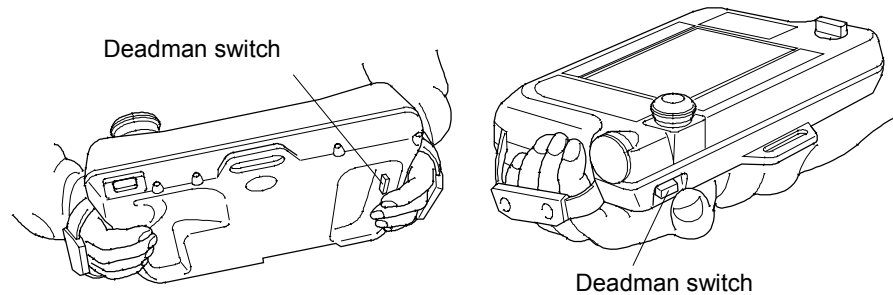

Holding the teach pendant

★Tip★

The deadman switch is provided to stop the robot automatically and safely when the operator can no longer operate the robot correctly due to unforeseen circumstances such as the operator suffering a blackout or dying while running the robot manually with the teach pendant. If a situation such as this arises, the strength with which the operator is pressing the deadman switch will either decrease or increase markedly. The deadman switch is a 3-position switch which is able to recognize and react to the following 3 operating statuses:

- 1) When the switch is not being pressed or is being pressed lightly
→ Switch: OFF
- 2) When the switch is being pressed with correct pressure
→ Switch: ON
- 3) When the switch is being pressed too strongly
→ Switch: OFF

Unless the switch is ON, the robot cannot run nor is it possible to drive the robot.

In order to ensure safety, the robot is designed so that in manual mode the deadman switch should be held down, for example, when the operator presses any of the arm traverse keys.

Basic make-up of the teach pendant

When the controller power is turned ON, the top screen shown below appears on the teach pendant.

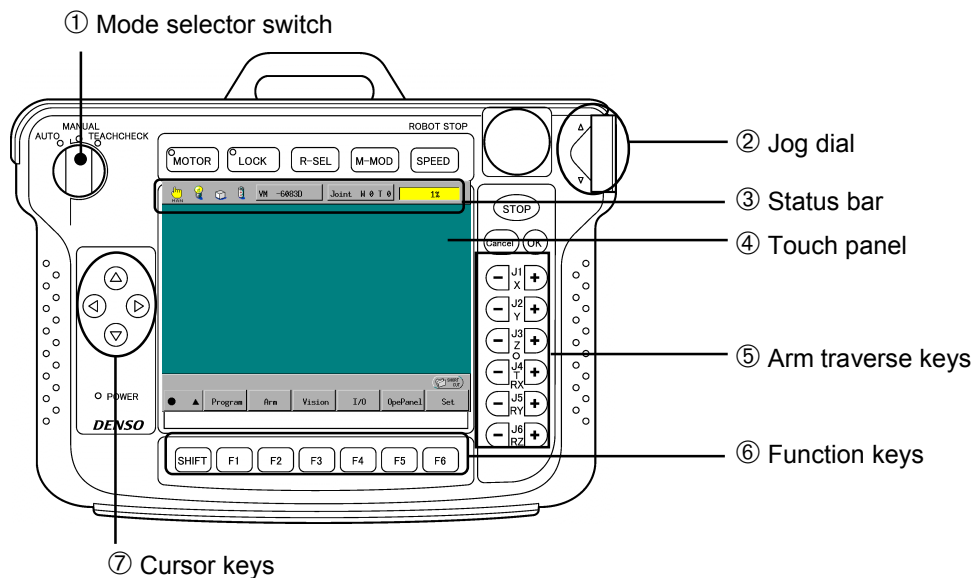

Teach pendant – top screen

① Mode selector switch

This switches operation modes between Auto, Manual and Teach check modes.

② Jog dial

This makes adjusting values easier.

③ Status bar

This always displays the current operation mode and robot status.

④ Touch panel

The LCD screen of the teach pendant is also a touch panel. By touching the buttons or data entry areas displayed on the screen, it is possible to perform operations and make selections.

Caution: Touch the LCD screen with your fingers only, never with the tip of a pen or any pointed object. Otherwise, the LCD will be damaged.

⑤ Arm traverse keys

These keys drive the robot arm manually in a designated direction. It is also necessary to hold down the deadman switch at the same time.

⑥ Function keys

F1 to F6 are normally displayed on the screen. This can be switched to display F7 to F12 when required by pressing the SHIFT key.

⑦ Cursor keys

These are used to move the cursor on the display screen and entry screen.

Refer to Appendix 3 for details on each section of the teach pendant.

1.2 Running the robot manually with the teach pendant

First of all, you will practice turning the robot controller and motor ON and running the robot manually with the teach pendant.

Step 1 Checking that it is safe to proceed

- Check that the robot is installed correctly.
- Check that there is no one within the robot's restricted space.

Step 2 Turning the robot controller ON

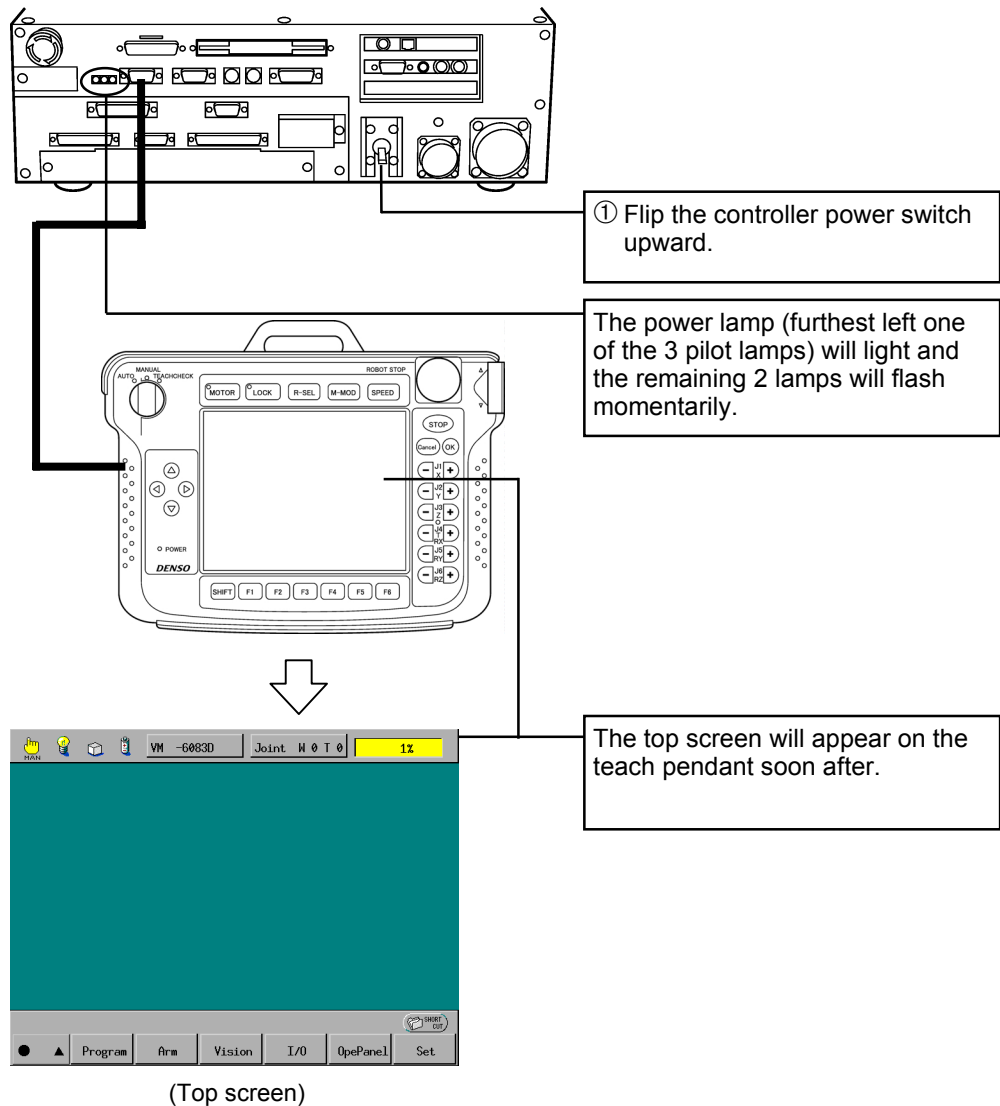

Step 3 Placing the robot in Manual mode

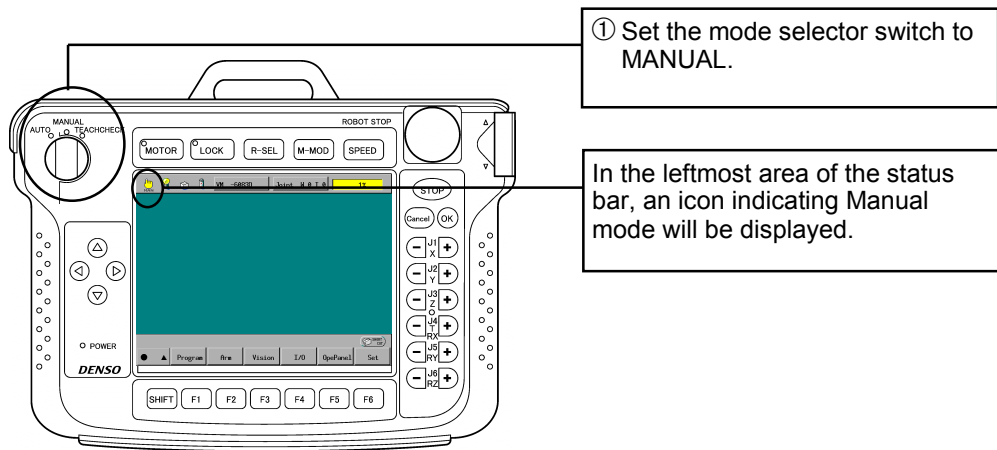

Step 4 Setting the speed and acceleration

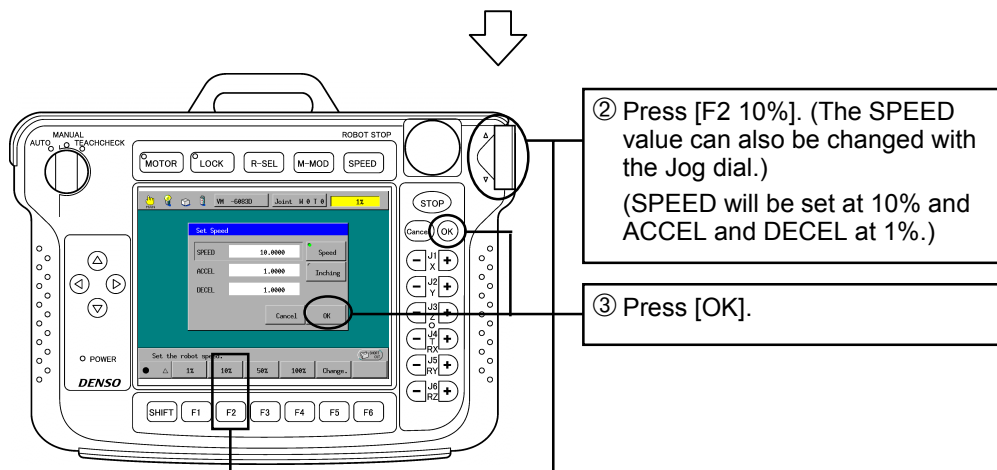
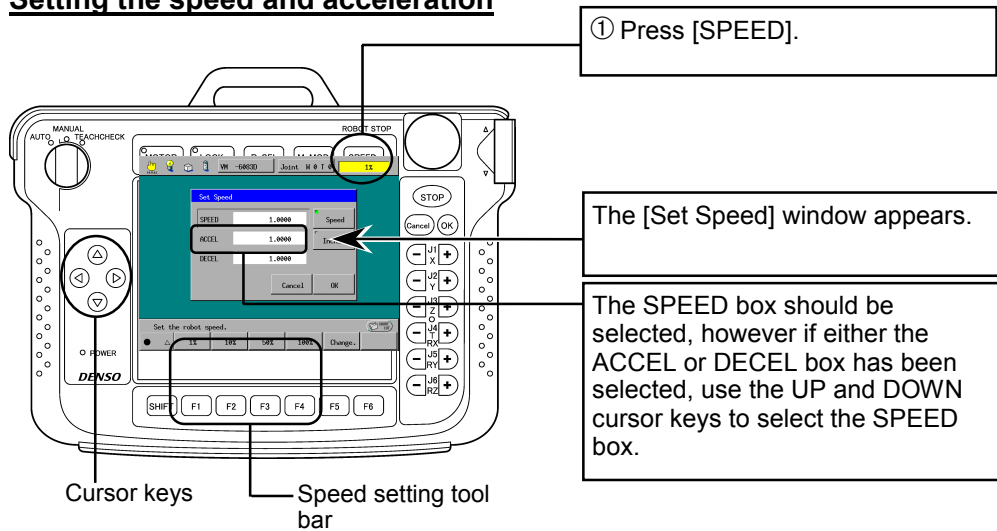

★Remarks★

At the beginning, leave these settings as they are, as you will be running the robot slowly to ensure safety. The settings can be changed later on, after you have become accustomed to running the robot with the teach pendant.

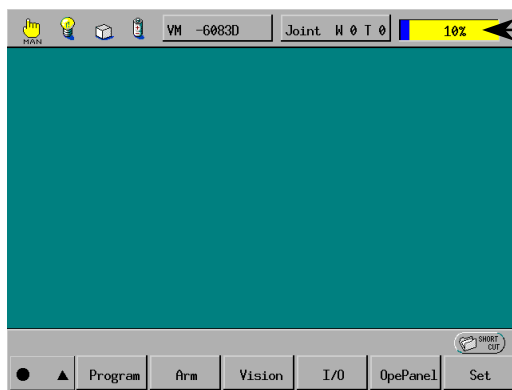

The SPEED display will become 10%.

Step 5

Turning the motor ON

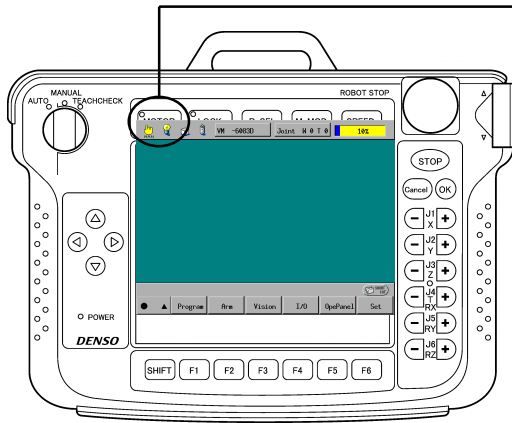

① Press [MOTOR].
The motor power is turned ON and the [MOTOR] lamp comes on.

Step 6

Moving each arm of the robot manually



Caution

When this operation is performed, the robot arm will move. Any workers should leave the robot's restricted space.

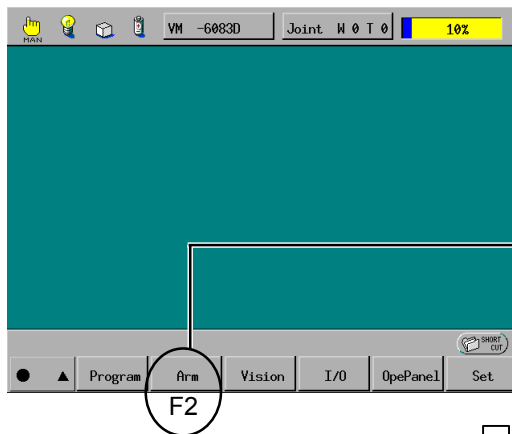

① Press [F2 Arm].

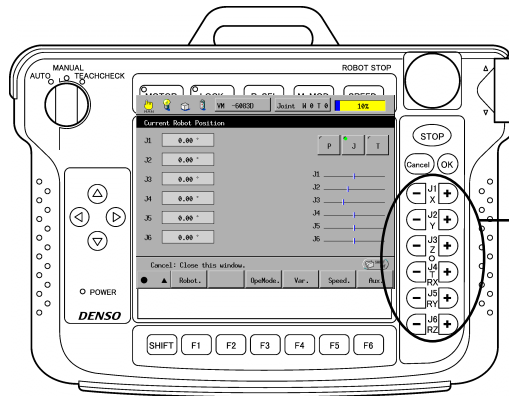

② While observing the robot, press the arm traverse keys with the deadman switch held down.

The arm corresponding with the operation of the J1 to J6 arm traverse keys will move. In the Current Robot Position window the angle of each axis will be displayed.

Caution: Until calibration (CAL) is performed, it is only possible to run the robot in Joint mode. Furthermore, the values shown for the coordinates for each of the axes are not accurate.

★**Caution**★

CAL is necessary to run the robot using accurate values.

Step 7

Performing CAL (calibration)

CAL stands for calibration, which actuates all robot axes to move the robot arm in small motions in order to confirm the current arm position after the controller power is turned ON.

The CAL procedure is described below.

! Caution

Performing CAL will move the robot arm. Before proceeding, be sure that all workers have left the robot's restricted space and that there are no obstacles in the robot's restricted space.

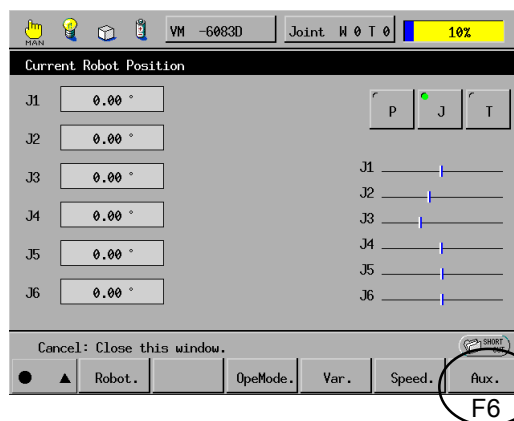

① Press [F6 Aux.] with the [Current Robot Position] window displayed.



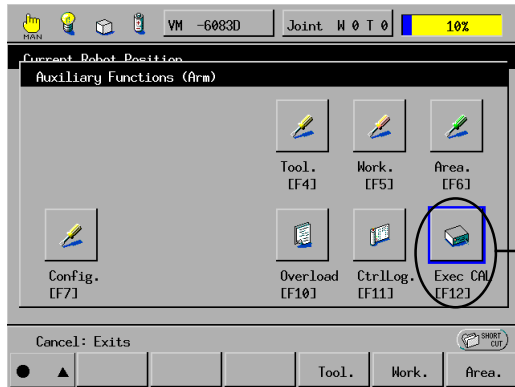

② Press [F12 Exec CAL].

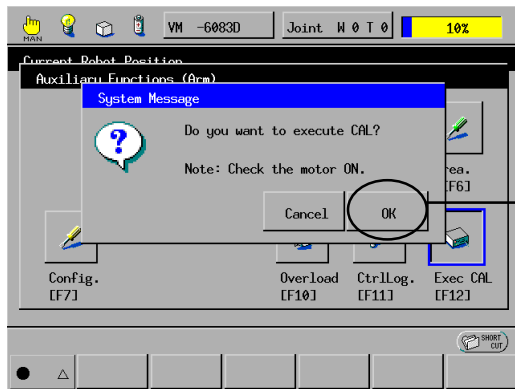

③ Check the System Message and press [OK].

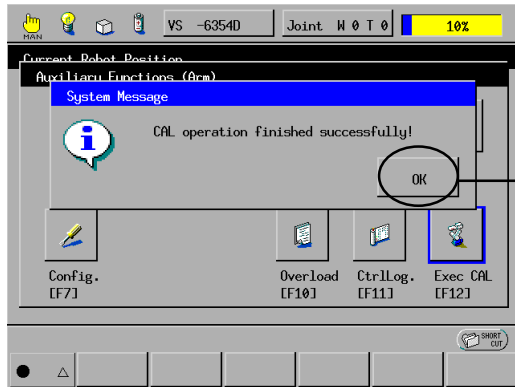

④ Check that the System Message reads "CAL operation finished successfully!" and press [OK].



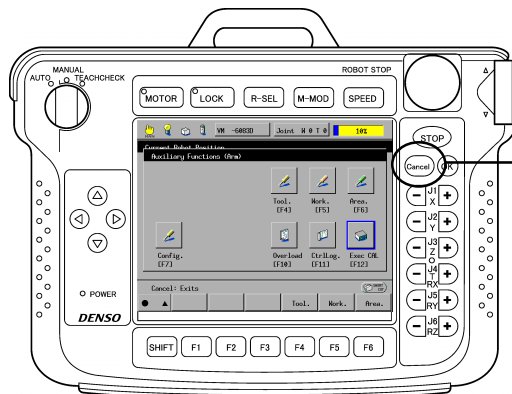

⑤ After returning to the [Auxiliary Functions (Arm)] window, press [Cancel].



The [Current Robot Position] window will be displayed again. At this point, CAL is completed and it is possible to run the robot.

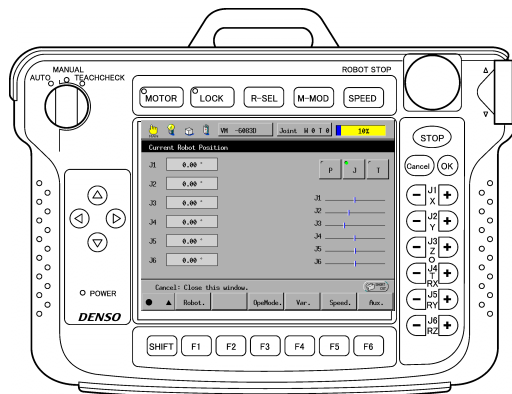

Step 8

Selecting Manual mode and running the robot manually

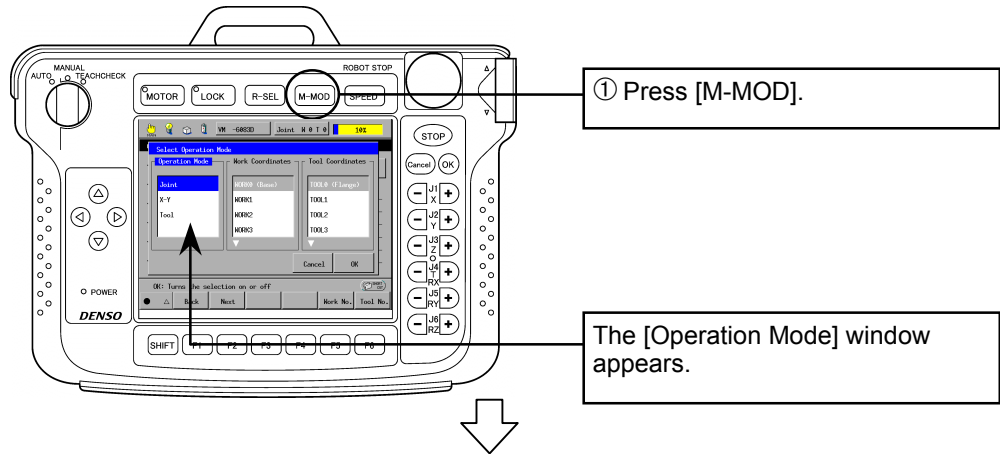

★Point★

In Manual mode, you may select any of these three modes: Joint mode, X-Y mode and Tool mode.

<Joint mode >

Allows you to drive each of the six joints independently.

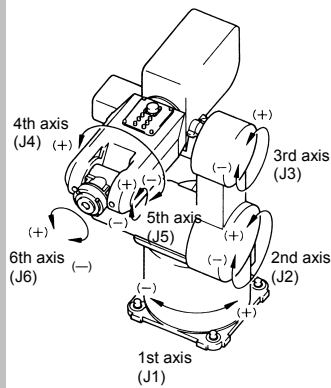

<X-Y mode>

Allows you to drive the robot flange linearly along the X, Y, or Z axis, respectively. If you use the RX, RY, or RZ key, the robot arm rotates on each axis of the virtual work coordinates defined on the center of the flange surface without changing the center position of the flange surface.

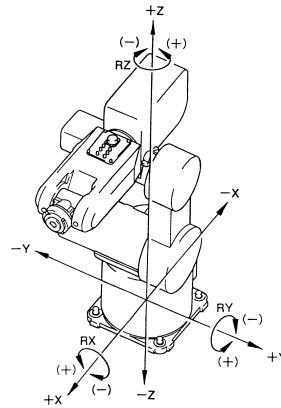

<Tool mode>

Allows you to drive the robot flange linearly along the X, Y, or Z axis, respectively. If you use the RX, RY, or RZ key, the robot arm rotates on each axis of the tool coordinates.

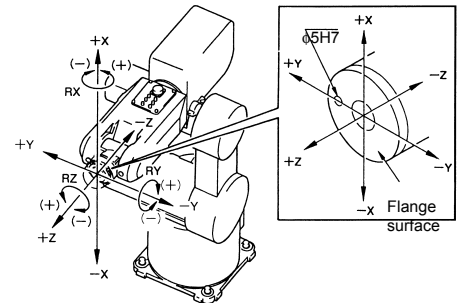

In this lesson, you will practice running the robot in X-Y mode.

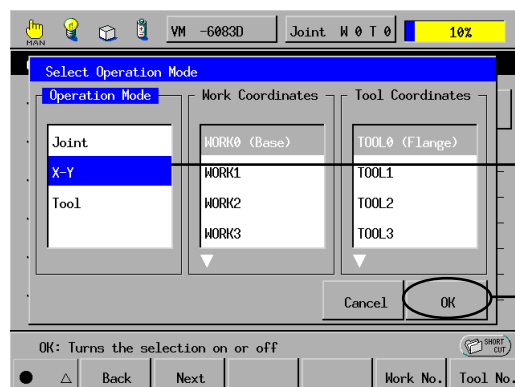

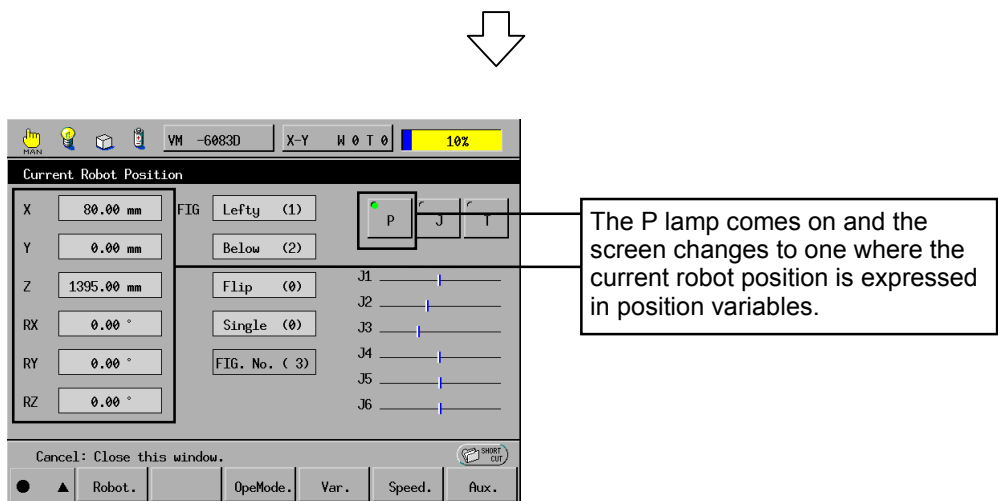
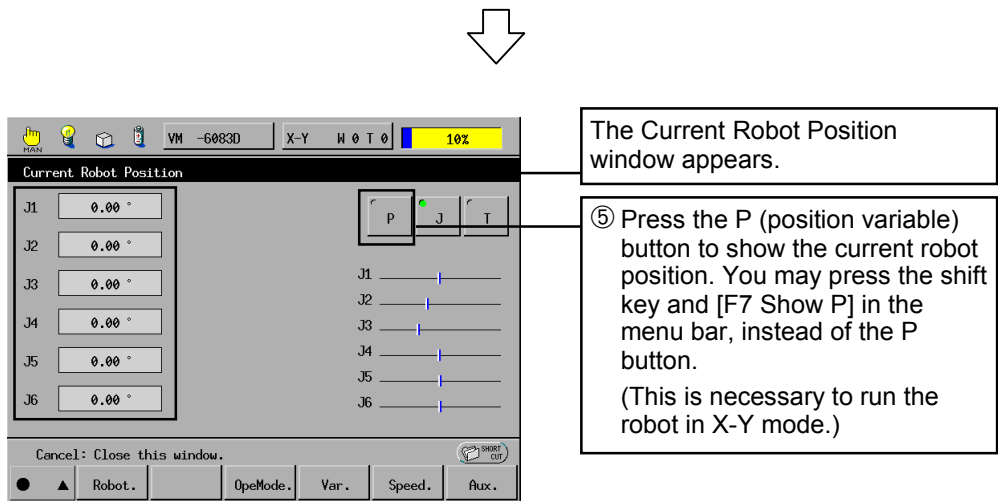
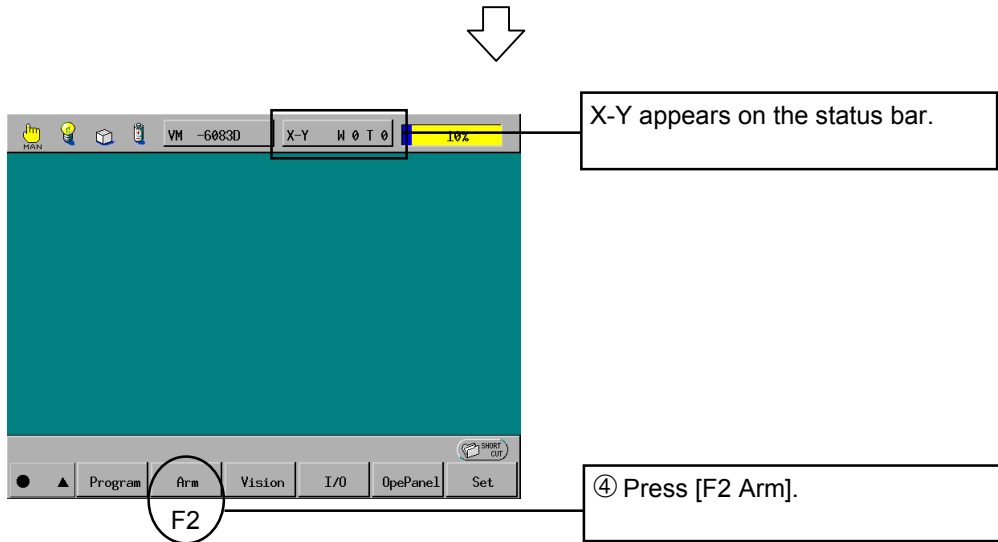

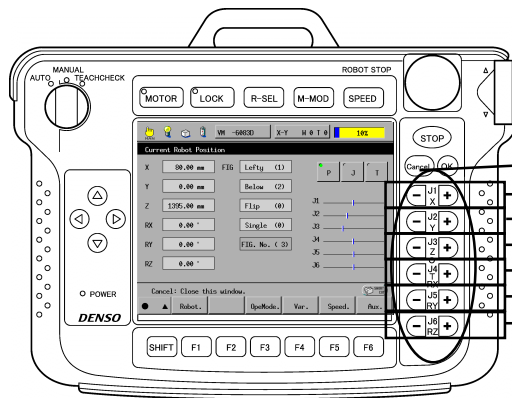

⑥ Run the robot by pressing the arm traverse keys with the deadman switch held down.

Arm traverse keys

- ① Motion in X direction
- ② Motion in Y direction
- ③ Motion in Z direction
- ④ Rotation around X axis
- ⑤ Rotation around Y axis
- ⑥ Rotation around Z axis

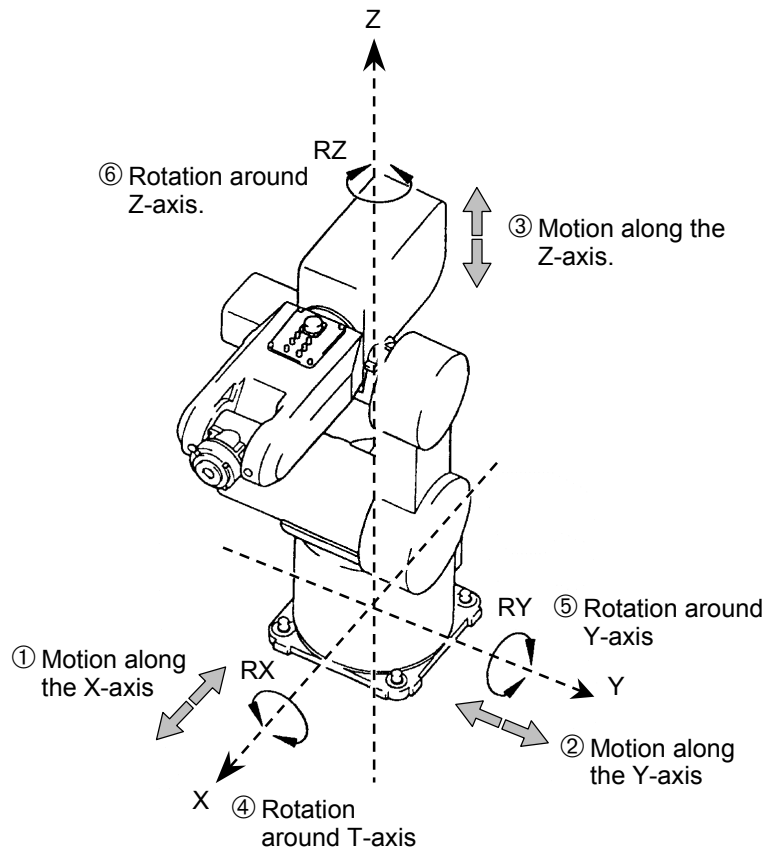
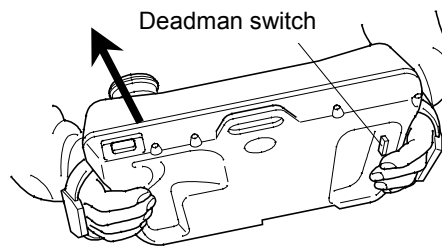

Lesson 2 Running the Robot Using a Simple Program

In order to run the robot in a designated way, it is necessary to create a program and teach the positions you want the robot arm to move to.

In this lesson, you will practice moving the robot arm from P1 to P2 as shown below. This will be described in the following order.

- 2.1 Creating a simple program from the teach pendant
- 2.2 Teaching (teaching of P1 and P2)
- 2.3 Teach check
- 2.4 Running the robot with automatic operation

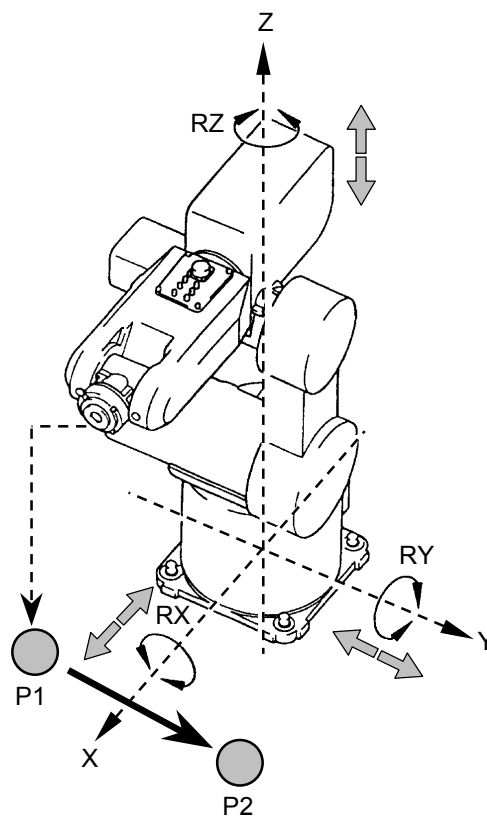

2.1 Creating a simple program from the teach pendant

First, you will enter codes of a simple program using the teach pendant.

Creating and editing of programs should be done in the Manual mode. If you take the following procedure immediately after performing the previous lesson, the robot is now in the Manual mode, so proceed as is. If not, you need to place the robot in Manual mode before proceeding.

Refer to the PROGRAMMER'S MANUAL for a detailed description on writing programs.

Step 1 Opening a program edit window

To create a new program, it is necessary to open the window for editing programs on the teach pendant screen.

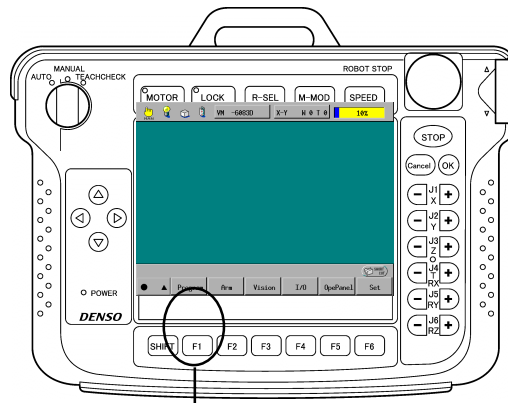

① Press [F1 Program] on the top screen.

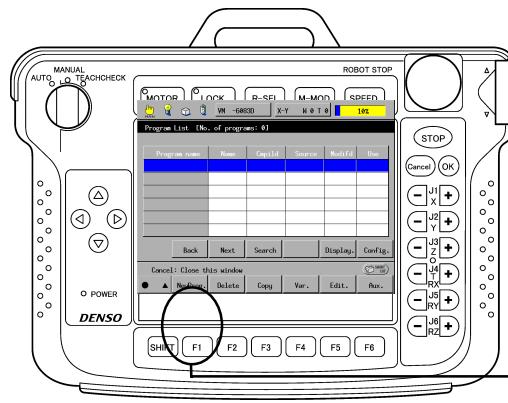

② Press [F1 NewProg.].

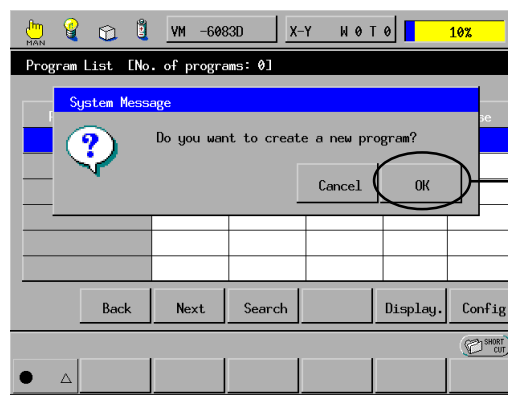

③ Press [OK].

Next, type the file name of the program (here we will use PRO1) to be created.

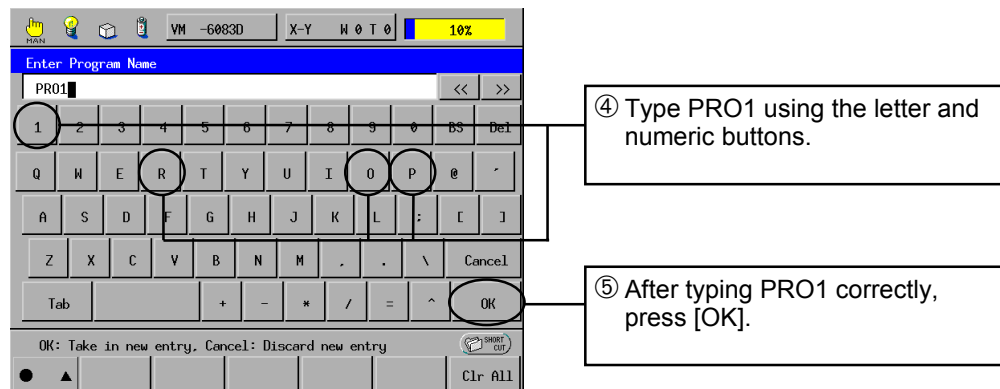

This ends the preparation for program editing.

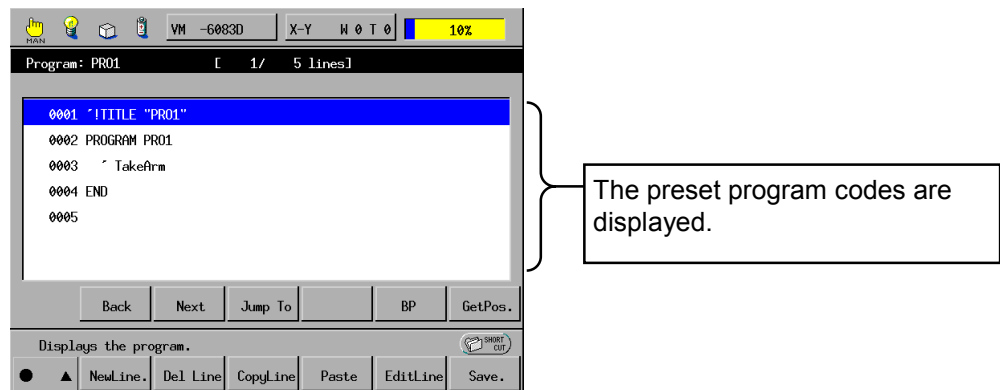

Step 2

Entering program codes

In this step, you will create a program to move from P1 to P2. Enter the program codes listed in the table below.

Coding List for "PRO1"

PROGRAM PRO1	
TAKEARM	'Acquires the arm semaphore
SPEED 100	'Specifies internal speed
MOVE L, P1	'Moves to specified coordinates for P1
MOVE L, P2	'Moves to specified coordinates for P2
GIVEARM	'Releases the arm semaphore
END	



① In the "Program: PRO1" window, move the cursor to the 3rd line using the cursor keys or jog dial.

② Press [F5 EditLine].

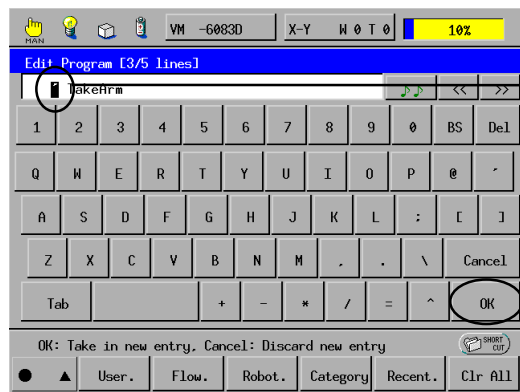

③ Delete the apostrophe (') from the head of the line using the cursor keys and [Del].

④ Press [OK].

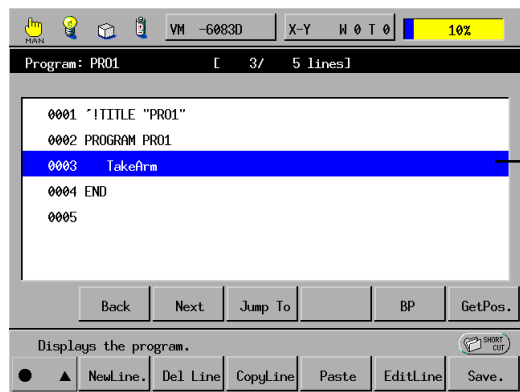

The screen shows the program edit window [Program: PRO1] again where the 3rd line has been modified.



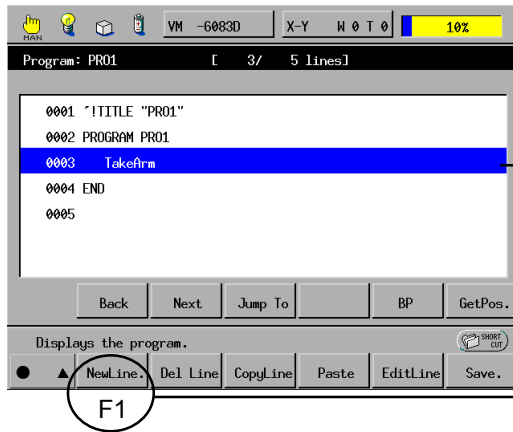

⑤ Move the cursor to the 3rd line and press [F1 NewLine.].

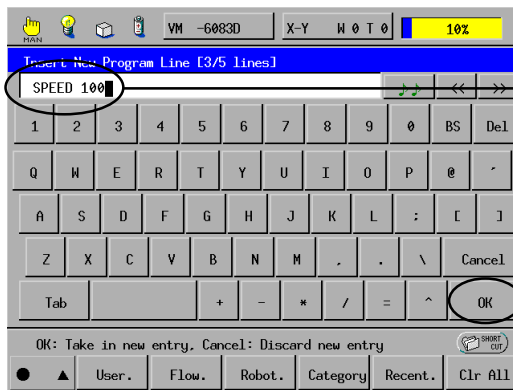

⑥ Enter "SPEED 100" from the keyboard. This is displayed in this window.

⑦ Press [OK].

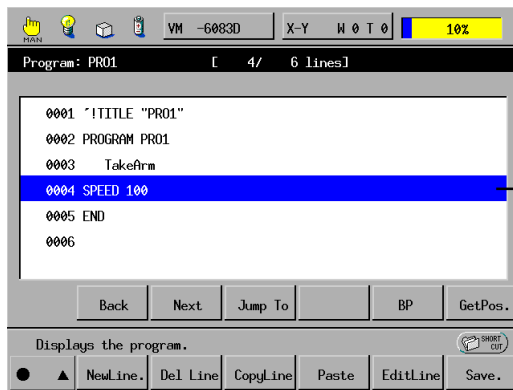

The program edit window "Program: PR01" appears where "SPEED 100" is displayed in the 4th line.



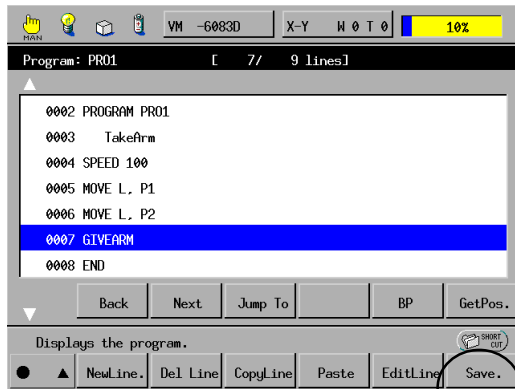

⑧ Enter all of the program codes given on p.16 in the same way used to enter "SPEED 100".

⑨ After completing entry of all codes, press [F6 Save.].



⑩ Press [OK] to save the newly entered program.

The display will return to the Program List window.

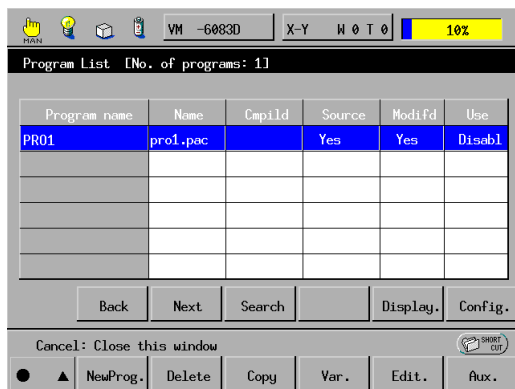

★Caution★

- ① If you do not want to save the changes made, press [Cancel] instead of [OK] and the display will return to the program edit screen without the changes being saved.
- ② To create a new program, go back to Step 1.

Step 3

Compiling the program into run-time format

After editing a program, you need to compile it; that is, transform the edited program into run-time format which is executable by the robot controller.

During compiling, syntax errors will be detected if contained in the edited program. You need to correct all syntax errors since programs containing them cannot be loaded or executed.

The image shows two screenshots of a robot controller interface. The top screenshot shows the 'Program List' window with a table containing one program, 'PR01'. A callout box points to the 'PR01' row. A second callout box points to the 'Config.' button in the bottom right corner of the window, which is circled and labeled 'F12'. A downward arrow points to the second screenshot. The second screenshot shows a 'System Message' dialog box overlaid on the program list. The dialog box asks 'Do you want to make compile flags active?' and has three radio button options: 'Make the specified program active.' (which is selected), 'All programs are active.', and 'All programs are inactive.'. A callout box points to the selected option. Another callout box points to the 'OK' button in the dialog box. A final downward arrow is at the bottom of the second screenshot.

Program name	Name	CompId	Source	ModId	Use
PR01	pr01.pac		Yes	Yes	Disabl

① Select "PRO1" in the Program List window.
(You may select it by using the cursor keys or jog dial, or by touching the screen directly.)

② Press [F12 Config.].

③ Select "Make the specified program active".

④ Press [OK].

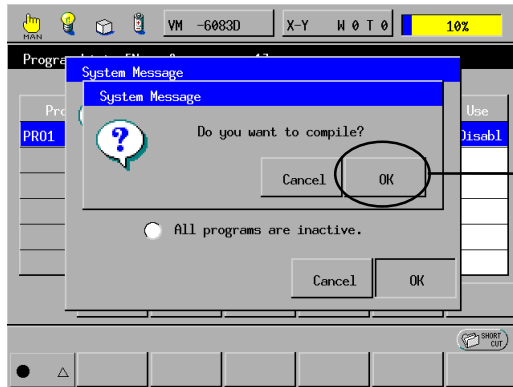

⑤ Press [OK].
Compiling will start.



When compiling is complete, the screen will return to the [Program List] window.

★Caution★

- ① If you press [Cancel] instead of [OK] at this point, the screen will return to the [Program List] window without performing the compiling operation.
- ② There is one other way with which you may compile programs into run-time format.
Press [F6 Aux.] in the [Program List] window to call up the [Auxiliary Functions (Programs)] window. In the window, press [F12 Compile]. With this method, you may continue on to load programs after compiling.

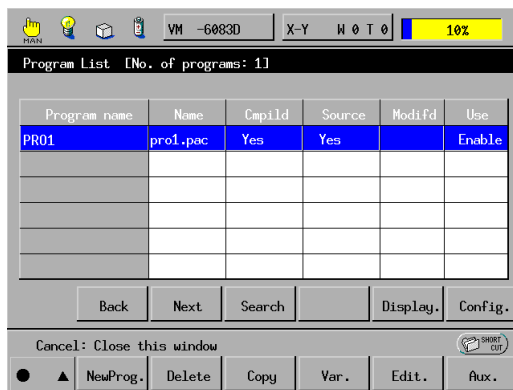

F6

Step 4

Loading the program

You need to load the compiled program so that the robot controller can execute it.

Even if compiled programs are transferred from the PC connected to the robot controller, they cannot execute. They need to be loaded to the memory area where the program can be executed.

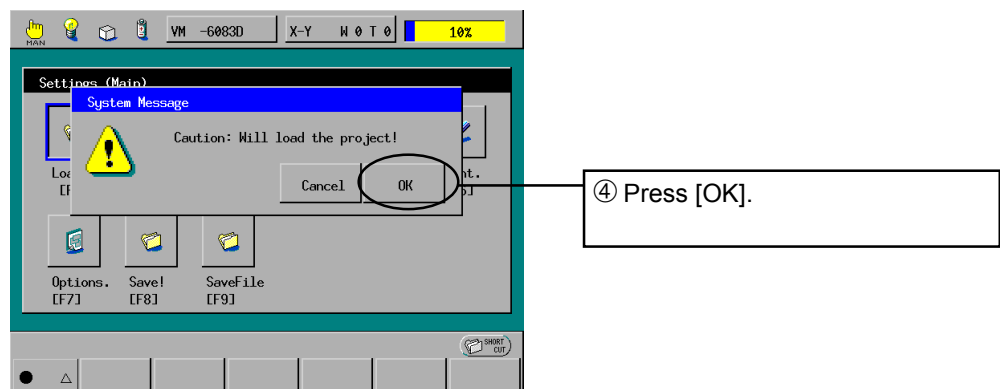
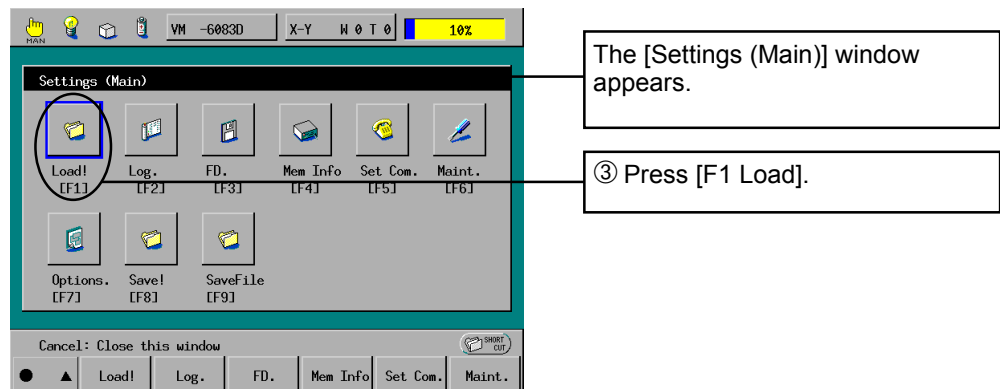
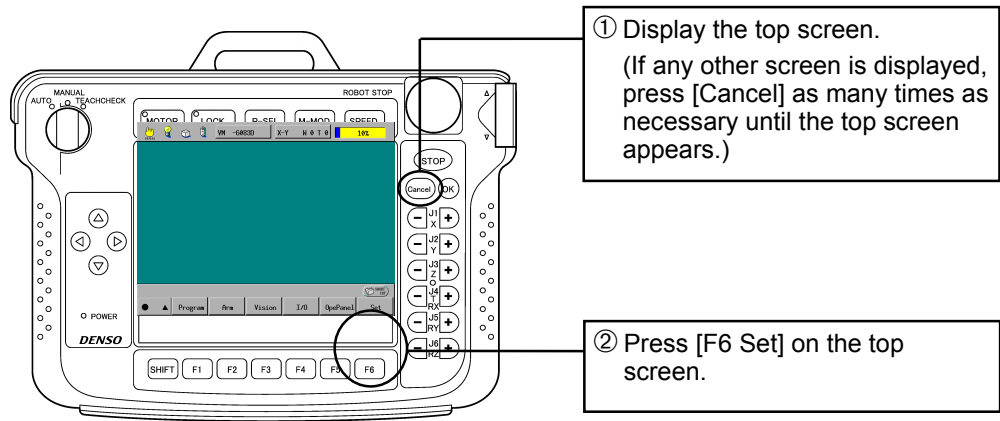

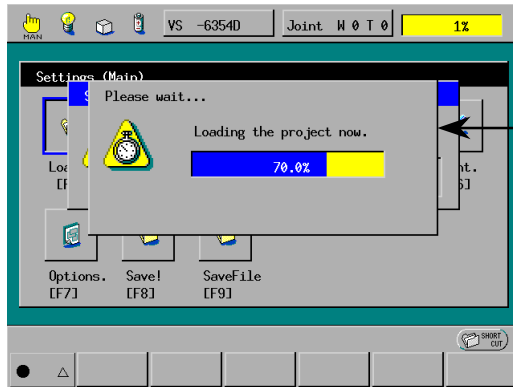

The message "Please wait... Loading the project now." is displayed.

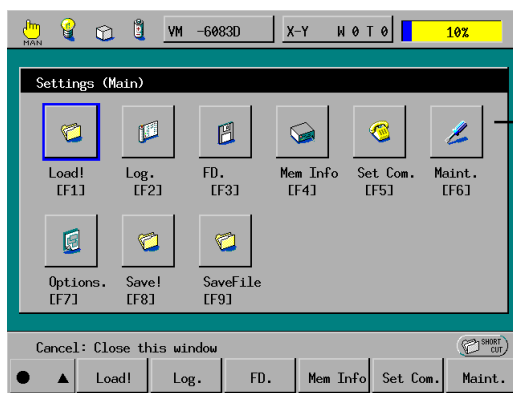

Upon completion of loading, the screen returns to the [Setting (Main)] window.

★Caution★

If you load a project using local variables different from those used in the previous project, the error message "Local variable initialized" appears. Press [OK] to continue.

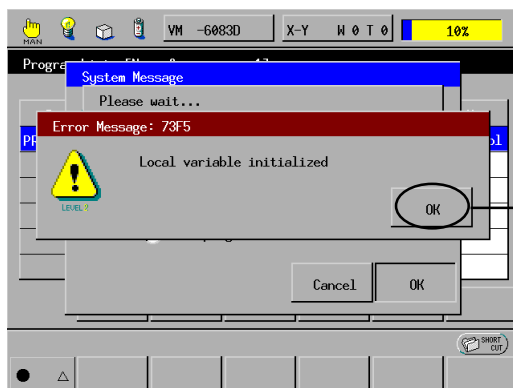

⑤ Press [OK].

Now, the program is ready to execute. Press [Cancel] to return to the top screen.

This completes the creation of the program to run the robot.

2.2 Teaching

Teaching refers to a method of programming in which you guide a robot through its motions using the teach pendant. In teaching, the robot is taught its motion.

In programming, you may specify positions as constants. However, in order to make the robot accurately learn the relative positional relationship between itself and objective point, you need to move the robot actually on site. Consequently, you write positions as variables in programming and assign actual values to those variables by on-site teaching.

The program created in Lesson 2.1 contains two position variables P1 and P2. This section gives you how to teach the robot values for P1 and P2.

Step 1

Teaching the robot position P1

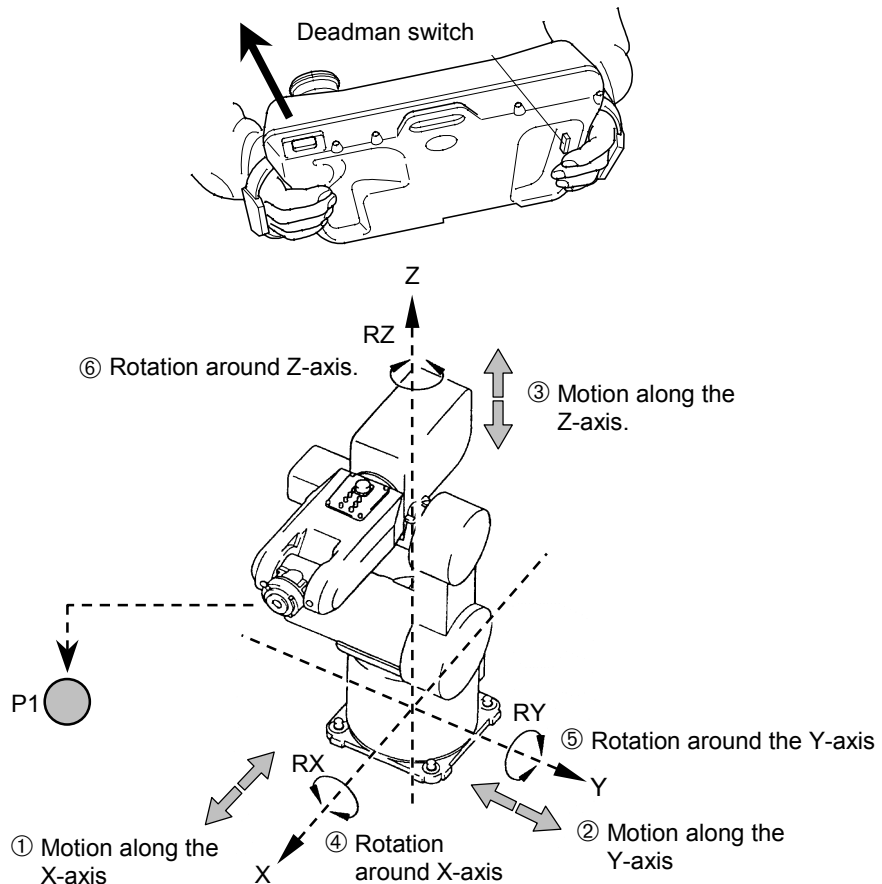
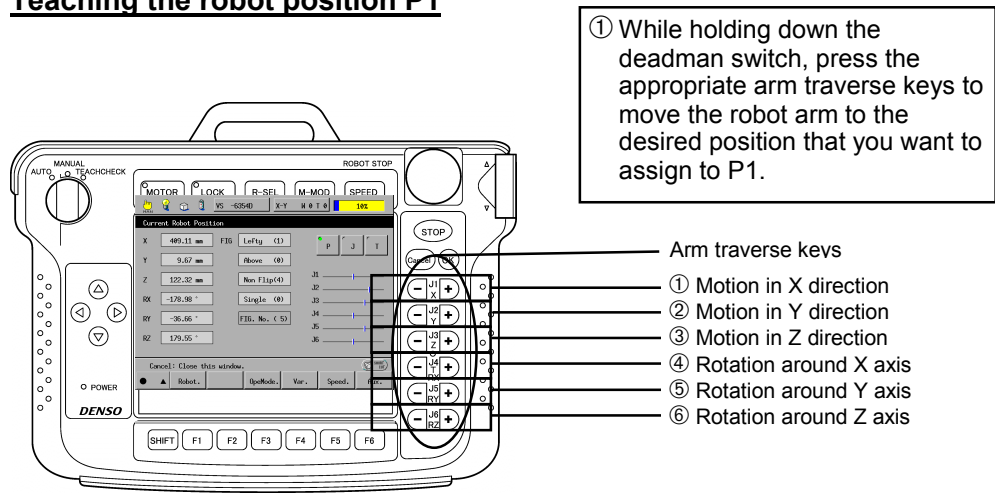

Step 2

Assigning the taught value to [Variable P1]

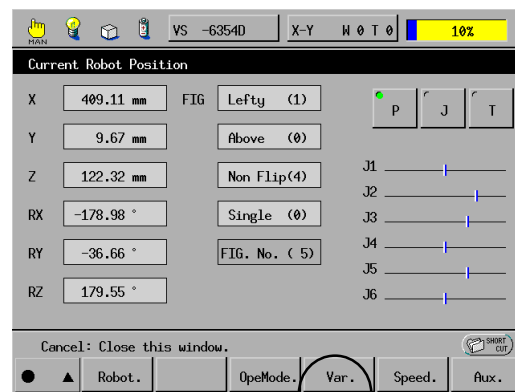

① Press [F4 Var.].

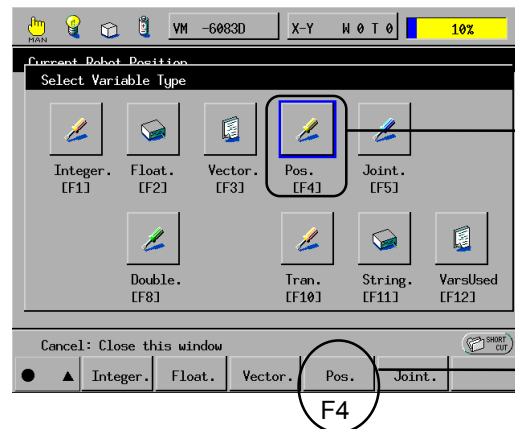

② Select the variable type in the [Select Variable Type] window. At this point, press [F4 Pos.] to assign a value to a position variable. (It is also possible to touch [Pos.] in the window.)

★Tip★

A variable refers to a program identifier for a storage location which can contain any number or characters and which may vary during the program. The following types of variables are supported:

- I. (Integer): Integer variable (range: -2147483648 to +2147483647)
- F. (Float): Floating-point variable (range: -3.402823E+38 to 3.402823E+38)
- D. (Double): Double-precision variable (range: -1.7976931348623157D+308 to 1.7976931348623157D+308)
- V. (Vector): Vector variable (X, Y, Z)
- P. (Pos): Position variable (X, Y, Z, RX, RY, RZ, FIG)
- J. (Joint): Joint variable (J1, J2, J3, J5, J6)
- T. (Trans): Homogeneous transform matrix variable (Px, Py, Pz, 0x, 0y, 0z, Ax, Ay, Az, FIG)
- S. (String): Character string variable (which can contain a character string of up to 247 characters)

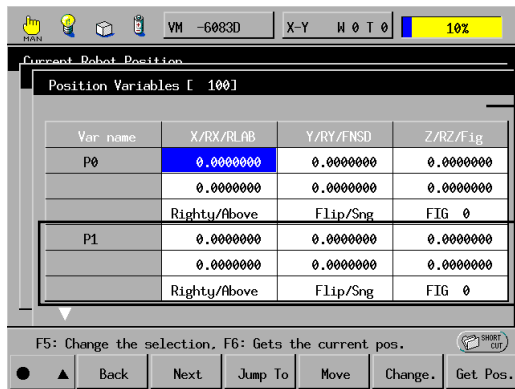

The [Position Variables] window appears.

③ Select the [P1] box using the cursor keys or jog dial.

The [Position Variables] window shows seven types of data for each variable name.

If you select and highlight any one of them, for example, any in the [Var name P1] box, then it means that the [Var name P1] is selected.

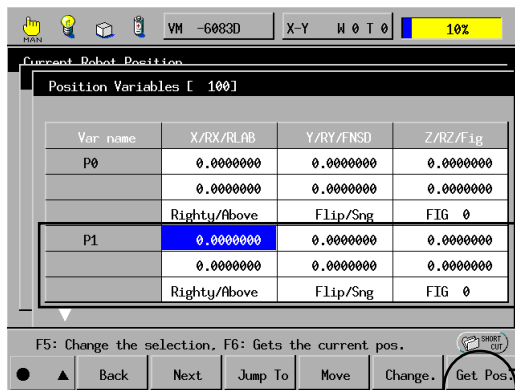

④ Check that the [Var name P1] is selected.

⑤ Press [F6 Get Pos.].

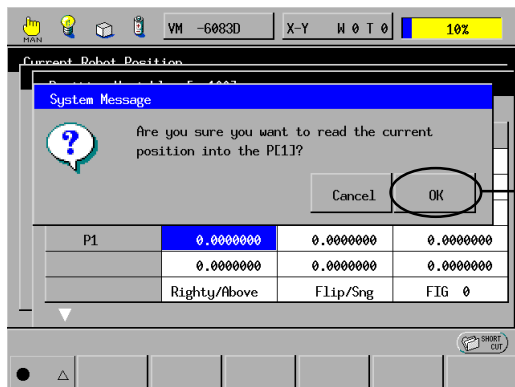

⑥ Check the system message and if all is correct, press [OK].



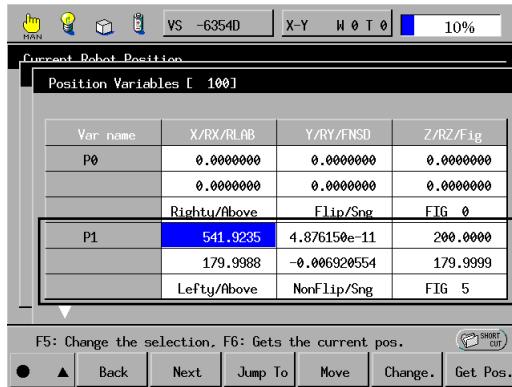

The current position will be read into variable P1.

Step 3

Teaching robot position P2 and assigning it to [Var name P2]

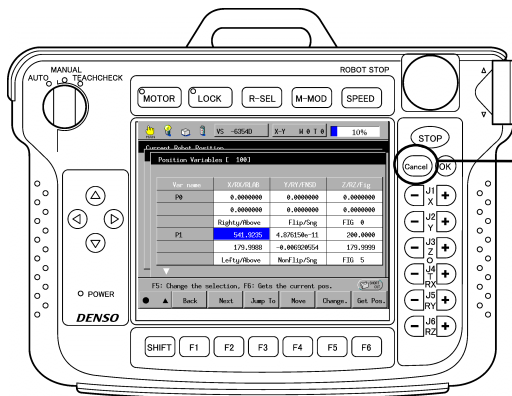

① Press [Cancel] twice to return to the [Current Robot Position] window.

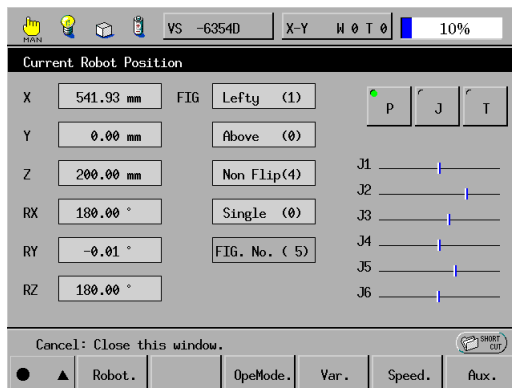

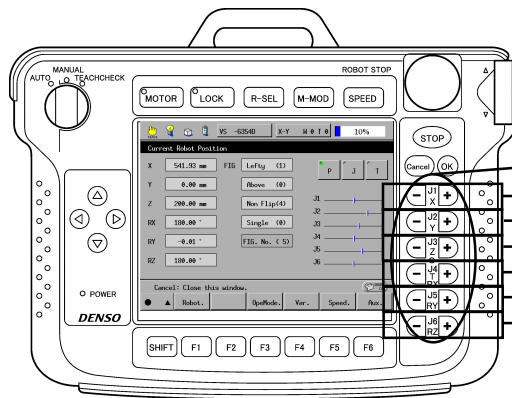

② While holding down the deadman switch, press the appropriate arm traverse keys to move the robot arm to the position to be assigned to P2.

Arm traverse keys

- ① Motion in X direction
- ② Motion in Y direction
- ③ Motion in Z direction
- ④ Rotation around X axis
- ⑤ Rotation around Y axis
- ⑥ Rotation around Z axis

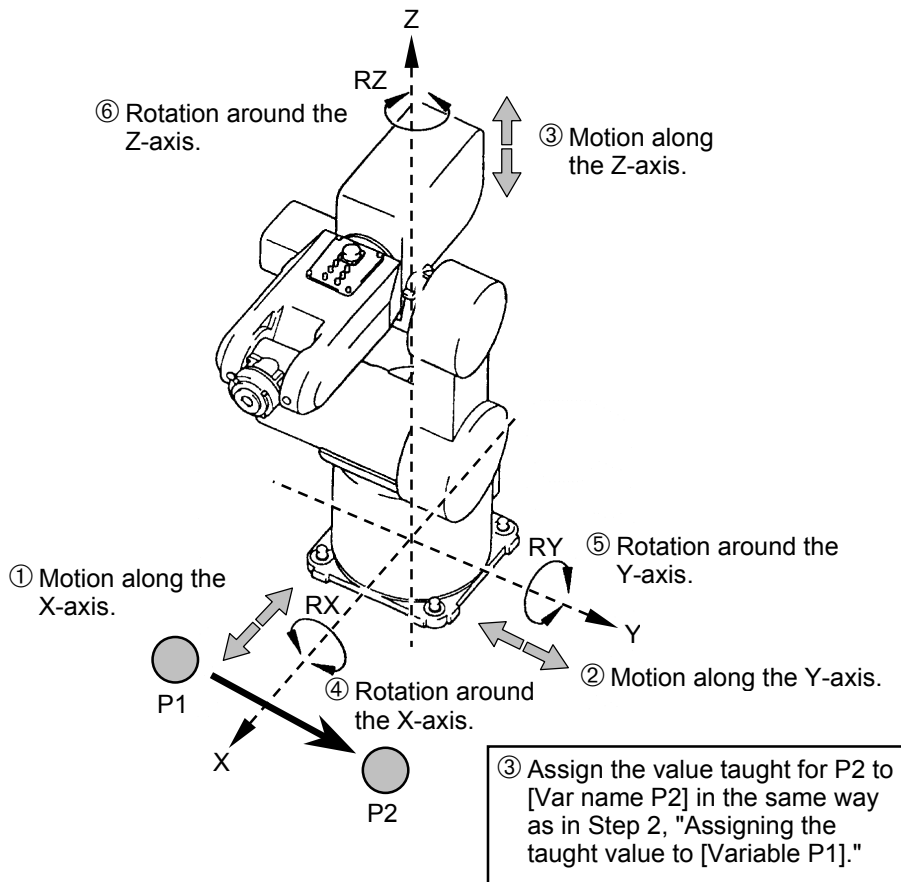
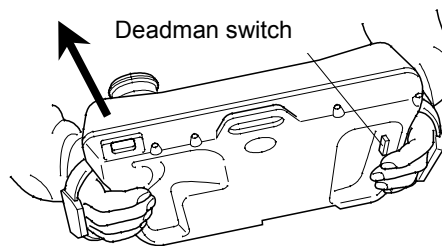

This completes the teaching of P1 and P2.

2.3 Teach check

"Teach check" refers to checking the teaching results by running the program manually. You may take the teach check procedure in Teach check mode.

Step 1 Placing the robot in Teach check mode

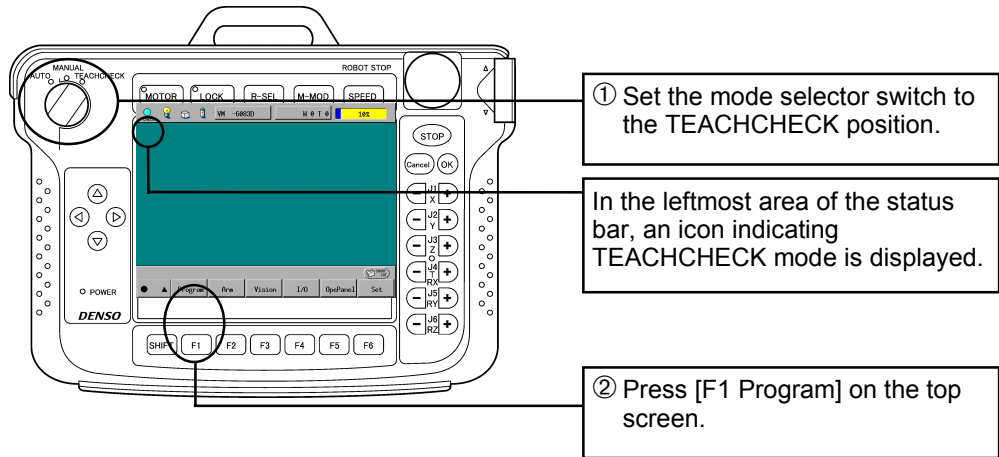

The Program List window appears.

Program name	Status	LineNo	RnTime	Priority	F/B
AUTOEXEC	On halt	4	0.00	128	∇ Fwd
PR07	On halt	3	0.00	128	∇ Fwd
PR042	On halt	3	0.00	128	∇ Fwd
PR085	On halt	2	0.00	128	∇ Fwd
PR01	On halt	3	0.00	128	∇ Fwd

Buttons: Back, Next, Search, Display, Config.

Cancel: Close this window

Buttons: Halt, StepStop, CycStart, StepBack, StpStart

Step 2

Step check

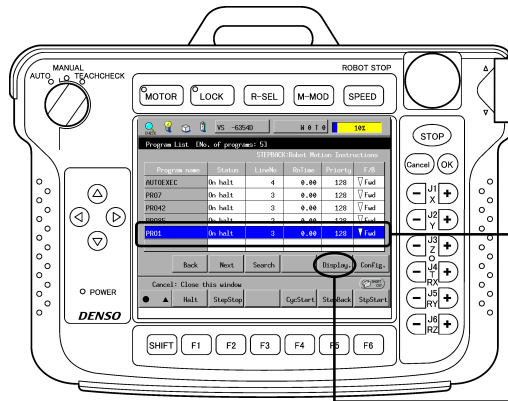

① Select "PRO1" in the Program List window.
(Selection can be made using the cursor keys or jog dial, or by touching the screen directly.)

② Press [Display.] to call up the PRO1 program codes.



The PRO1 coding list appears in the program edit window "Program: PRO1".

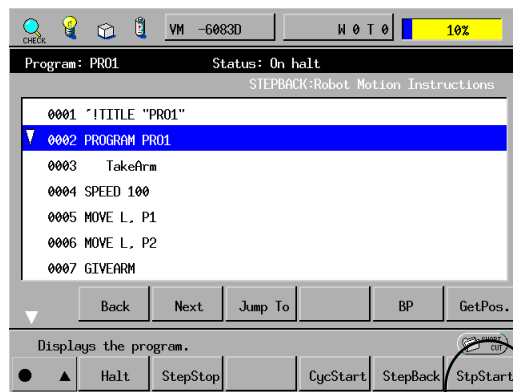

③ Press [F6 StpStart].
(This is also possible with the right cursor.)



This system message appears.

★Caution★

During teach check, always keep one hand free and ready to press the STOP key.



④ While holding down the deadman switch, press [OK].
(To cancel step operation, press [Cancel].)

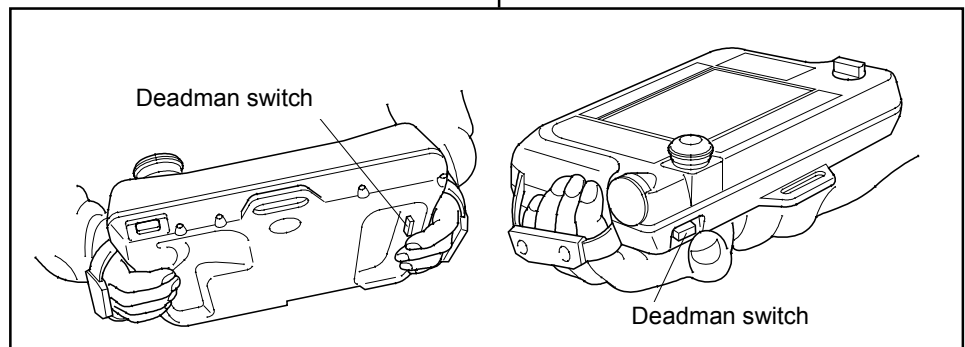

In Teach check mode, keep both the deadman switch and OK key depressed until the execution is completed. If either of them is released, the robot comes to a halt instantly.



Perform the procedure above repeatedly to execute all codes in PRO1, checking that each motion is safe.

Step 2

Cycle check

Next, check the program you have just checked with Step check, this time with Cycle check. The Cycle check executes the selected program from the current program line to the end as a single cycle.

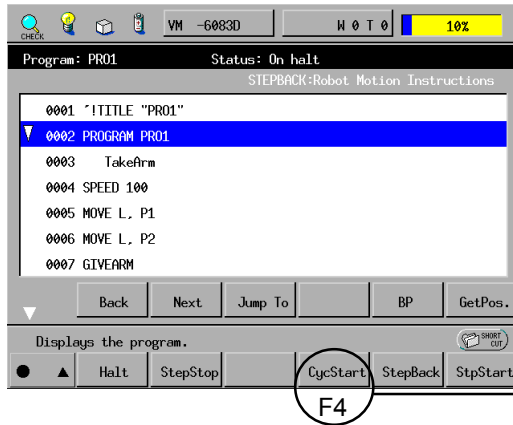

① Press [F4 CycStart].

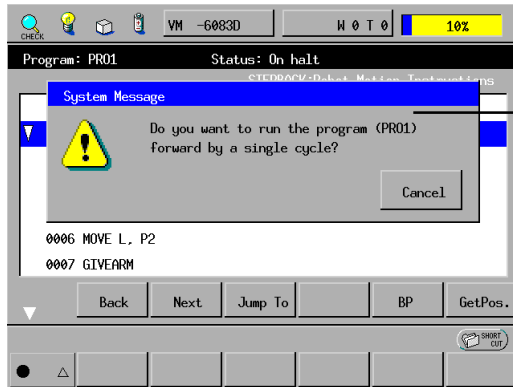

This system message appears.

★Caution★

During teach check, always keep one hand free and ready to press the STOP key.



② While holding down the deadman switch, press [OK]. (To cancel the cycle check, press [Cancel].)

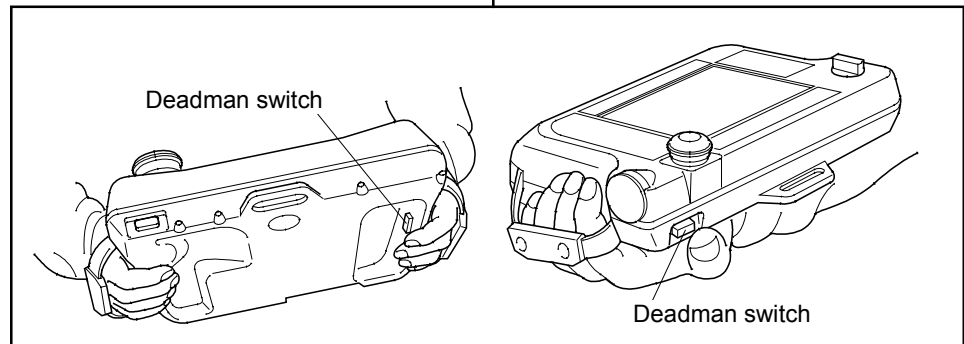

In Teach check mode, keep both the deadman switch and OK key depressed until the execution is completed. If either of them is released, the robot comes to a halt instantly.



As the program starts to execute cycle check so that the robot runs, the highlighted section on the coding list window will proceed in order.

When the program has been executed through to the end, it will stop.

2.4 Running the robot in Auto mode

After the teach check, now you will run the program in Auto mode according to the program PRO1 that you edited in the last section.

Caution: For programs that will be executed for the first time in Auto mode, set the reduced ratio of the programmed speed at 10% or less. In Auto mode, the robot may run at full speed, while in Manual mode or Teach check mode the robot speed is automatically reduced to 10% of the full speed.

Step 1 Placing the robot in Auto mode

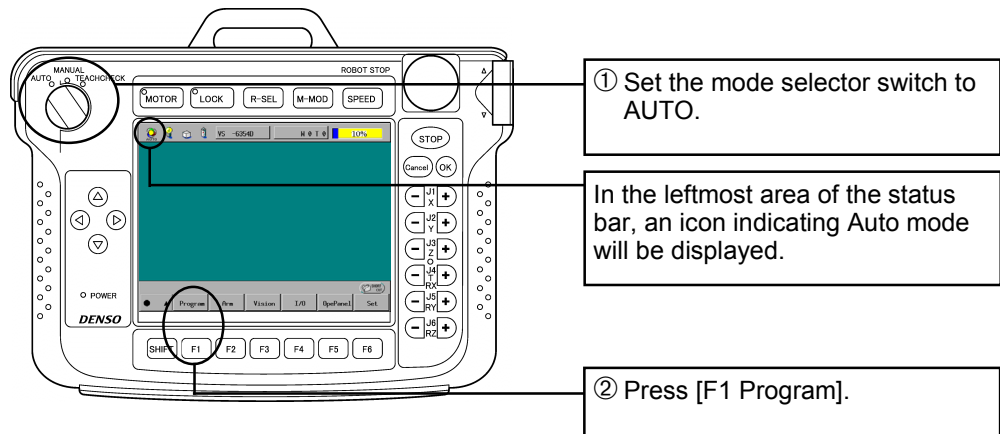

Step 2 Selecting the program to be executed

In the [Program List] window, select the program to be run in Auto mode.

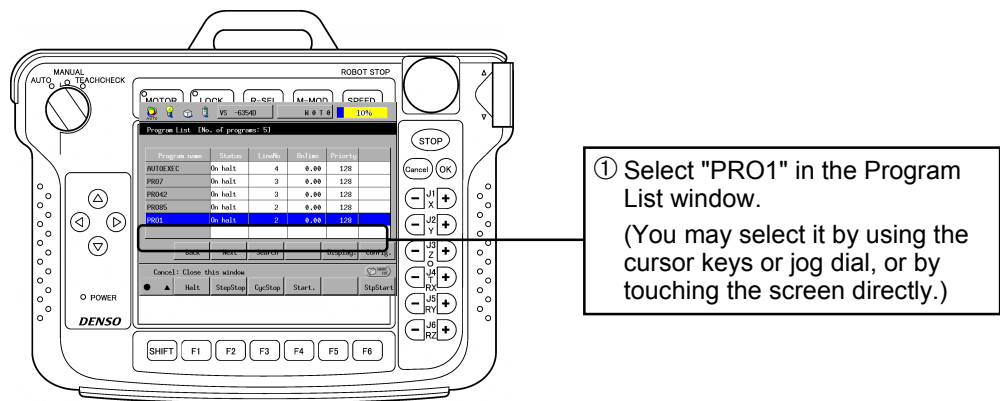

Step 3

Single-step run

★Note★

If you want to display the program during a single-step run, press [F11 Display] beforehand.

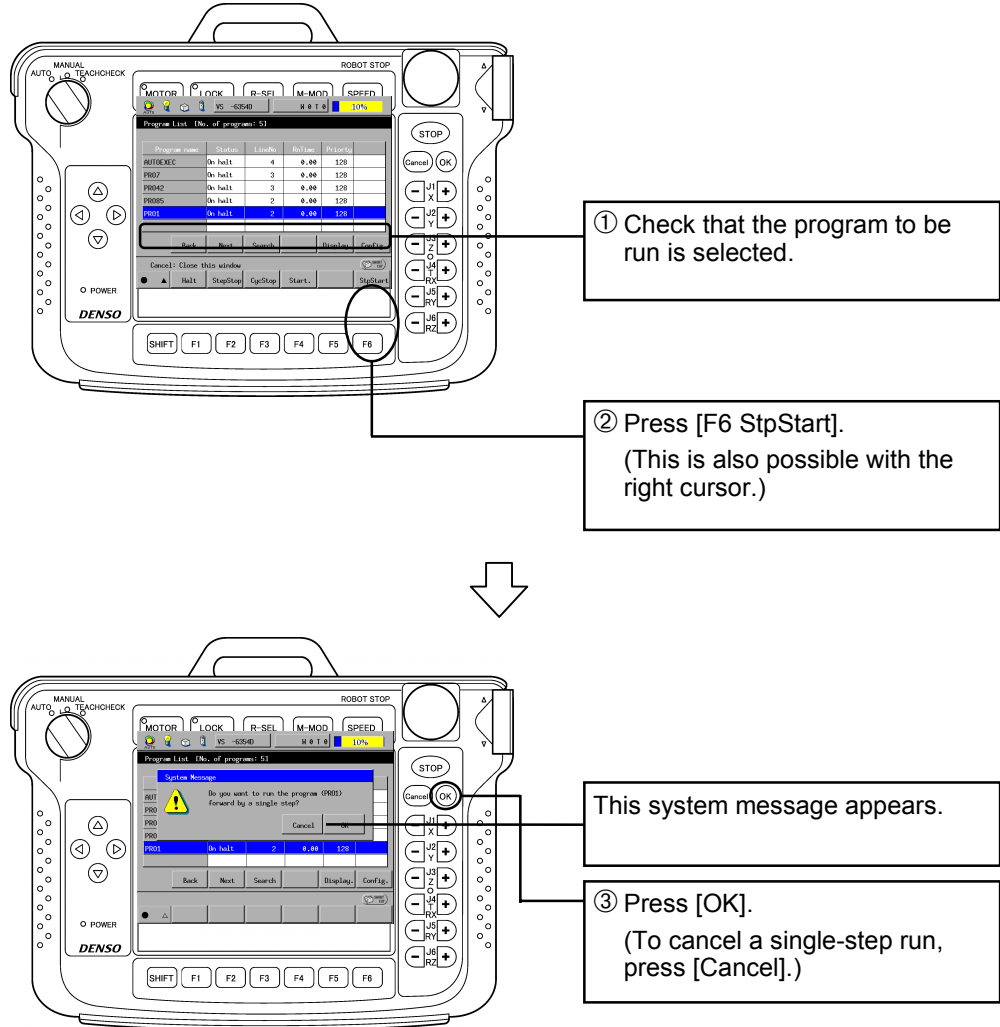

★Caution★

During program running, always keep one hand free and ready to press the STOP key.

The PRO1 program will start a single-step run in Auto mode.

Perform the procedure above repeatedly through to the end of the program, checking that each motion is safe.

Step 4

Single-cycle run

After running a single-step run, start a single-cycle run.

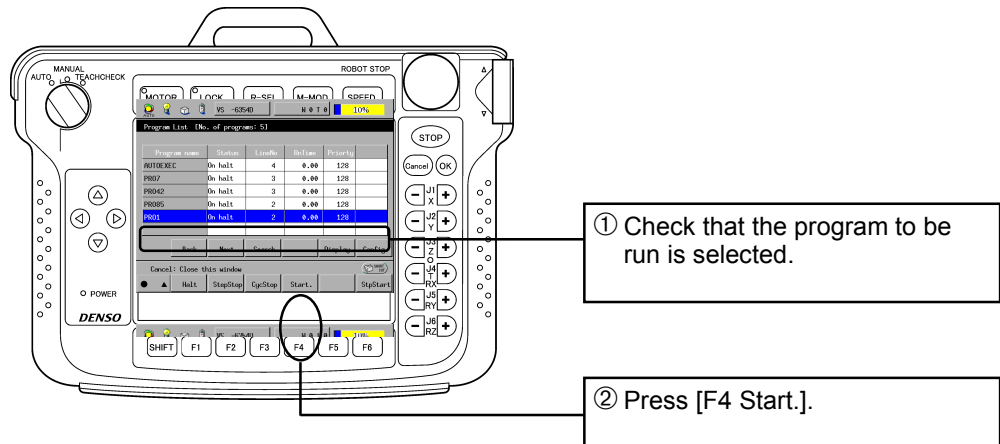

★Caution★

During program running, always keep one hand free and ready to press the STOP key.

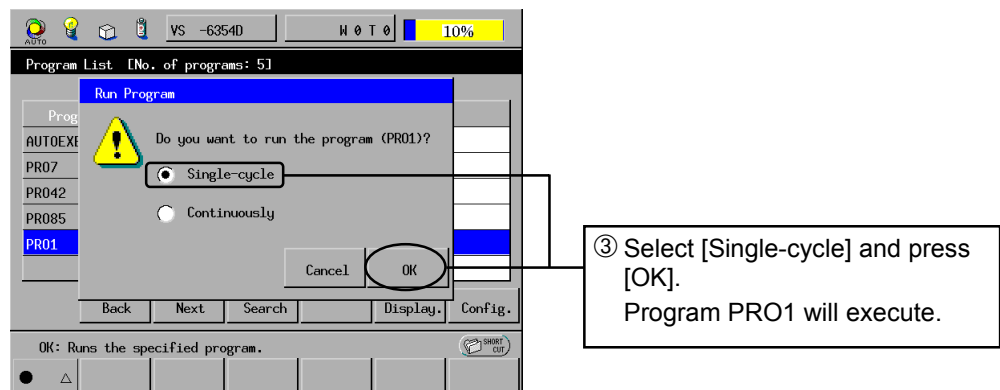

Once the program has been run to the end, it will stop.

★Caution★

The elapsed time on display refers to the length of time from the start to end of the program including temporary stop time caused by Step stop or Halt.

Step 5

Continuous run

Start a continuous run of the program.

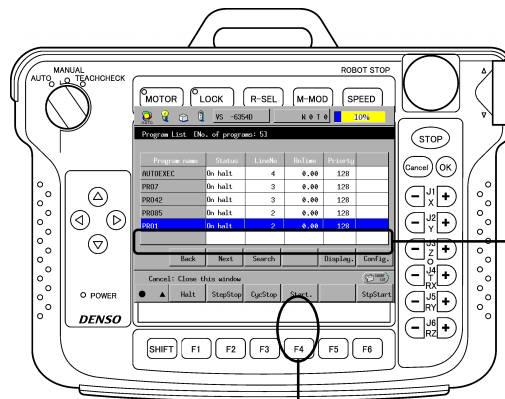

① Check that the program to be run is selected.

② Press [F4 Start.].

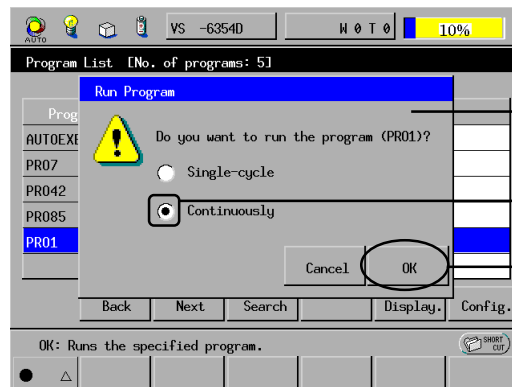

The selection screen for [Single-cycle] and [Continuously] is displayed.

③ Select [Continuously].

④ Press [OK].

Program PRO1 will execute continuously.
(You may stop continuous run by Halt (Stop) or Step stop.)

★Caution★

During program running, always keep one hand free and ready to press the STOP key.



This completes the procedures required to run the robot with the teach pendant.

Part 1 Practice Problems

Exercise: Create a program for moving a workpiece from point (A) to point (B), then perform an operation check.

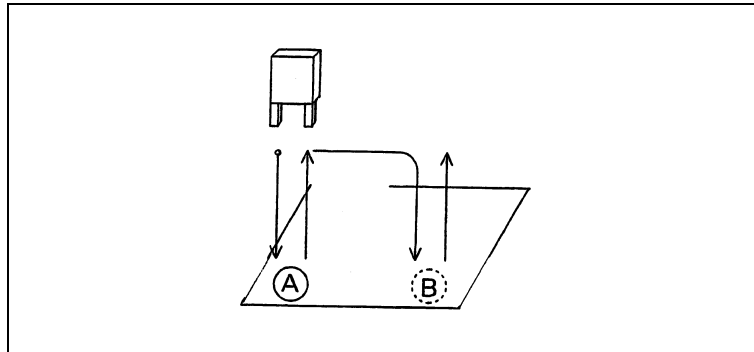

Assuming that:

- I/O assignment No. 64 (system output) ... Close hand
 No. 65 (system output) ... Open hand
- Speed ratio when collecting and putting a workpiece: 30%
 Speed ratio for other motions: 80%
- Each of the approach and depart distances: 50mm
- Interpolation control: PTP

Answer:

```
0001  '!TITLE "P&P"
0002  PROGRAM PRO10
0003      TAKEARM
0004      APPROACH P , P5 , 50 , S=80
0005      MOVE P , P5 , S=30
0006      DELAY 500
0007      RESET IO[65]
0008      SET IO[64]
0009      DEPART P , 50 , S=80
0010      APPROACH P , P6 , 50 , S=80
0011      MOVE P , P6 , S=30
0012      DELAY 500
0013      RESET IO[64]
0014      SET IO[65]
0015      DEPART P , 50 , S=80
0016      GIVEARM
0017  END
```

Part 2

Creating a Program on a PC in WINCAPSII

In Part 2, you will:

Start up the PC teaching system WINCAPSII on a personal computer and actually create and compile a program. You will then upload the compiled program to the robot controller.

Further, in Part 2, you will also place the robot controller in machine lock. This is in preparation for Part 3 where you will simulate the programmed robot motion on the PC screen without actually running the robot.

▶ Lesson 3	Setting Up the Robot Controller with the Teach Pendant	40
3.1	Performing calibration (CAL)	40
3.2	Placing the robot controller in machine lock	43
3.3	Setting the communications port of the robot controller	44
▶ Lesson 4	Starting Up WINCAPSII and Creating a System Project	48
4.1	Starting the System Manager	48
4.2	Registering a new system project	50
4.3	Setting the communications port of the PC	51
▶ Lesson 5	Defining Macros	53
▶ Lesson 6	Inputting and Editing Programs	55
6.1	Sample program	55
6.2	Opening the program edit window	56
6.3	Inputting program codes	57
6.4	Using the command builder	58
6.5	Saving the program	60
▶ Lesson 7	Compiling the Program into Run-time Format	61
▶ Lesson 8	Uploading the Program (PC → Robot controller)	62

Lesson 3 Setting Up the Robot Controller with the Teach Pendant

3.1 Performing calibration (CAL)

Calibration (CAL), which actuates all robot axes, is necessary to confirm the current position of the robot.

Warning Performing CAL operation will move the robot arm. Before proceeding with the CAL procedure, make sure that all workers have left the robot's restricted space and that there are no obstacles within.

Step 1 Placing the robot in Manual mode

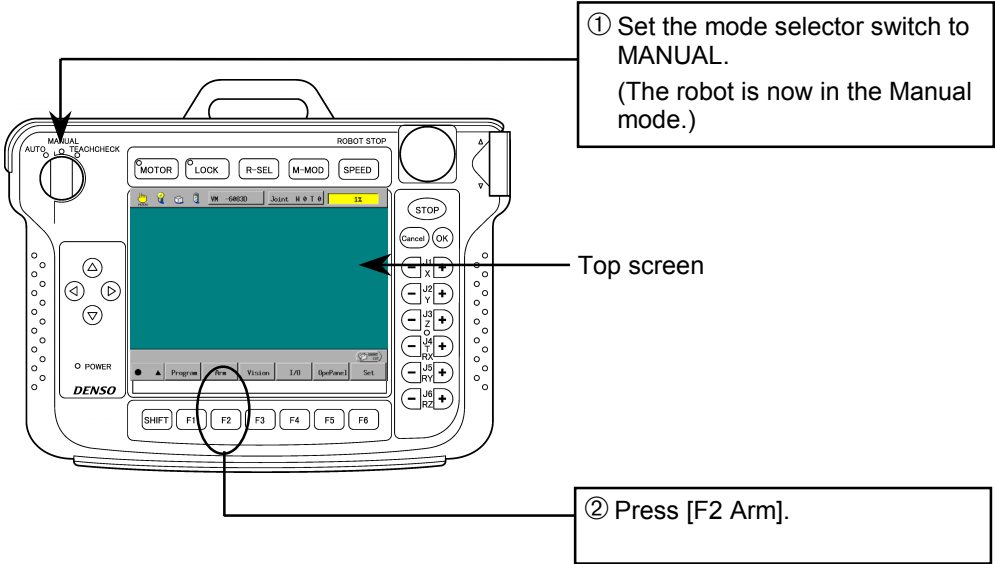

Step 2

Starting CAL operation

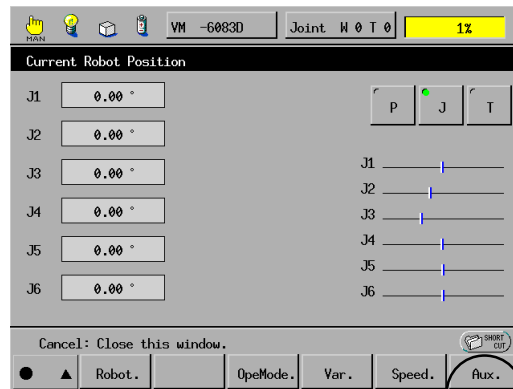

① Press [F6 Aux.].

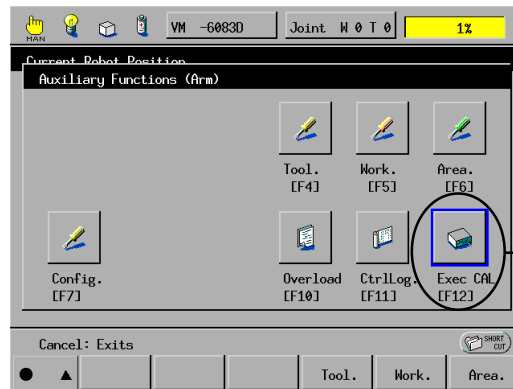

② Press [F12 Exec CAL].

Step 3

Turning the motor ON

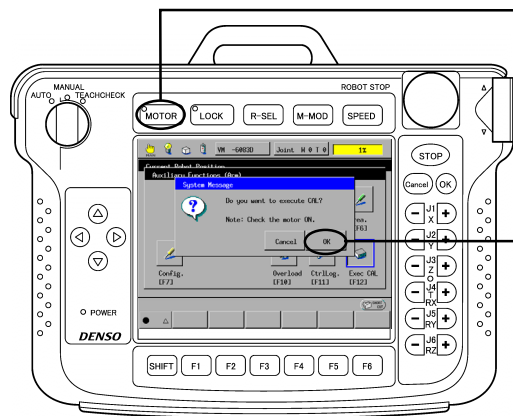

① Press [MOTOR].
The motor will be turned ON and the [MOTOR] lamp will light.

② Press [OK].

Step 4

Ending CAL operation

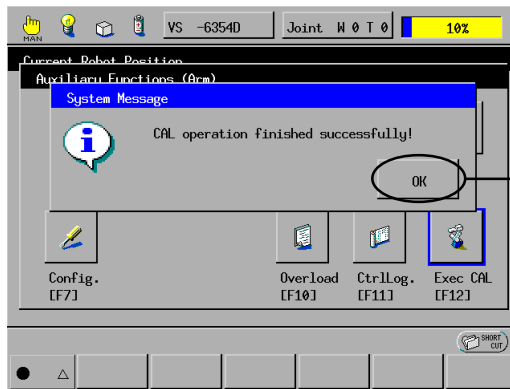

① Press [OK].

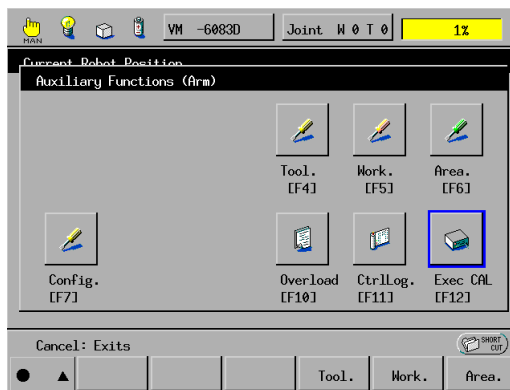

This completes CAL.

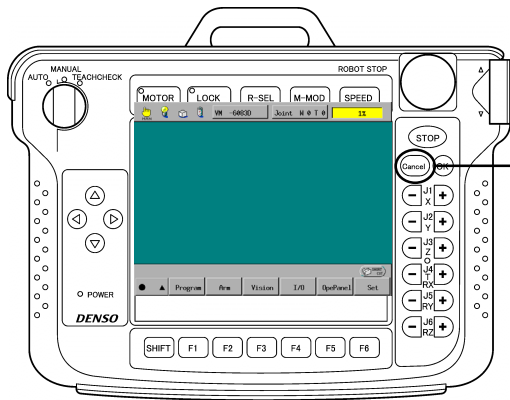

② Press [Cancel].
(The display returns to the [Robot Current Position] window.)

③ Press [Cancel].
The display returns to the top screen.)

3.2 Placing the robot controller in machine lock

You will now place the robot controller in machine lock. This enables you to simulate the programmed robot motion on the PC screen without actually running the robot in Part 3.

Step 1 **Turning the motor OFF**

Step 2 **Placing the robot in machine lock**

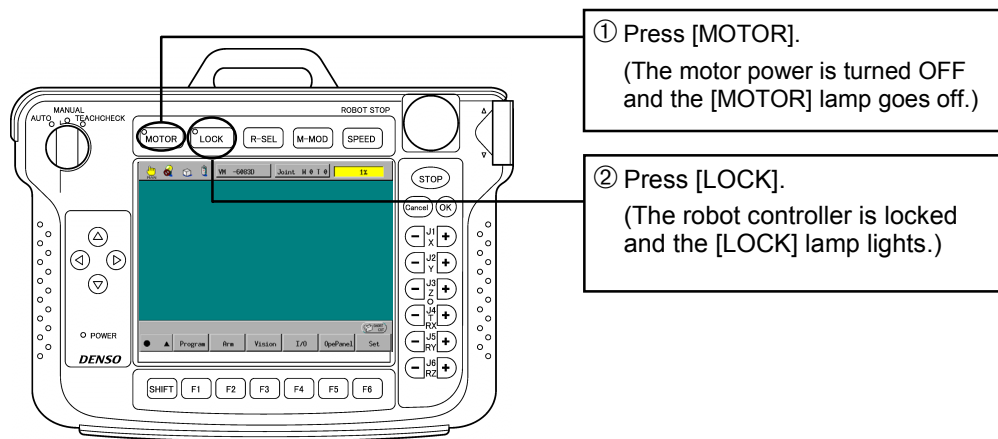

★Caution★ Before placing the robot controller in machine lock, ensure that the motor power is OFF; that is, check that the [MOTOR] lamp is off.

★Tip★ [Ver. 1.4 or later]

If the machine is locked, you may restrict I/O output. For details, refer to the SETTING-UP MANUAL, Section 5.5 "Displaying I/O Signals and Simulating Robot Motion."

The dummy input icon on the status bar changes according to the I/O output restriction condition.



: No I/O output restricted



: I/O output restricted

3.3 Setting the communications port of the robot controller

To enable the robot controller to communicate with the personal computer, you need to set up the communications port.

This subsection describes the most popular connection using the RS-232C.

Step 1

Setting the communication permission

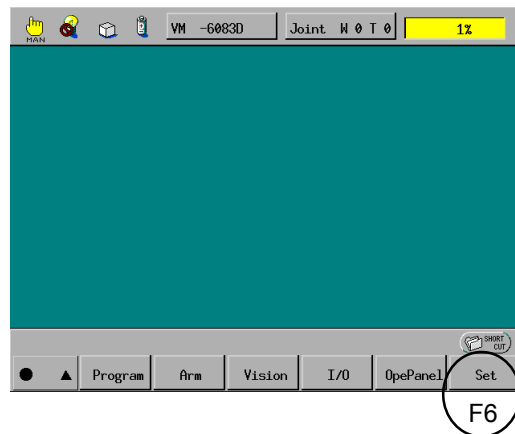

① Press [F6 Set].

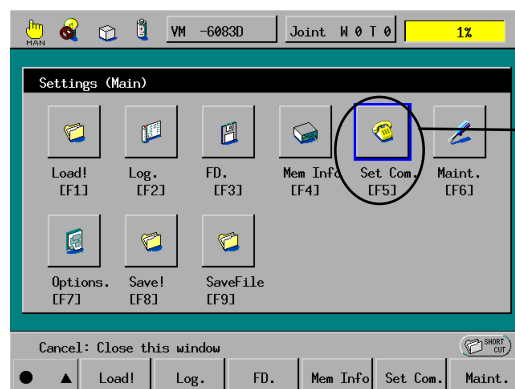

② Press [F5 Set Com.].

F5

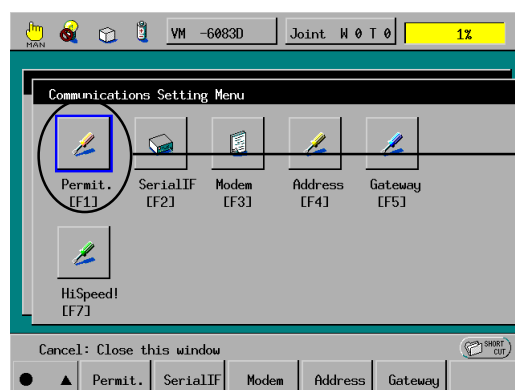

③ Press [F1 Permit.].

F1

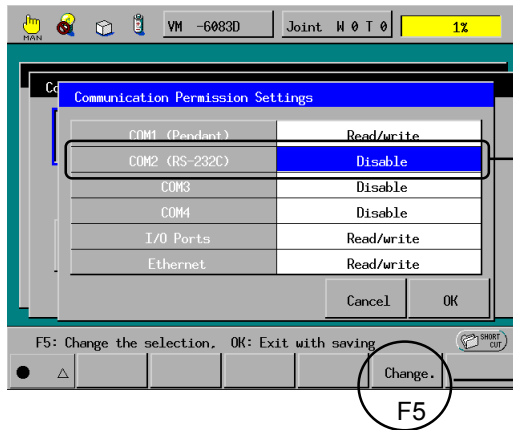

④ Select the [COM2 (RS232C)] row.

⑤ Press [F5 Change.].

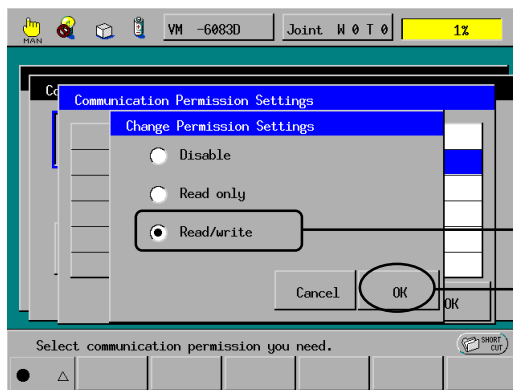

⑥ Select [Read/write].

⑦ Press [OK].

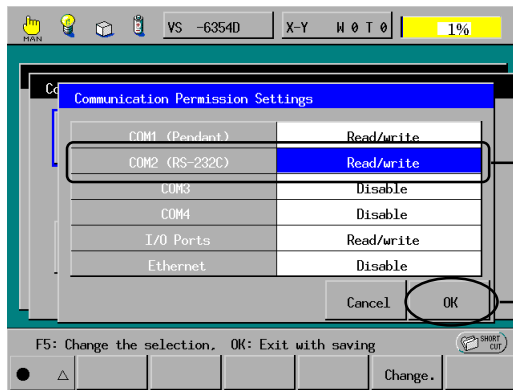

The [COM2 (RS232C)] column changes to [Read/write].

⑧ Press [OK].

Step 2

Setting the transmission rate

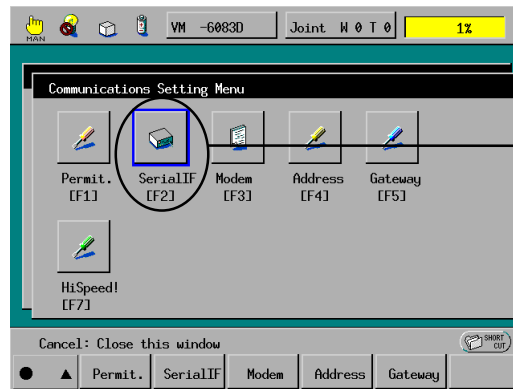

① Press [F2 Serial IF].

F2

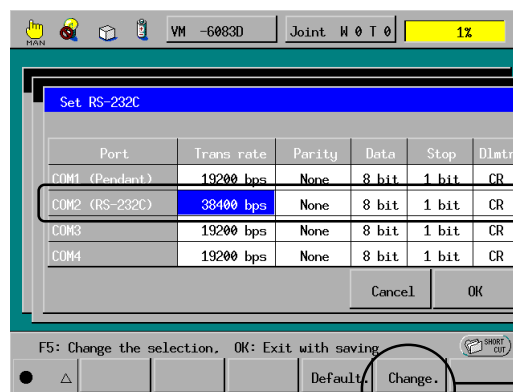

② Select the [COM2 (RS232C)] row.

③ Press [F5 Change.].

F5

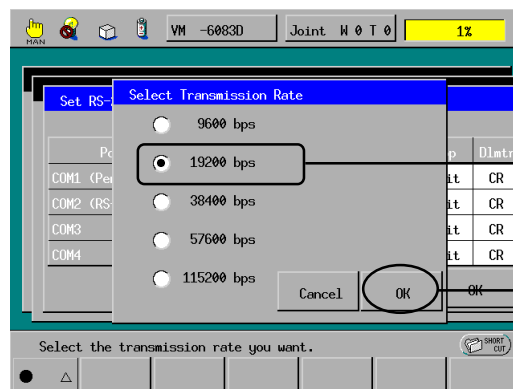

④ Select [19200 BPS].

⑤ Press [OK].

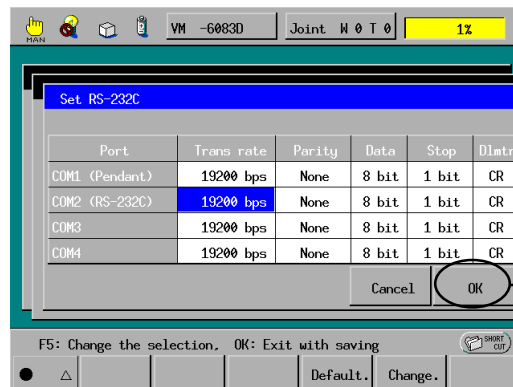

⑥ Press [OK].

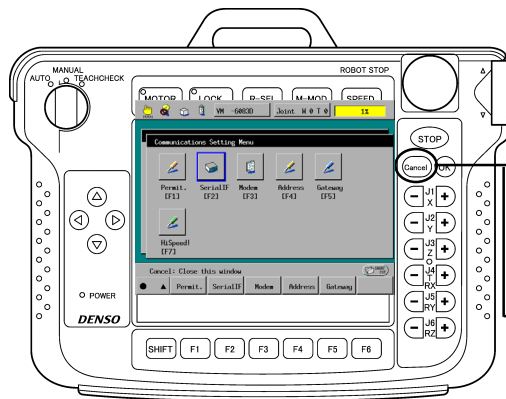

⑦ Press [Cancel].
 (The display returns to the [Communications Setting Menu].)

⑧ Press [Cancel].
 (The display returns to the top screen.)

Lesson 4 Starting up WINCAPSII and Creating a System Project

In this lesson, you will start up WINCAPSII with a PC and register a new system project. This is necessary in order to enter, edit and verify the program. You will also make settings for the communications port of the PC.

4.1 Starting the System Manager

WINCAPSII consists of the following functional modules:

- PAC Program Manager
- Variable Manager
- DIO Manager
- Arm Manager
- Vision Manager
- Log Manager
- Communications Setting Manager

System Manager enables overall control of these functional modules. All functions in WINCAPSII may be called up from the System Manager.

To use the PC teaching system, first start the System Manager as follows:

Step 1

Selecting System Manager

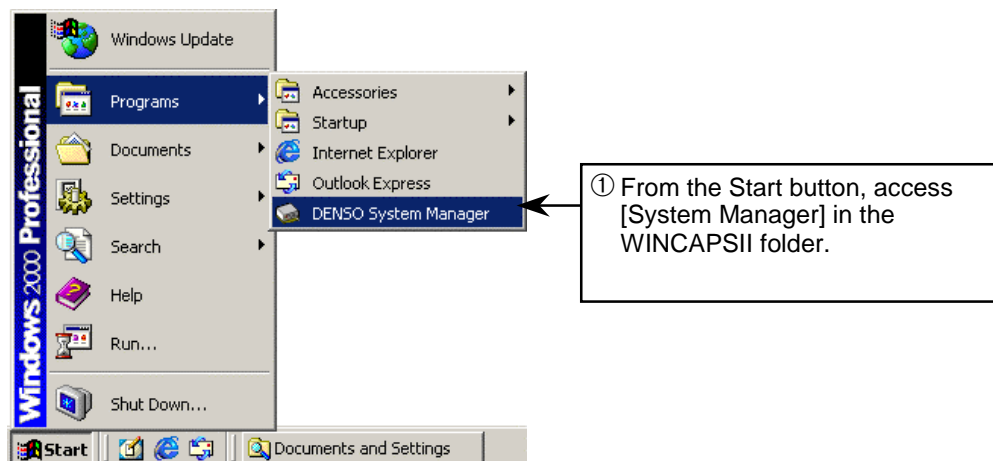

★Caution★

- When starting System Manager first time after installation, you need to specify the file name of the program bank. The "Create a New Program Bank" dialog may appear as necessary. Refer to the WINCAPSII GUIDE, Chapter 5, Subsection 5.6.2.3 "Updating the program bank."
- When starting the System Manager for the first time, the Create New Project dialogue box appears because no system project has been defined yet. In this case, you must first perform "4.2 Registering a new system project" before proceeding to Step 2.

Step 2

Selecting the user level

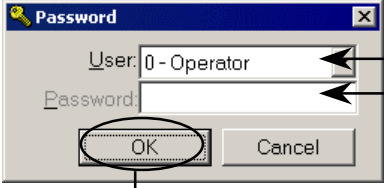

① Select the user level from the pop-up menu.

② Type the password if necessary.

③ Press [OK].

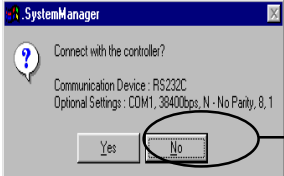

④ Click [No].

★Point★

Shown below are the startup buttons of the functional modules on the tool bar.



The System Manager is started and the [System Manager] window displayed. The buttons with icons are for starting each functional module.

System Manager

Variable Manager button

DIO Manager button

Arm Manager button

Vision Manager Button

Log Manager button

Communications Setting button

4.2 Registering a new system project

WINCAPSII controls more than one robot program in units of a project. To run a single robot, a set of combined programs will usually be used. Therefore, it is convenient to manage these programs as a set in one project.

For creating a robot program, first you should register a new project.

Caution: When starting the System Manager for the first time, the [Create New Project] dialog box will appear, so first carry out "New Project Registration" before proceeding to Step 2 of "4.1 Starting the system manager".

Step 1

Selecting "New Project" from [File] menu

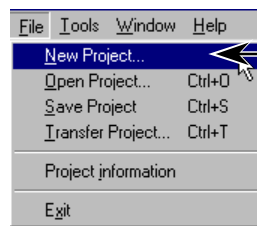

① Click here.

Step 2

Registering a new project

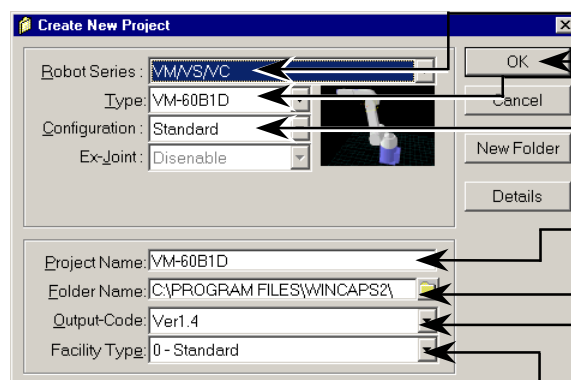

① Select VM/VS/VC

② Select VM-60B1D.

③ Select Standard.

④ Enter the desired project name.
(In this example, enter " VM-

⑤ Specify the folder name.

⑥ Specify the version number of the
execution program.

⑦ Select 0-Standard.

⑧ Click [OK].

4.3 Setting the communications port of the PC

Make the WINCAPSII communications settings the same as those of the robot controller.

Step 1

Calling up the [ROBOTalk Manager] dialog box



① Click on the [Communications Setting] button.

★Caution★

If you have not yet entered the password, the [Password] dialog box will appear. You need to select the user level and enter the password. (Refer to "4.1 Starting the system manager".)

Step 2

Setting the communication device and optional settings

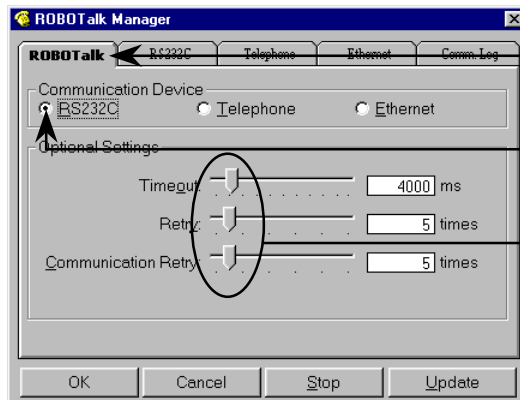

② Click the [ROBOTalk] tab.

③ Click here to select RS232C.

④ Make optional settings with these switches.
In this example, set the Timeout at 4000 msec, Retry at 5 times and Communication Retry at 5 times.

★Caution★

If timeout occurs during data transmission, adjust the timeout to a longer period.

Step 3

Setting the RS232C communications options

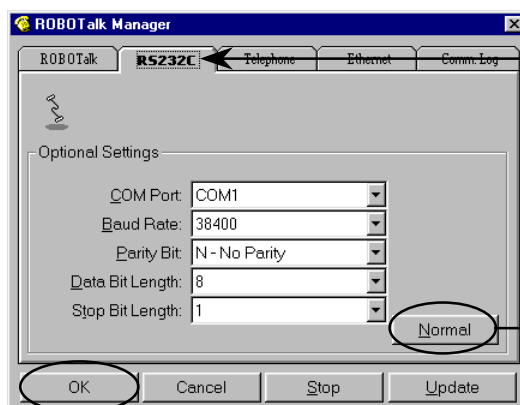

⑤ Click on the [RS232C] tab.

⑥ Click on [Normal].
The Optional Settings box changes to normal settings.

⑦ Click on [OK].
The settings become effective and the [ROBOTalk Manager] closes.

★Caution★ When making settings other than the normal settings, ensure the settings match the specifications of the robot controller or PC being used.

★Caution★ If [OK] is disabled, set the [Connect] button  for all managers to OFF. If any of the managers is connected, it will not be possible to change the communications settings.

Once performed, the WINCAPSII communications settings will remain effective until you change them again. You do not need to perform the settings each time you start WINCAPSII. Just click on [Yes] in response to the [Connect with the controller?] dialog message that appears when WINCAPSII is started up. If you click on [No], no automatic settings will be made.



Lesson 5 Defining Macros

In this lesson you will create macro definition files by defining names and applications of variables and I/Os.

Step 1

Creating a variable macro definition file



① Click on the Variable Manager button to start up the Variable Manager.

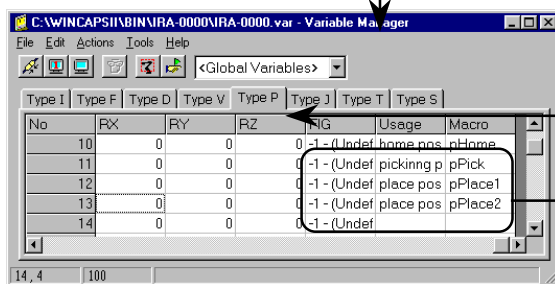

The [Variable Manager] window appears.

② Click on the [Type P] tab.

③ Double click on each box and enter the usage and macro names of the variables. In this example, enter position variables P10 to P13.

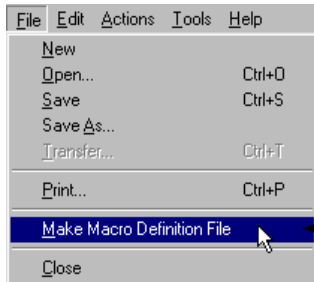

④ Click on [Make Macro Definition File].

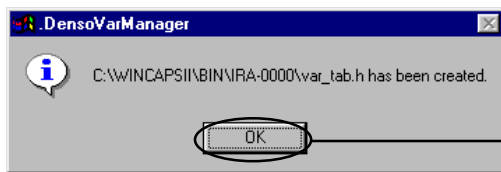

⑤ Press [OK]. The macro definition file is now created.

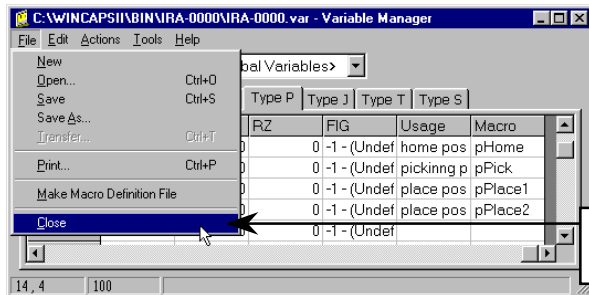

⑥ Click here to exit Variable Manager.

Step 2

Making an I/O macro definition file



① Click on the DIO Manager button to start up the DIO

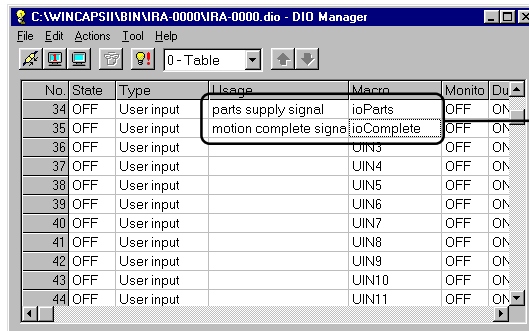

② Double click on each box and enter the usage and macro names of the I/Os.

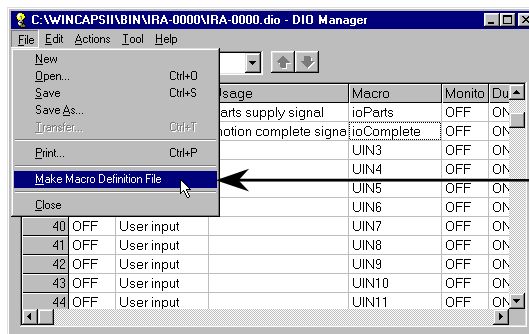

③ Click on [Make Macro Definition File].

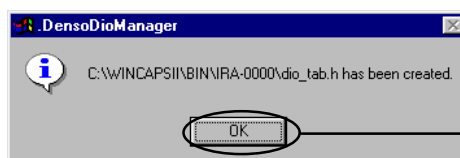

④ Press [OK].
The I/O macro definition file is now created.

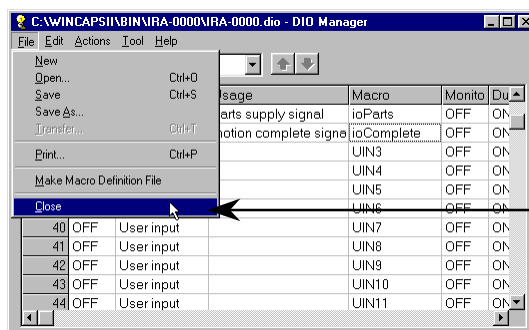

⑤ Click [Close] to exit DIO Manager.

Lesson 6 Inputting and Editing Programs

6.1 Sample program

Before starting the program input procedure, take a look over the coding list sample below.

Read through the process to get an understanding of the motion, while referring to the comments to the right.

Coding List "PRO1"

```
'!TITLE "Pick & Place"
#INCLUDE "dio_tab.h"           'Reads the DIO macro definition file.
#INCLUDE "var_tab.h"         'Reads the variable macro definition file.

PROGRAM pro1
    TAKEARM                   'Acquires arm semaphore.
    SET IO[ioComplate]
    MOVE P, P[pHome], S=50    'PTP control to home position at 50% internal speed
    SPEED 100                 'Changes to 100% speed.
    APPROACH P,P[pPick],200
    MOVE P,P[pPick]
    GOSUB *ChuckItem
    DEPART P,200
    APPROACH P,P[pPlace1],200
    MOVE P,P[pPlace1]
    GOSUB *UnchuckItem
    DEPART P,200
    SET IO[ioComplate]       'Issues a motion complete signal.
    GIVEARM                  'Releases arm semaphore.
    END

' ===== Parts chuck =====
*ChuckItem:
RESET IO[ioUnChuck]
SET IO[ioChuck]
RETURN

' ===== Parts chuck =====
*UnchuckItem:
RESET IO[ioChuck]
SET IO[ioUnChuck]
RETURN
```

6.2 Opening the program edit window

To input and edit task programs, use the Program Manager which is called up from the System Manager.

Step 1

Starting PAC Program Manager



① Click on the PAC Program Manager button to start the PAC Program Manager.

Step 2

Opening the program edit window

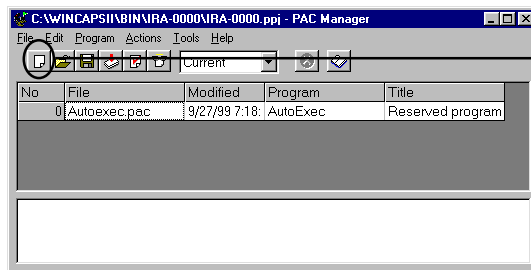

② Click on the [New Program] button.

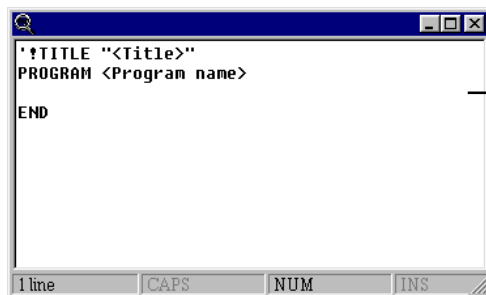

A new edit window appears.

6.3 Inputting program codes

Step 1 Typing the program title

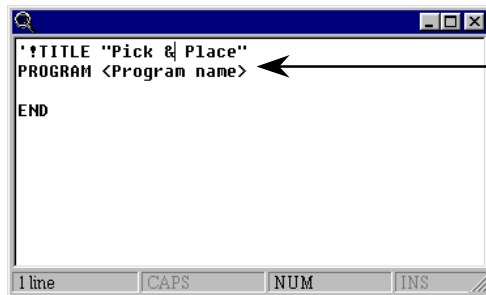

```
*!TITLE "Pick & Place"  
PROGRAM <Program name>  
  
END
```

① Type the program title. (In this example, type "Pick & Place".)

Step 2 Typing the program name

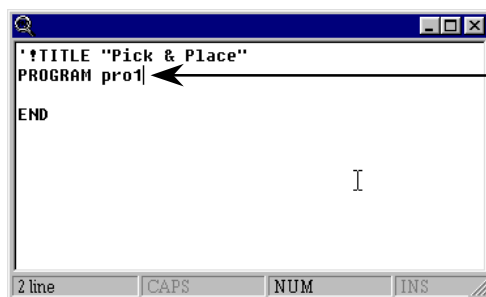

```
*!TITLE "Pick & Place"  
PROGRAM pro1  
  
END
```

② Type the program name. (In this example, type "pro1".)

Step 3 Inputting the program codes

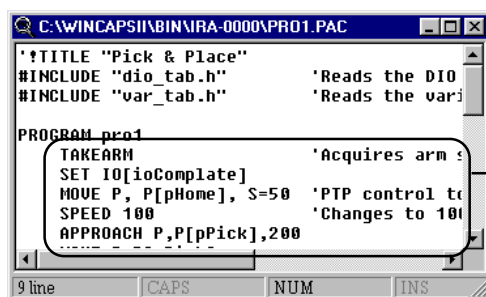

```
*!TITLE "Pick & Place"  
#INCLUDE "dio_tab.h" 'Reads the DIO  
#INCLUDE "var_tab.h" 'Reads the vari  
  
PROGRAM pro1  
TAKEARM 'Acquires arm  
SET IO[ioComplate]  
MOVE P, P[pHome], S=50 'PTP control to  
SPEED 100 'Changes to 100  
APPROACH P,P[pPick],200
```

③ Input the "Pick & Place" program codes.

6.4 Using the command builder

You may input program codes to the program edit window by using the keyboard, just as with a word processor. However, the Program Manager is provided with the command builder function, allowing you to enter commands with ease. This section describes how to enter commands using the command builder.

Step 1

Selecting the command builder

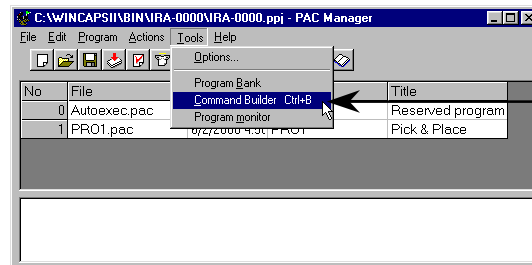

① Select [Command Builder] from the [Tools] menu.

Step 2

Using the command builder

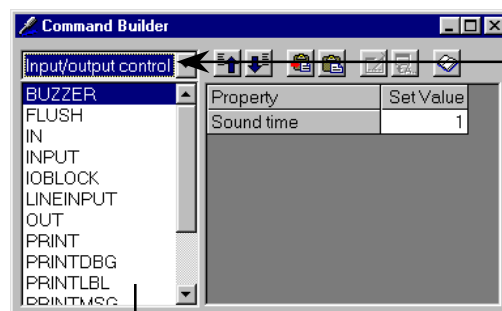

② Click on the [Class Selection] list in the [Command Builder] window and select "Input/output control" statements from the list.

Command list

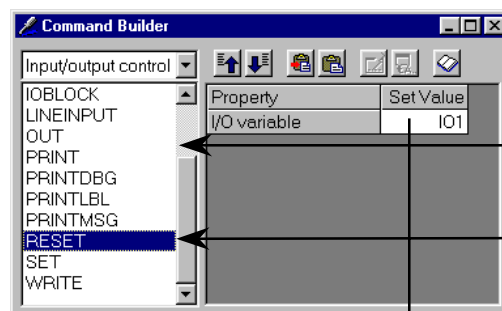

③ Using the scroll bar in the Input/output control statements, scroll down to display the [RESET] command.

④ Click on the [RESET] command.

⑤ Double click on the [I/O variable] Set Value box.

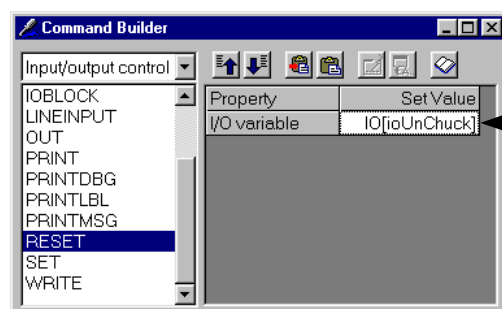

⑥ Type "ioUnChuck" in the [I/O variable] Set Value box using the keyboard.

```

C:\WINCAPSII\Bin\IRA-0000\PRO1.pac
*==== Parts chuck ====
*ChuckItem:
SET IO[ioChuck]
RETURN
*==== Parts unchuck ====
*UnchuckItem:
RESET IO[ioChuck]
SET IO[ioUnChuck]

```

⑦ In the program edit window, click on the position where you want to enter commands.

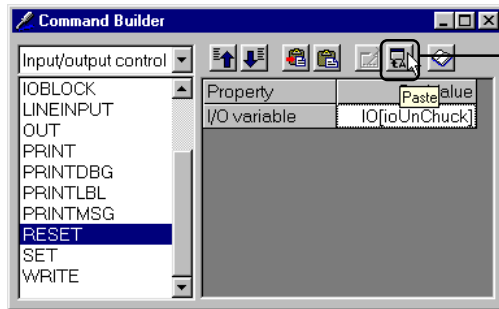

⑧ Click on the [Paste] button .

Step 3

Editing program codes for ease of clarity

```

C:\WINCAPSII\Bin\IRA-0000\PRO1.pac
*!TITLE "Pick & Place"
#include "dio_tab.h"      'Reads the DIO
#include "var_tab.h"     'Reads the vari

PROGRAM pro1
  TAKEARM                'Acquires arm s
  SET IO[ioComplate]
  MOVE P, P[pHome], S=50 'PTP control to
  SPEED 100              'Changes to 100
  APPROACH P,P[pPick],200

```

★Caution★

To save the edited program, proceed to the procedure described in the following section "6.5 Saving the program".

6.5 Saving the program

In this section, you will save PRO1, the program created in the previous section "6.4 Using the command builder".

Step 1

Selecting [Save]

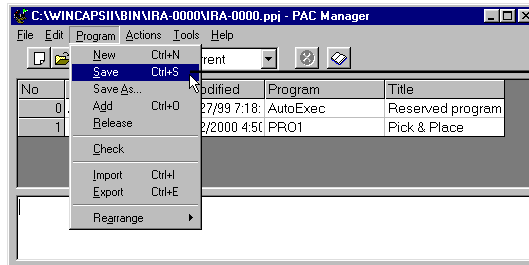

① Select [Save] from the [Program] menu.

Step 2

Entering the file name

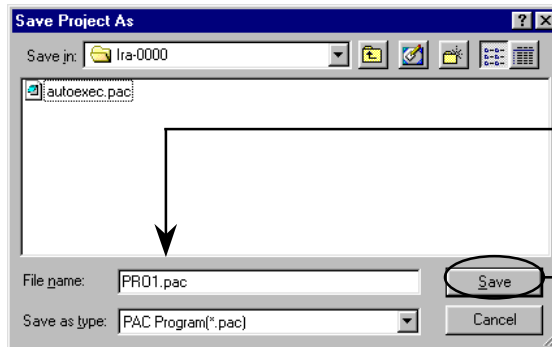

② Enter the file name in the [File name] box.
In this example, enter "pro1" as the file name.
(The extension is attached automatically.)

③ Click [Save]. The program source file "pro1.pac" is saved.

The file name of the [PAC Manager] window changes to "pro1.pac". This completes the inputting and saving procedure of program "pro1".

Lesson 7 Compiling the Program into Run-time Format

To execute a program written in PAC language, it is necessary to convert (compile) it into run-time format so it is executable by the robot controller. The compiled program is referred to as an execution program.

Step 1 Compiling the program into run-time format

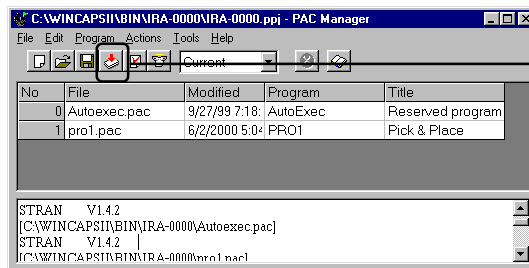

① Click on the [Make Exec. Program] button .

All the programs included in the currently selected project are converted to execution programs. The record of the compiling process is displayed in the message pane of the [DensoPacManager] window.

Step 2 Checking that no error has occurred

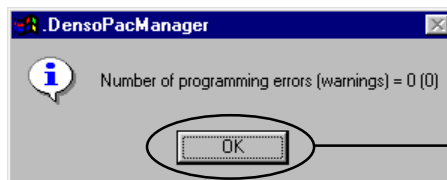

② Check that "Number of programming errors (warnings) = 0 (0)" is displayed and click [OK].

If an error is showing, return to "Lesson 6 Inputting and Editing Programs" and check for syntax errors.

Lesson 8 Uploading the Program (PC → Robot controller)

At present, the execution program compiled in Lesson 7 is still in the PC. To run the program, it is necessary to transmit (upload) it to the robot controller.

Since you have already made communications settings on both the robot controller and PC in Lesson 3.3 and Lesson 4.3, respectively, you may now upload the program to the robot controller.

Step 1

Establishing communications link between the Program Manager and robot controller

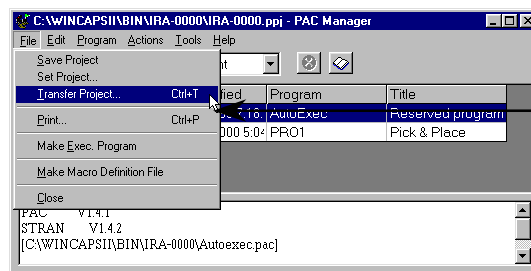

① From the File menu, select [Transfer Project.]

Step 2

Selecting the program to be uploaded

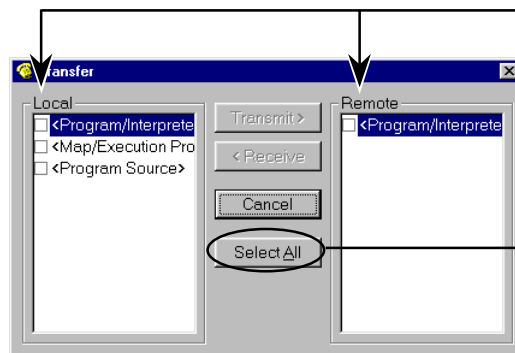

"Local" refers to the PC side and "Remote" to the robot controller side.

② Click on [Select All].

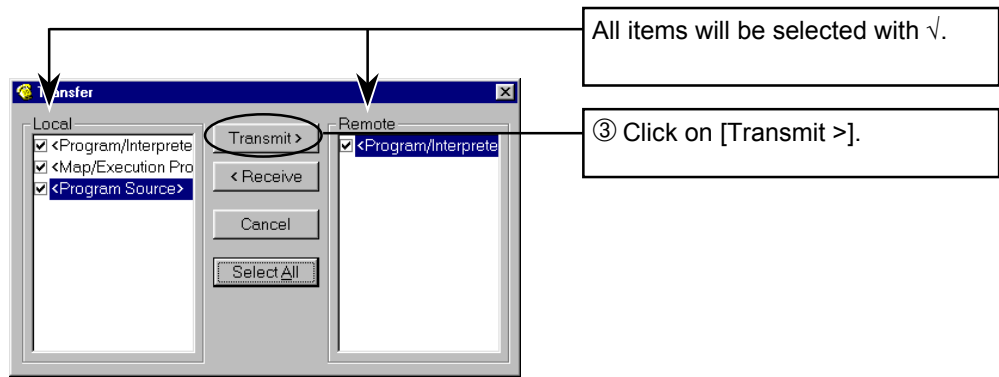

Step 3

Uploading the selected program

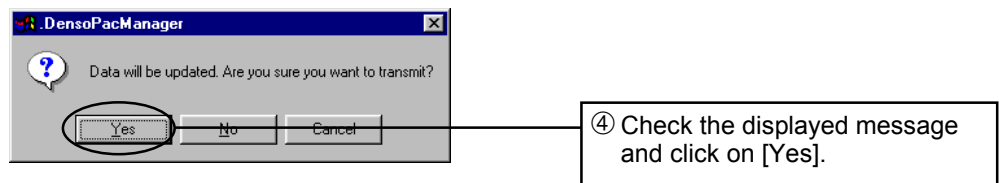

The program file is now uploaded to the robot controller.

Part 3 Simulating the Robot Motion on a PC with the Program Created

In Part 3, you will:

Run the program, which you have created on a PC and uploaded to the robot controller, in machine lock in order to simulate the robot motion on the PC screen.

Simulation allows you to verify the program before actually running the robot, helping you improve safety and the efficiency of program development.

▶ Lesson 9	Preparing the PC for Simulation	67
9.1	Starting Arm Manager	67
9.2	Establishing the communications link with the robot controller in Arm Manager	67
▶ Lesson 10	Assigning the Current Position Values to Position Variables	68
10.1	Simulating robot motion manually	68
10.2	Getting the current position into a position variable	70
10.3	Editing position variables	76
▶ Lesson 11	Test-running the Program	77
11.1	Loading the program	77
11.2	Starting the program	79
▶ Lesson 12	Monitoring and Manipulating the I/Os	80
12.1	Starting DIO Manager and establishing the communications link with the robot controller	80
12.2	Monitoring the I/Os	81
12.3	Turning the I/O dummy switches ON/OFF	82
▶ Lesson 13	Monitoring and Manipulating Variables	83
13.1	Starting the variable manager and connecting communications	83
13.2	Monitoring variables	84
▶ Lesson 14	Continuous Run for Testing	85
14.1	Continuous run	85
14.2	Continuous monitoring of the I/Os	86
14.3	Stopping the running program	88

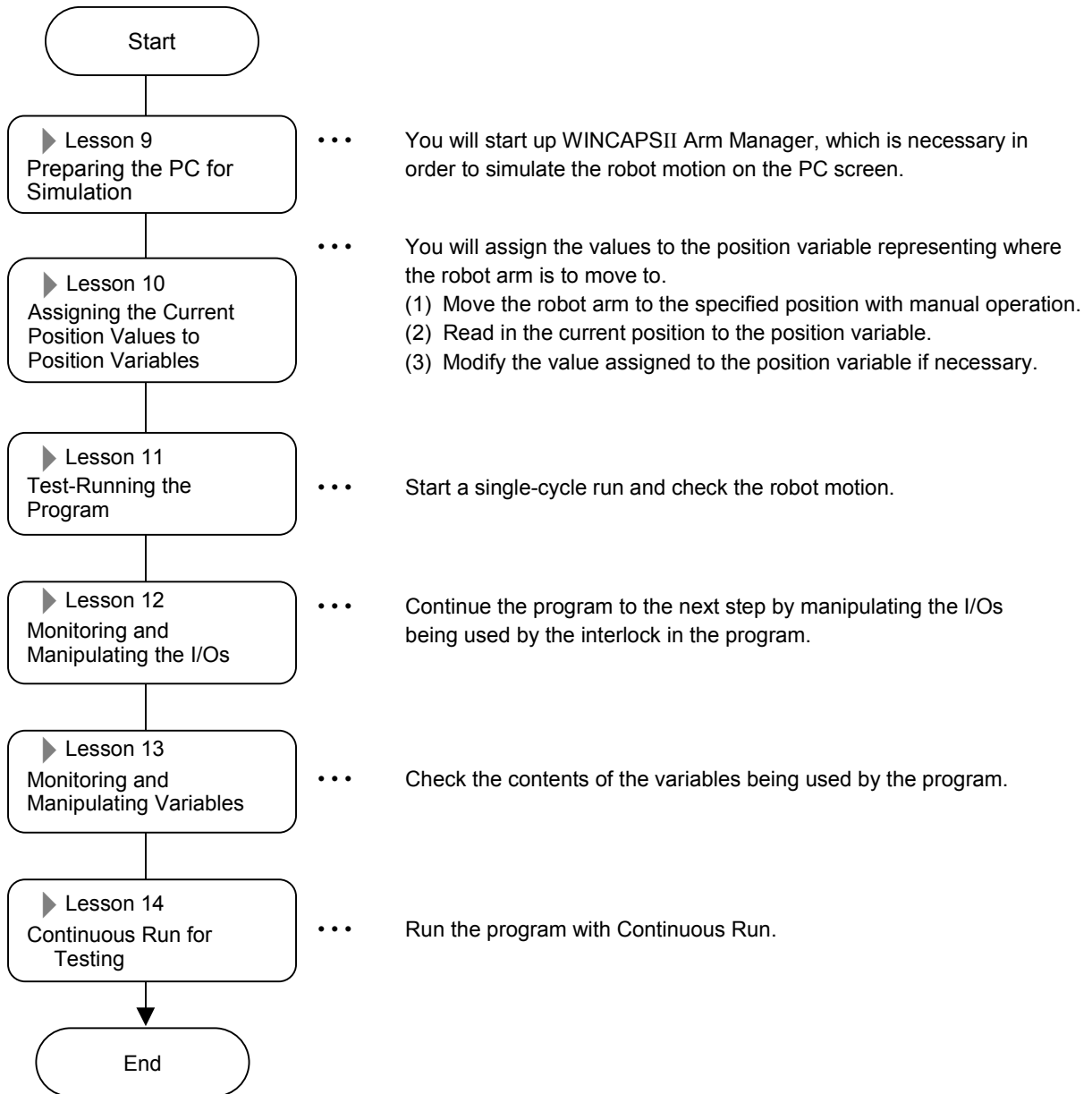

Lesson 9 Preparing the PC for Simulation

You will start Arm Manager and establish the communications link with the robot controller.

9.1 Starting Arm Manager

You need to start Arm Manager in order to display the simulated robot images. The Arm Manager is called up from the System Manager.

Step 1



① Click the [Arm] button.

9.2 Establishing the communications link with the robot controller in Arm Manager

You establish the communications link with the robot controller so that the PC may always exchange data with the robot controller

Step 1

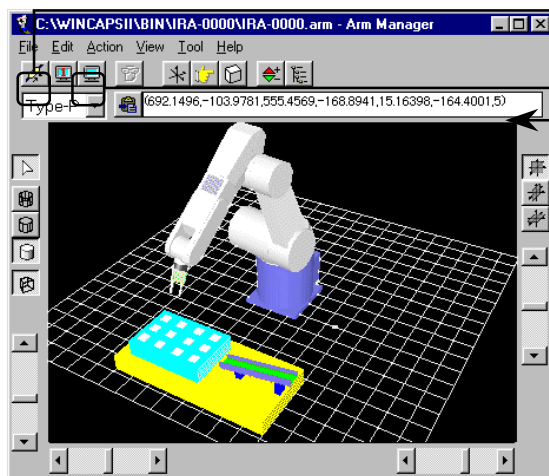

① Click on the [Connect] button.
(The [Connect] button appears depressed.)

② Click on the [Monitor] button.
(The [Monitor] button appears depressed.)

The communications link is established between Arm Manager and the robot controller, enabling data exchange between them.

The current robot position is displayed in the [Current Robot Position] window.

Lesson 10 Assigning the Current Position Values to Position Variables

Before running the program, it is necessary to determine the values to be assigned to the respective position variables "pHome", "pPick", "pPlace1" and "pPlace2" for the program which you created in "Lesson 6 Entering and Editing Programs" of Part 2 "Creating a Program on a PC in WINCAPSI".

In this lesson you will enter the values from the teach pendant through "Point Teaching".

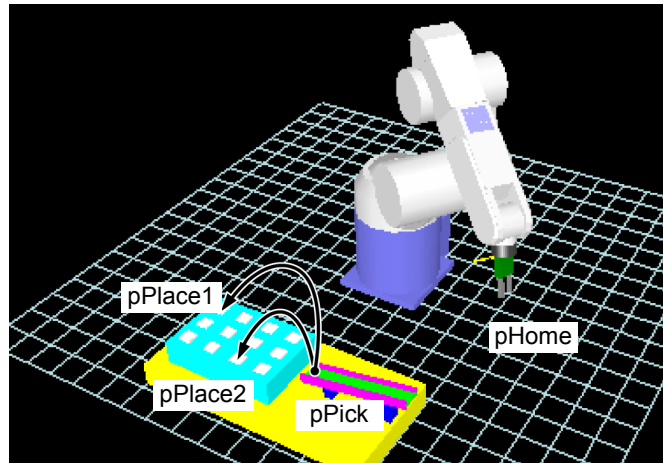

★**Caution**★ Refer to "Lesson 5 Defining Macros" for each of the position variable numbers for "pHome", "pPick", "pPlace1" and "pPlace2".

10.1 Simulating the robot motion manually

While monitoring the simulation images displayed in Arm Manager, move the robot arm manually to the position values assigned to the "pHome" position variable, according to the procedure given below.

Step 1

Placing the robot in Manual mode and displaying the current robot position

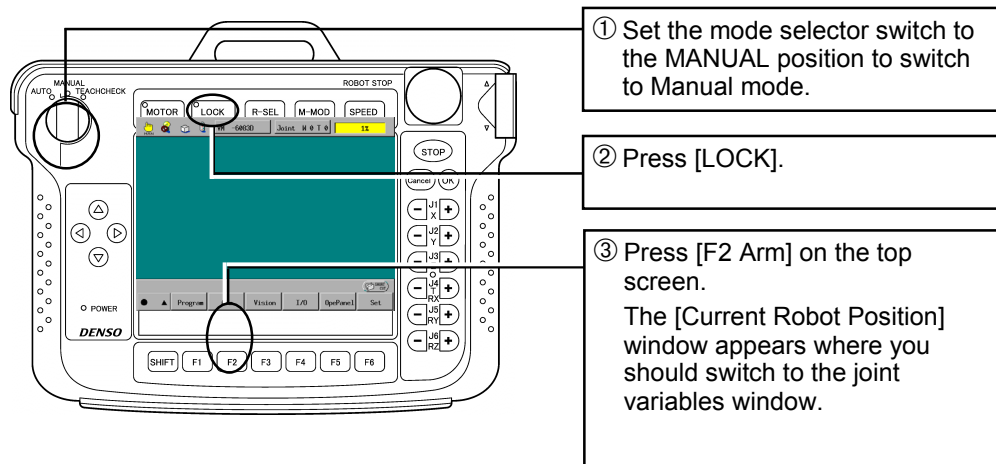

Step 2

Moving the robot arm

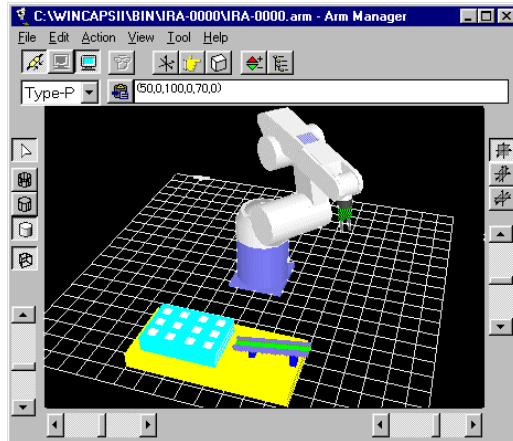

④ While monitoring the robot simulation image, move the robot arm to "pHome" using the deadman switch and the arm traverse keys so that the following values will apply:

- J1: Approx. 40°
- J2: 0° (no move)
- J3: Approx. 100°
- J4: 0° (no move)
- J5: Approx. 70°
- J6: 0° (no move)

Step 3

Checking the current position

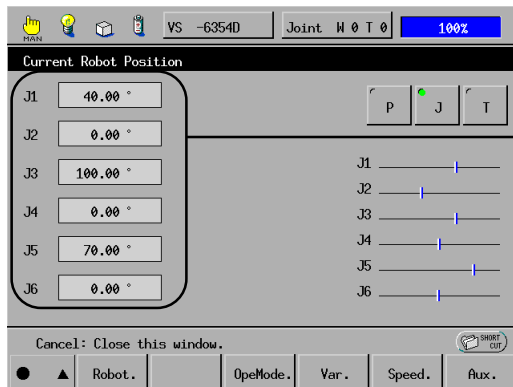

⑤ Check the position of each axis in the [Current Robot Position] window.

10.2 Getting the current position into a position variable

Let's get the current position, to which the robot arm has moved in Arm Manager, into a position variable.

There are the following three ways to get the current position into a position variable:

- [1] Using the [Position Variables] window on the teach pendant
- [2] Using the program edit window (coding list) on the teach pendant, in which you get the current position into a position variable defined in the specified program
- [3] Using the operating panel

[1] Using the [Position Variables] window on the teach pendant

Step 1

Calling up the [Position Variables] window

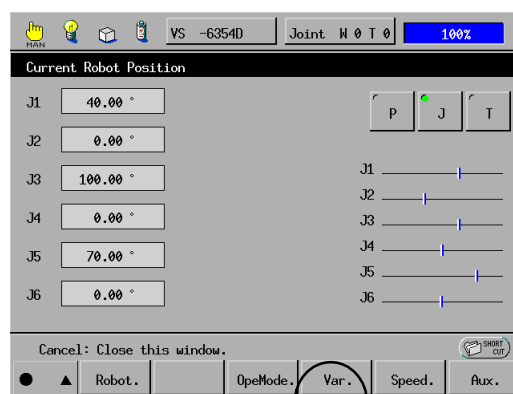

① Press [F4 Var.] with the [Current Robot Position] window displayed.

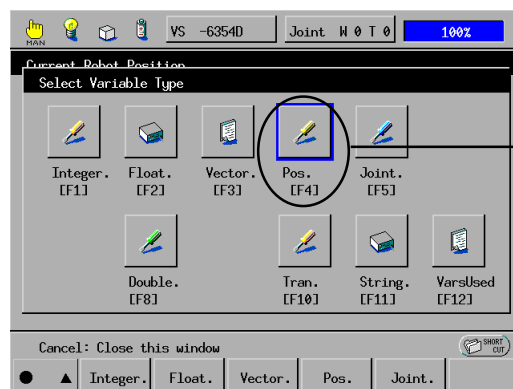

② On the [Select Variable Type] window, press [F4 Pos.].

F4

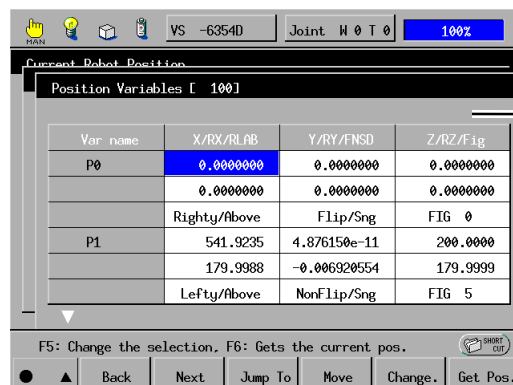

The [Position Variables] window appears.

Step 2

Getting the current position into a position variable

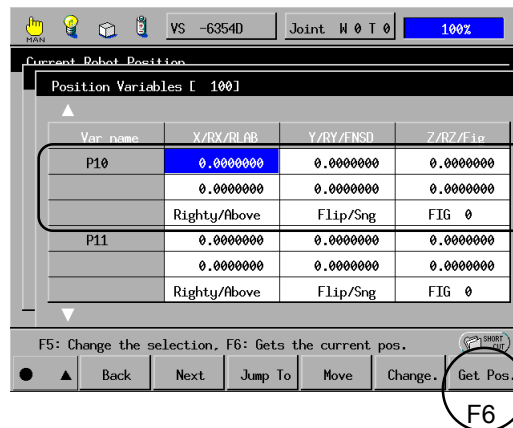

③ Using the jog dial or cursor keys, select "P10" box.

④ Press [F6 Get Pos.].

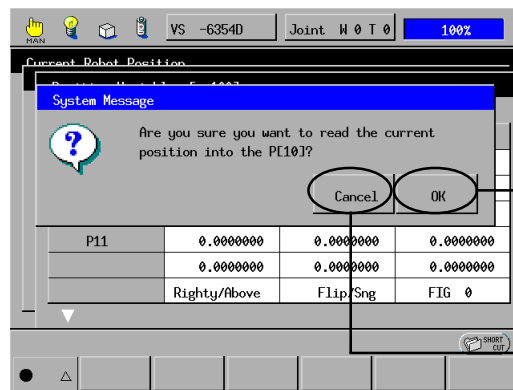

⑤ Press [OK].
This gets the current position of the robot arm into position variable P[10].

⑥ Press [Cancel] twice.
The display returns to the [Robot Current Position] window.

⑦ Go back to Step 2 "Moving the robot arm" in Lesson 10.1.

Step 3

Getting other arm positions into position variables

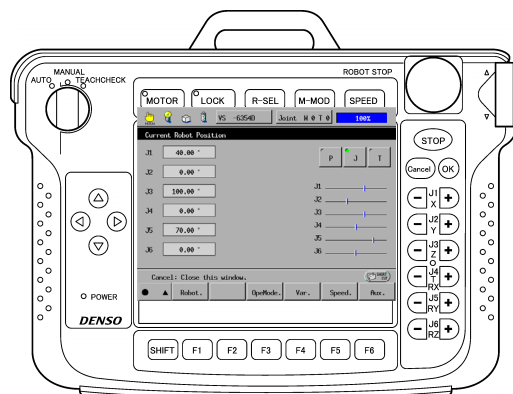

As in Steps 1 and 2, get other arm positions.

[2] Using the program edit window (coding list) on the teach pendant, in which you get the current position into a position variable defined in the specified program

Step 1 Calling up the Program List window

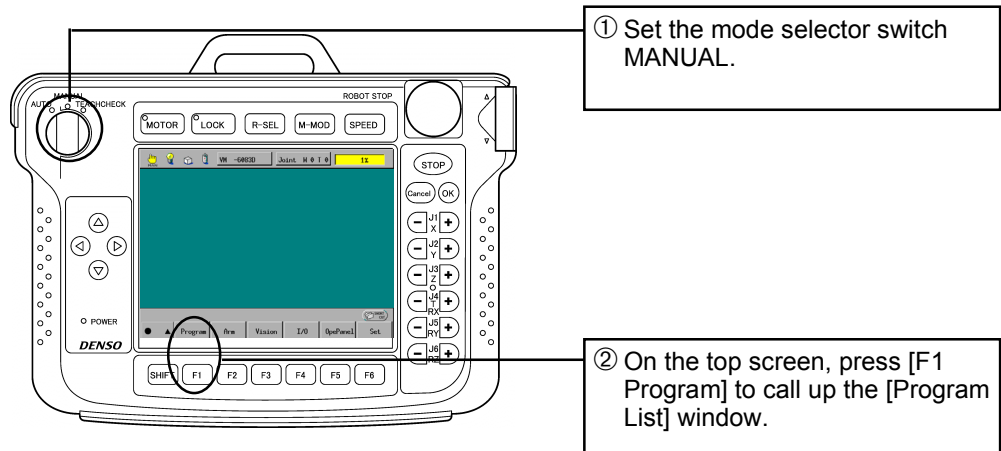

Step 2 Selecting the target program

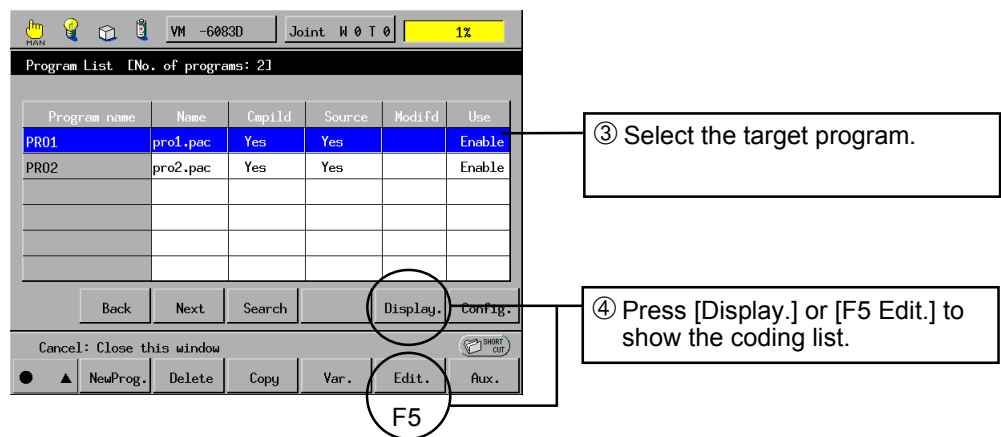

Step 3 Selecting the program line containing the target variable

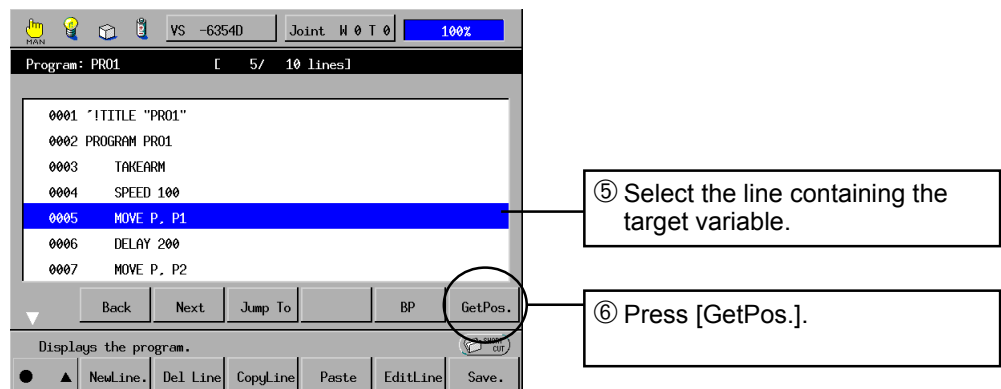

Step 4

Getting the current position into a variable contained in the line

If the program line contains a single variable candidate, the system message will appear as shown below.

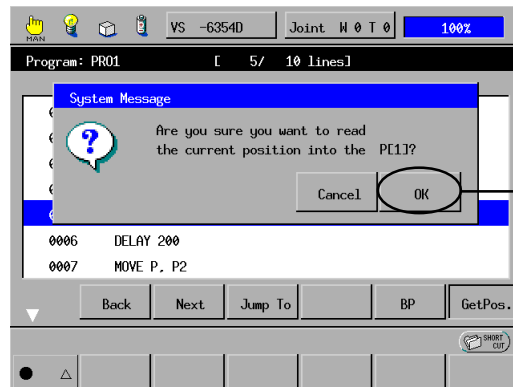

⑦ Press [OK]. This gets the current position into the variable.

If the program line contains more than one variable candidate, the system message will appear as shown below. Select the desired variable.

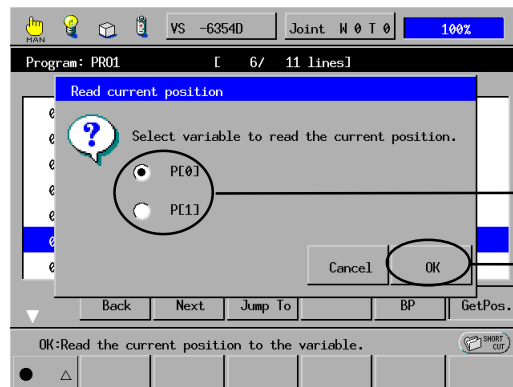

⑧ Select the desired variable by using the cursor keys or jog dial.

⑨ Press [OK]. This gets the current position into the selected variable.

If a variable(s) contained in the selected program line is not appropriate, no variable will be displayed as a candidate for teaching.

Only the heading three variables in the program line will be displayed as a candidate.

[3] Using the operating panel

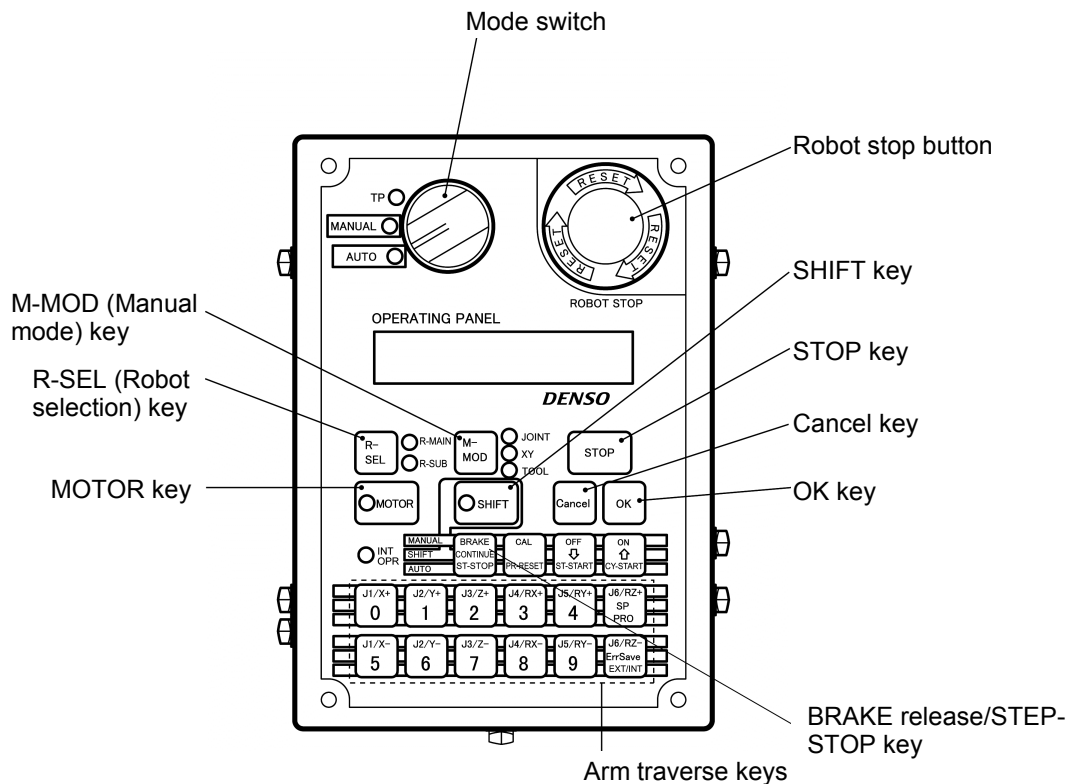

Step 1 Switching to the Manual mode

Turn the mode switch to the MANUAL position and check that its LED comes on.

Step 2 Entering the function selection mode

Press the SHIFT key and check that its LED comes on.

Then press the BRAKE release/STEP-STOP key to make the operating panel enter the function selection mode.

Step 3 Choosing the get-position function

Use the \uparrow and \downarrow cursor keys to choose the desired function.

To get the current position into: _____ Choose: _____

Position variable	[F7: Set CurPos P]
Joint variable	[F8: Set CurPos J]
Trans. variable	[F9: Set CurPos T]

After choosing the desired function, press the OK key.

Step 4 **Choosing a target variable number**

Use the numerical keys to enter a variable number into which you want to get the current position.

Press the OK key. (To cancel the number you entered, press the Cancel key. The LCD returns to Step 3.)

Step 5 **Getting the current position**

The LCD shows [SetCurrentPos?].

Press the OK key. (To cancel the operation, press the Cancel key. The LCD returns to Step 4.)

Upon completion of getting of the current position, the LCD shows [Set VarVal OK].

10.3 Editing position variables

You may edit position variables as required. As a simple example, you will modify the value assigned to a position variable.

The teach pendant displays the Position Variables window as shown below.

Step 1

Selecting Position Variables

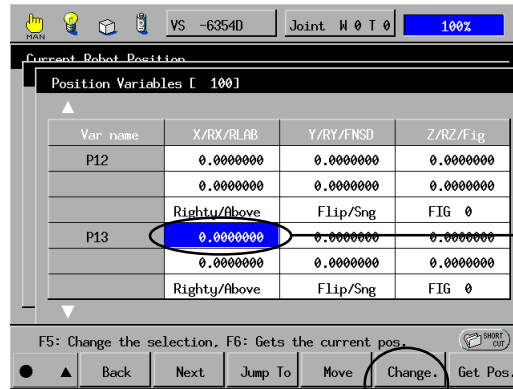

① Using the jog dial or the cursor keys, select the [X] column of position variable "P13".

② Press [F5 Change.].
The numeric keypad appears as shown below.

Step 2

Modifying the value assigned to "P12"

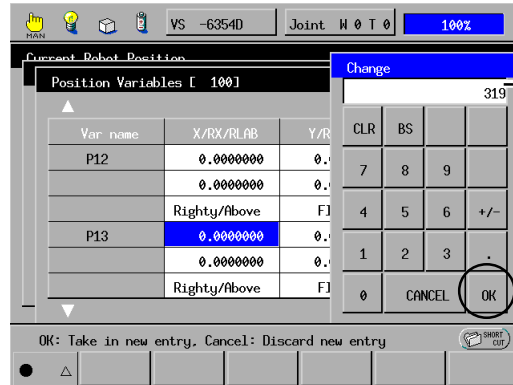

① Using the numerical keys on the numeric keypad, enter a new value.
As an error will result if you enter too different a value, enter "319" which is close to the original value.

② Press [OK].
"319" is entered into the [X/T] column of position variable "P13".

Returning to the top screen

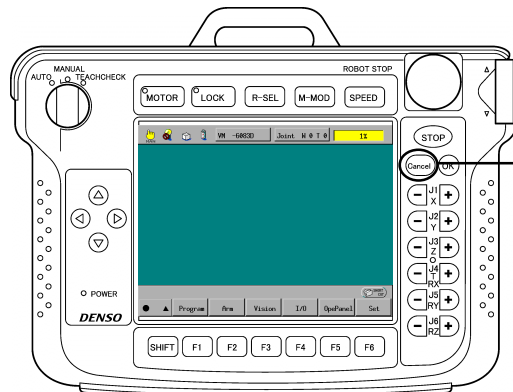

③ Press [Cancel] 3 times to return to the top screen.
This completes the editing of position variables.

Lesson 11 Test-running the Program

You will test-run program "PRO1" by a single-cycle run.

11.1 Loading the program

Even if you load a compiled program from the PC to the robot controller, the controller cannot execute it. The program needs to be loaded to the memory area where it can be executed.

Step 1 Displaying the load screen

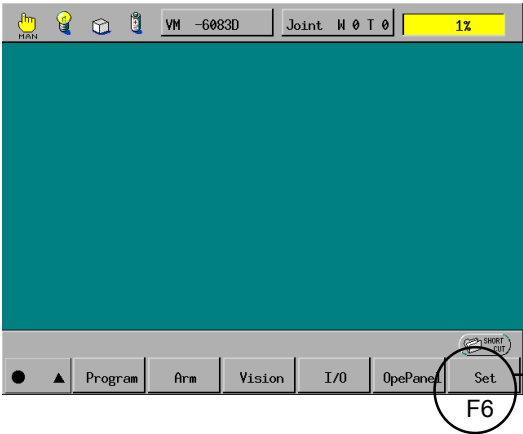

① Press [F6 Set] on the top screen.

Step 2 Loading the project

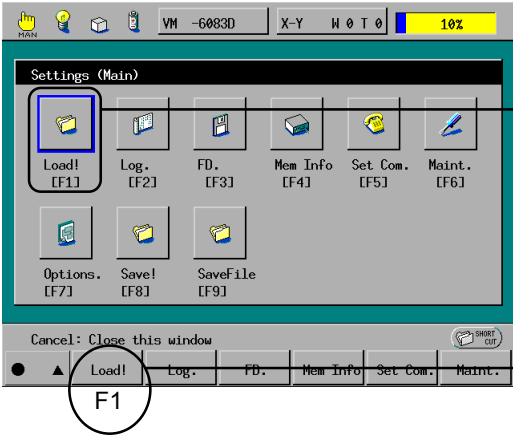

② Press either the [F1 Load!] button or [Load!].

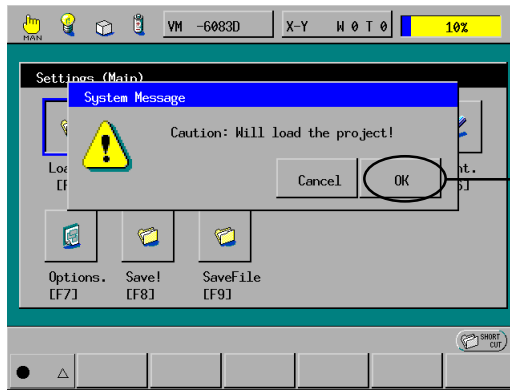

③ Check the system message and press [OK].

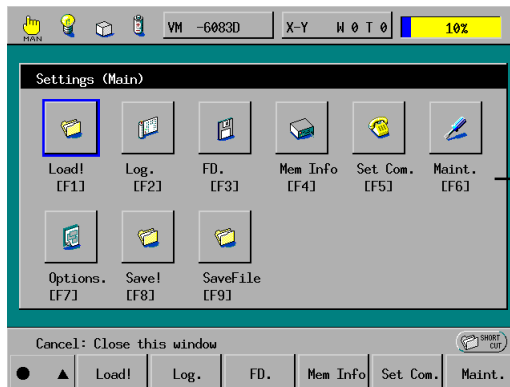

Upon completion of loading, the screen returns to the [Setting (Main)] window.

Returning to the top screen

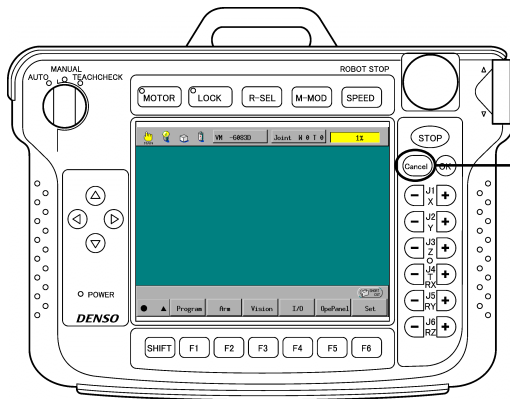

⑤ Press [Cancel] to return to the top screen.

11.2 Starting the program

Now you will place the robot controller in machine lock and start the loaded program by a single-cycle run in order to simulate the robot motion on the PC screen.

The program will come to a halt and wait for part supply confirmation I/O signals; however, proceed to the following step as you will manipulate I/Os in Lesson 12.

Step 1

Displaying the Program List window in Teach Check mode

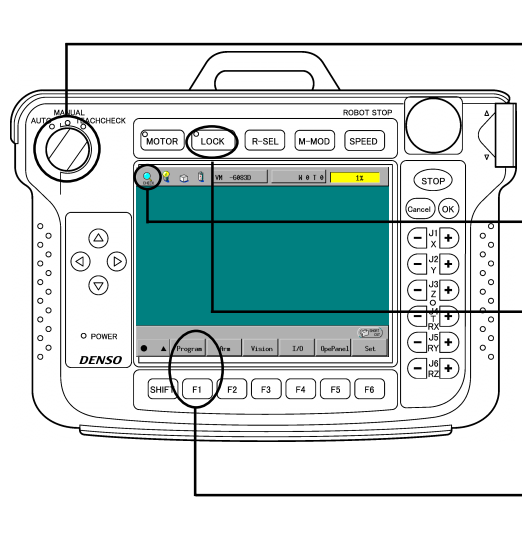

① Set the mode selector switch to TEACHCHECK.
(The robot controller enters the Teach Check mode.)

② Check that the mode icon at the top left of the screen has changed to [CHECK].

③ Press [LOCK] to place the robot in machine lock. Check that the [LOCK] LED has come on.

④ Press [F1 Program] to display the [Program List] window.

Step 2

Selecting the program to start it

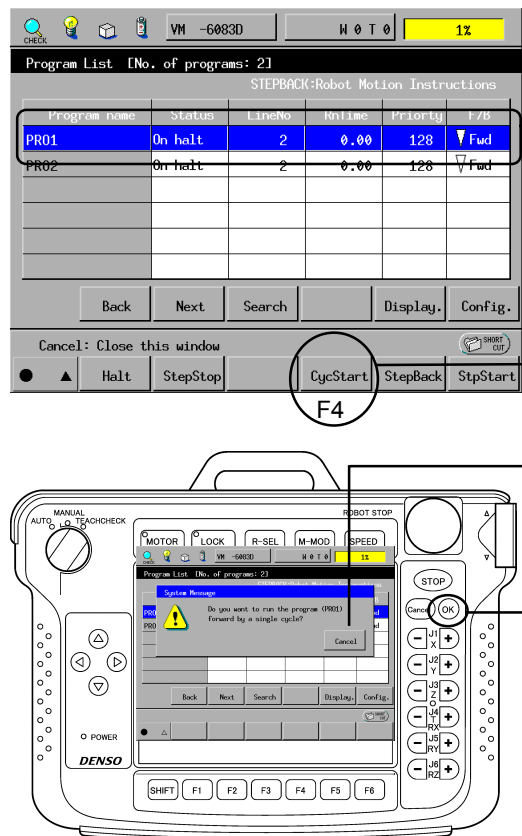

Program Name	Status	LineNo	RunTime	Priority	F/B
PRO1	On halt	2	0.00	128	Fwd
PRO2	On halt	2	0.00	128	Fwd

⑤ Select the "PRO1" line.

⑥ Press [F4 CycStart].

⑦ Check the system message.

⑧ Press [OK].
"PRO1" runs a single-cycle.

Lesson 12 Monitoring and Manipulating the I/Os

Cycle-started program "PRO1" is now on halt, waiting for the macro I/O "ioParts" for confirming parts supply.

In this lesson, to test the program, you will use the I/O Manager for monitoring and manipulating the I/Os to continue program execution.

Note: Refer to "Lesson 5 Defining Macros" for the I/O numbers of "ioParts".

12.1 Starting the DIO Manager and establishing the communications link with the robot controller

You will start the DIO Manager and establish the communications link with the robot controller so that the PC may always exchange data with the robot controller.

Step 1

Starting the DIO Manager



① Click on the [I/O] button in the System Manager window. The [DIO Manager] window appears.

Step 2

Connecting with the robot controller to start continuous monitoring

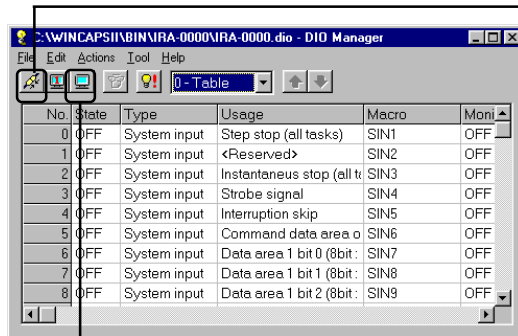

② Click the [Connect] button in the DIO Manager window. The [Connect] button appears depressed.

③ Click on the [Monitor] button. The communications link is established between the DIO Manager and robot controller, enabling data exchange between them. The [Monitor] button appears depressed.

12.2 Monitoring the I/Os

You will monitor the I/Os with the DIO Manager.

The DIO Manager can show the I/O status in three types of display formats--table type, oscilloscope type, and panel type. In this lesson, use the table type display to check "ioParts" on I/O No. 34.

The table type display is just like a list and appears initially when you open the [DIO Manager] window. If the display is in any other display type, select the table type from the [Variable Scope] list.

Step 1

Displaying the I/Os

No.	Type	Usage	Macro	Monitor	Dump
34	User input	parts supply signal	ioParts	ON	ON
35	User input	motion complete sign	ioComplete	OFF	ON
36	User input		UIN3	OFF	ON
37	User input		UIN4	OFF	ON
38	User input		UIN5	OFF	ON
39	User input		UIN6	OFF	ON
40	User input		UIN7	OFF	ON
41	User input		UIN8	OFF	ON
42	User input		UIN9	OFF	ON

① Scroll down the [DIO Manager] window to display I/O No. 34. (Use the scroll bar at the right side of the window to scroll.)

Step 2

Setting the monitor type

No.	Type	Usage	Macro	Monitor	Dump
34	User input	parts supply signal	ioParts	ON	ON
35	User input	motion complete sign	ioComplete	OFF	ON
36	User input		UIN3	OFF	ON
37	User input		UIN4	OFF	ON
38	User input		UIN5	OFF	ON
39	User input		UIN6	OFF	ON
40	User input		UIN7	OFF	ON
41	User input		UIN8	OFF	ON
42	User input		UIN9	OFF	ON

② Click the [Continuous Monitor] button in the [DIO Manager] window to set the monitor to OFF. (It is not possible to change the set contents while the monitor is set to ON.)

③ Double-click on the [Monitor] box of I/O No. 34 that is displayed in the DIO Manager window.
The setting in the [Monitor] box changes from "OFF" to "ON" making it now possible to monitor I/O No. 34.

④ Click on the [Continuous Monitor] button to set the monitor to ON.
The "State" of I/O No. 34 is displayed as "ON" or "OFF", according to the changes made to the I/O.
In this example, the "ioParts" for I/O No. 34 is displayed as "OFF".

12.3 Turning the I/O dummy switches ON/OFF

In DIO Manager, you may falsely turn the I/Os on or off.

The program PRO1 "PICK & PLACE" is waiting for I/O No. 34 "ioParts" to turn ON and will not proceed to the next step in this status. By managing the I/O falsely, you may perform the operation test.

Step 1

Stopping monitoring

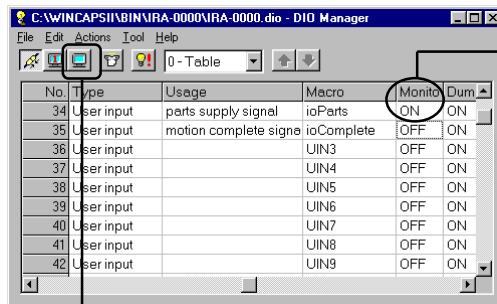

No.	Type	Usage	Macro	Monitor	Dum
34	User input	parts supply signal	ioParts	ON	ON
35	User input	motion complete signal	ioComplete	OFF	ON
36	User input		UIN3	OFF	ON
37	User input		UIN4	OFF	ON
38	User input		UIN5	OFF	ON
39	User input		UIN6	OFF	ON
40	User input		UIN7	OFF	ON
41	User input		UIN8	OFF	ON
42	User input		UIN9	OFF	ON

① In the [DIO Manager] window, check that the [Monitor] box for I/O No. 34 is set to "ON".

② Click here to set the [Continuous Monitor] to "OFF".

Step 2

Setting the dummy switch

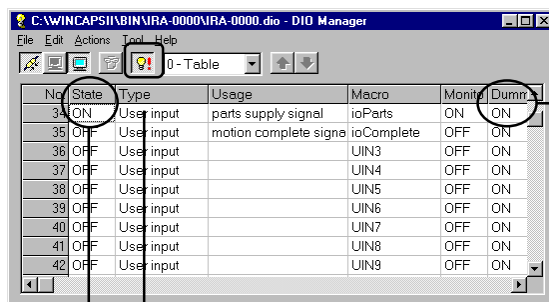

No.	State	Type	Usage	Macro	Monitor	Dummy SW
34	ON	User input	parts supply signal	ioParts	ON	ON
35	OFF	User input	motion complete signal	ioComplete	OFF	ON
36	OFF	User input		UIN3	OFF	ON
37	OFF	User input		UIN4	OFF	ON
38	OFF	User input		UIN5	OFF	ON
39	OFF	User input		UIN6	OFF	ON
40	OFF	User input		UIN7	OFF	ON
41	OFF	User input		UIN8	OFF	ON
42	OFF	User input		UIN9	OFF	ON

③ Double-click the [Dummy SW] box of I/O No. 34 in the [DIO Manager] window to set it "ON".

④ To enable the dummy I/O:
Click the [Dummy I/O] button in the DIO Manager window.
The [Dummy I/O] button appears depressed.

⑤ Double-click the [State] box of I/O No. 34 to set it "ON".

The program recognizes I/O No. 34 "ioParts" as being "ON", so it proceeds onto the next step. If no problem is detected, the program will run through to the end and stop.

Lesson 13 Monitoring and Manipulating Variables

The Variable Manager allows you to monitor variables.

In this lesson, you will examine the integer variable [0] of macro "iParts", which is used in the operation count.

NOTE: Refer to "Lesson 5 Defining Macros" for the variable number 0 of "ioParts".

13.1 Starting the Variable Manager and establishing the communications link with the robot controller

Start the Variable Manager and connect communications so that data exchange is constantly performed with the robot controller.

Step 1

Start the Variable Manager



① Click on the Variable button in the [System Manager] window.

Step 2

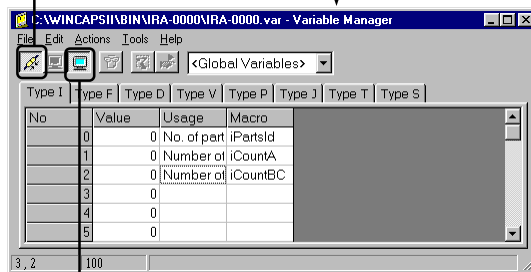

The [Variable Manager] window appears.

② Click on the [Connect] button to establish the communications link with the robot controller. The [Connect] button appears depressed.

③ Click on the [Continuous Monitor] button to start continuous monitor. The [Continuous Monitor] button appears depressed.

The above process has established the communications link so that the PC may always exchange data with the robot controller.

13.2 Monitoring variables

Establishing the communications link with the robot controller allows you to monitor the variables used in the robot controller.

Step 1

Displaying the variables

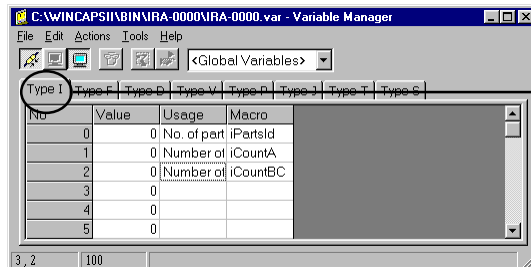

The screenshot shows a window titled "C:\WINCAPS\BIN\MIRA-0000\MIRA-0000.var - Variable Manager". The window has a menu bar with "File", "Edit", "Actions", "Tools", and "Help". Below the menu bar is a toolbar with several icons. A dropdown menu is open, showing "<Global Variables>". Below the dropdown is a row of tabs labeled "Type I", "Type F", "Type D", "Type V", "Type P", "Type J", "Type T", and "Type S". The "Type I" tab is selected. The main area of the window contains a table with the following data:

No	Value	Usage	Macro
0	0	No. of part	iPartsId
1	0	Number of	iCountA
2	0	Number of	iCountBC
3	0		
4	0		
5	0		

At the bottom of the window, there is a status bar showing "3, 2" and "100".

① Scroll down the [Variable Manager] window to display integer variable [0].
To do so, use the scroll bar at the right side of the window.

The [Value] column for integer variable [0] reflects the changes made to the variable.

Lesson 14 Continuous Run for Testing

Up to the previous lesson, you have checked the PRO1 with a single-cycle run.

Continuous run makes the robot perform the programmed motion repeatedly. If I/O No. 34 "ioParts" is kept at ON with the dummy switch, continuous run is possible even if no actual entry is given to I/O No. 34.

Before actually running the robot, place the robot controller in machine lock and conduct a continuous run for testing while monitoring the simulated robot images in the Arm Manager.

Here we will assume that I/O No. 34 "ioParts" remains ON from the preceding section.

14.1 Continuous run

Start the Variable Manager and establish the communications link with the robot controller so that the Variable Manager may always exchange data with the robot controller.

Step 1

Displaying the Program List window in Auto mode

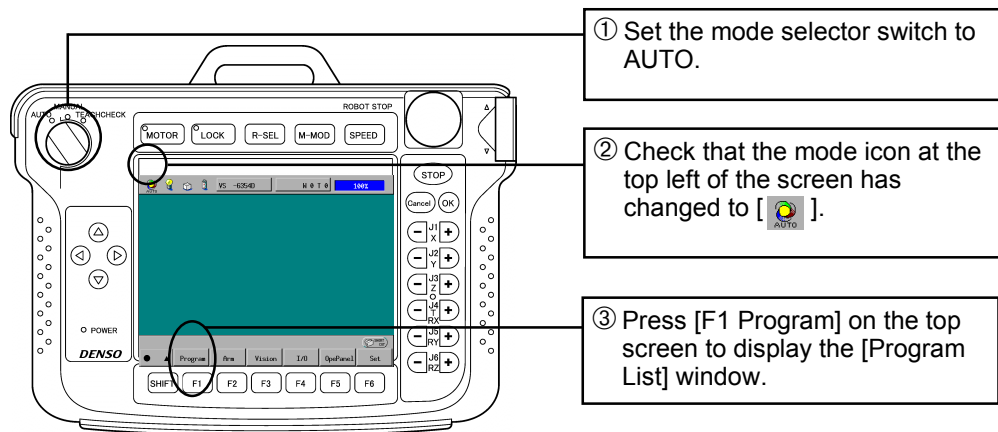

Step 2

Selecting a program to be executed

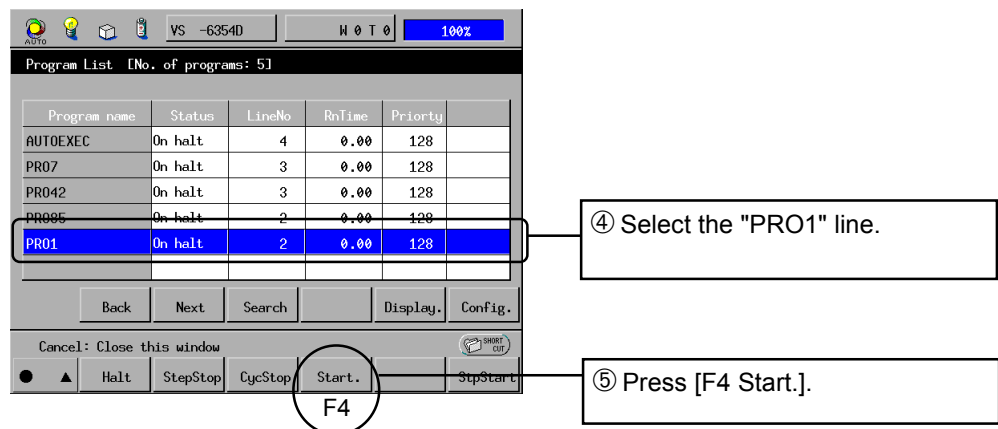

Step 3

Continuous run

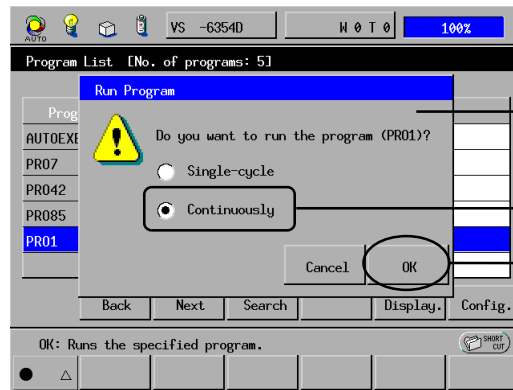

The "Single-cycle" and "Continuously" selection screen appears.

⑥ Select [Continuously] and press [OK].
"PR01" will start a continuous run.

14.2 Continuous monitoring of the I/Os

In this section, you will monitor the I/O status during the continuous run with the DIO Manager.

The DIO Manager has three types of I/O display formats--table type, oscilloscope type, and panel type.

When the [Monitor] button is pressed, the I/O status with the [Monitor] box "ON" is displayed continuously in real time.

You will monitor the I/Os used in the program.

The DIO Manager that was opened in Lesson 13 should have remained open. If closed, however, click on the [Variable] button in the System Manager to start it.

Table Type

The table type I/O display format is similar to the list that initially appears when you open the DIO Manager.

If the display is other than the table type, select the table type from the [Display Switch] list.

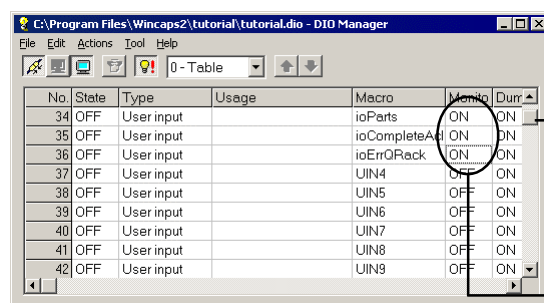

① Scroll down the [DIO Manager] window to display I/O Nos. 34 to 36.
(Use the scroll bar at the right side of the window to scroll.)

② Double-click on the [Monitor] boxes for I/O Nos. 34 to 36 displayed in the [DIO Manager] window to set them to "ON".
The [State] box display changes to "ON" or "OFF" according to the changes made to the I/O.

Oscilloscope Type

You can visually monitor the I/O status with [Monitor] turned "ON" just as you watch an oscilloscope in the table type display of the [DIO Manager] window.

Proceed with the following operation, continuing on from that described in the previous lesson.

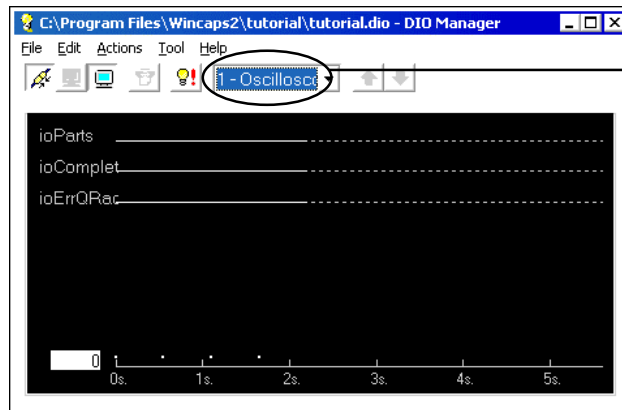

① Click on the ▾ button and select [1 – Oscilloscope] from the list displayed.

The statuses of I/O Nos. 34 to 36 are displayed like an oscilloscope.

② The oscilloscope type display is suitable for examining the changing state of I/O signals with the lapse of time.

Check if each I/O is turned ON or OFF according to the program.

Panel Type

With the DIO Manager, the I/O statuses can also be displayed as a panel type display.

Here you will display the I/O statuses of which the [Monitor] is "ON" in the table type format.

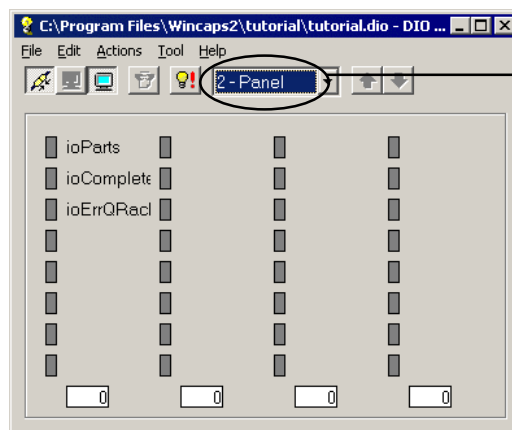

① Click on the ▾ button of the [Display Switch] list and select [2 – Panel] from the list displayed.

The statuses of I/O Nos. 34 to 36 are displayed like an oscilloscope.

② The panel type display is suitable for simultaneously monitoring the changes to the statuses of multiple I/O signals.

Check if each I/O is turned ON or OFF according to the program.

14.3 Stopping the running program

Up to this point, you have checked continuous run of "PRO1". Before continuing onto Part 4, stop the running program.

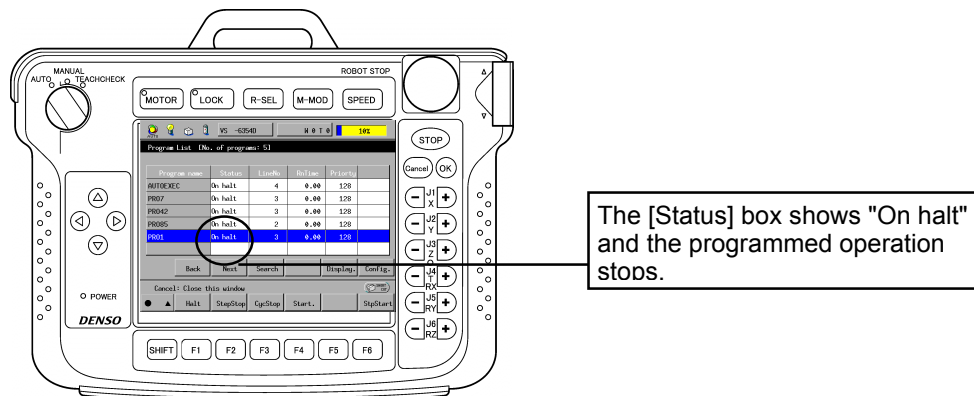
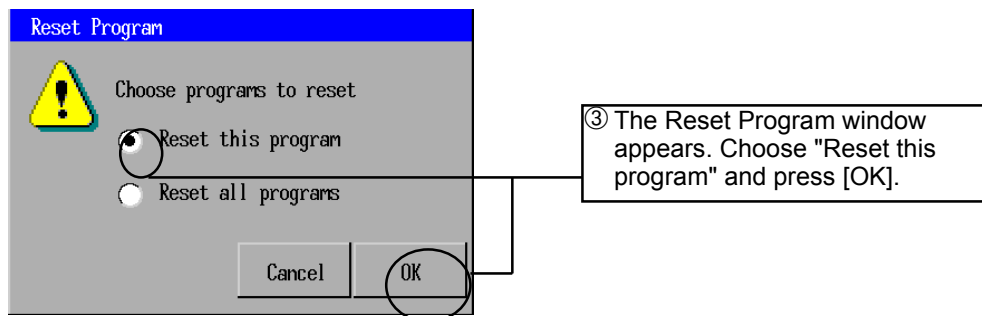
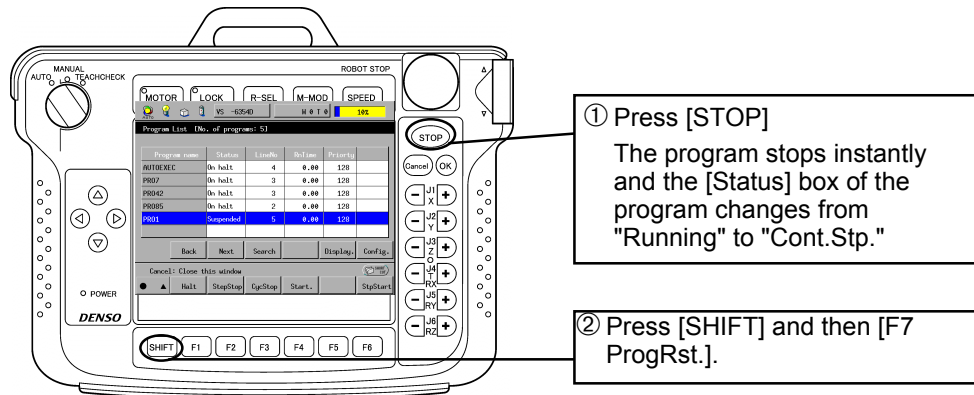

Part 4

Running the Robot Using Programs

In Part 4, you will:

- Run the robot using a program.
- Learn palletizing, which is one of the main applications on 4-axis robots, and related programming.
- Learn how to effectively use PAC libraries, which are the easiest way to develop robot programs.

▶ Lesson15	Running the Robot in Practice	90
15.1	Releasing machine lock	90
15.2	Setting robot speed and acceleration	91
15.3	Turning the drive motor ON	92
15.4	Teaching	93
15.5	Starting programs	96
15.6	Changing the robot speed	97
15.7	Stopping the robot in continuous running	98
■	Making the program [Continue Stop] and [Continue Start]	98
■	Stopping the program completely ([Program Reset])	100
▶ Lesson16	Palletizing	102
16.1	What is palletizing?	102
16.2	Simplified Palletizing	110
▶ Lesson17	Using Libraries Effectively	118
17.1	Program bank	119
17.2	Importing programs	121
▶ Lesson18	Terminating the Session	123
18.1	Terminating WINCAPSII and shutting down the PC	123
18.2	Turning the robot controller OFF	123

Lesson 15 Running the Robot in Practice

You learnt how to check program operation in Parts 1 to 3. In Lesson 15, let's practice running the robot using programs.

First of all, you should perform a safety check. Then set the robot at a low speed and run it slowly to check its motion.

You should also test-run the robot using dummy I/O signals. In this lesson you will connect the actual hardware to the robot controller and check its motion.

Refer to the INSTALLATION & MAINTENANCE GUIDE for details on setting up your hardware.

15.1 Releasing machine lock

Step 1

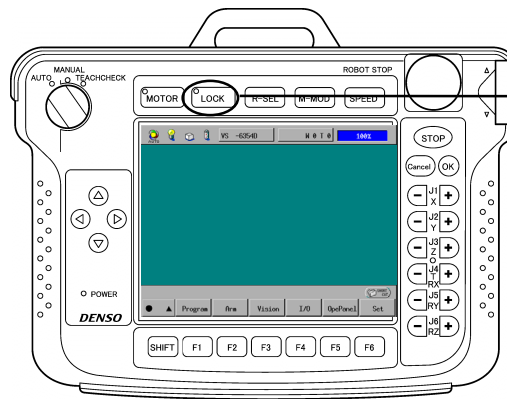

- ① Press [LOCK].
- ② Check that the green LED on the [LOCK] button comes on.

This releases machine lock.

15.2 Setting robot speed and acceleration

Step 1

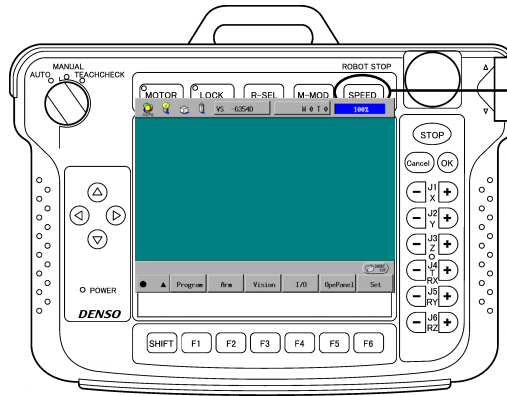

① Press [SPEED].

Step 2

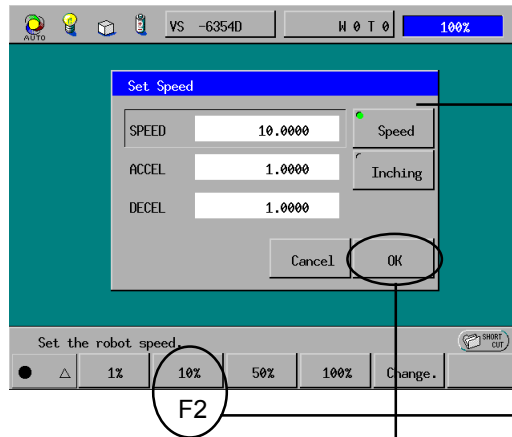

The [Set Speed] window appears.

② Press [F2 10%].

The set values appear in the [SPEED], [ACCEL], and [DECEL] fields.

③ Press [OK] to accept these settings.

This completes the procedure for setting the speed and acceleration of the robot.

15.3 Turning the drive motor ON

Step 1

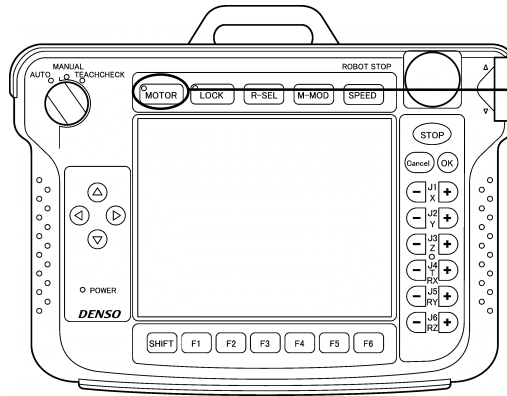

- ① Press [MOTOR].
- ② Check that the LED on the [MOTOR] button comes on.

The power to the motor is now on.

15.4 Teaching

You entered values for the position variable values in Lesson 10 "Entering position variables", but positioning in the Arm Manager will not necessarily be exact. You will need to perform repositioning here by using the robot in practice, and assigning accurate values to the position variables.

You will follow almost same as that described in Lesson 10 "Inputting Values to Position Variables"; however, here you have to enter actual values observing the current robot position and figure, not to seek the position representing the target values.

Step 1 Selecting Manual mode and displaying the current robot position

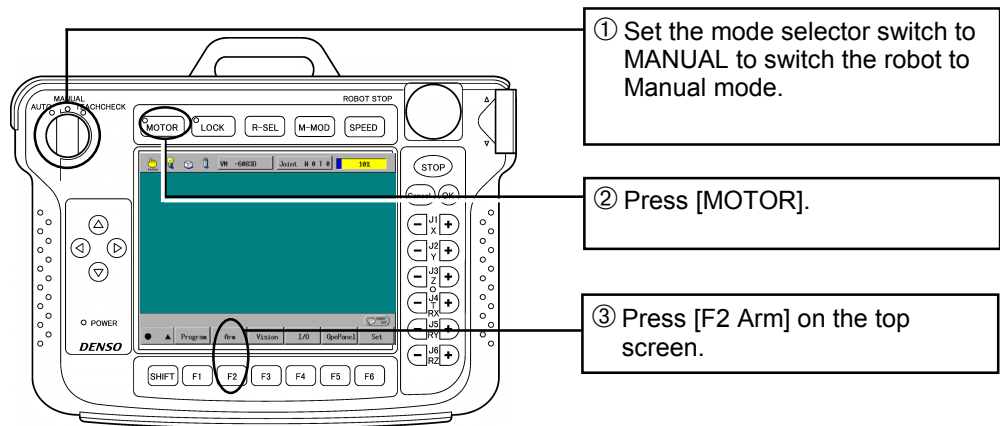

Step 2 Moving the robot arm

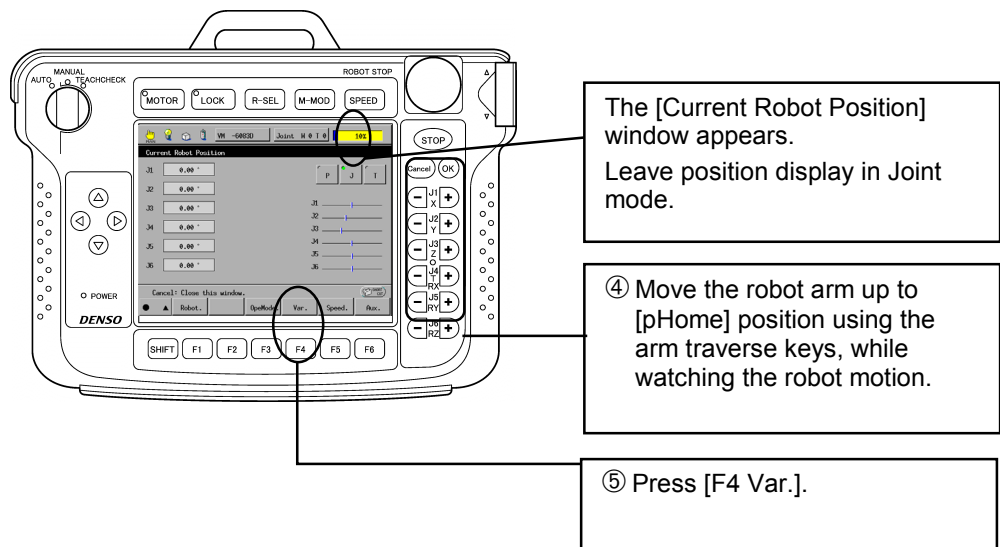

Step 3 Displaying position variables

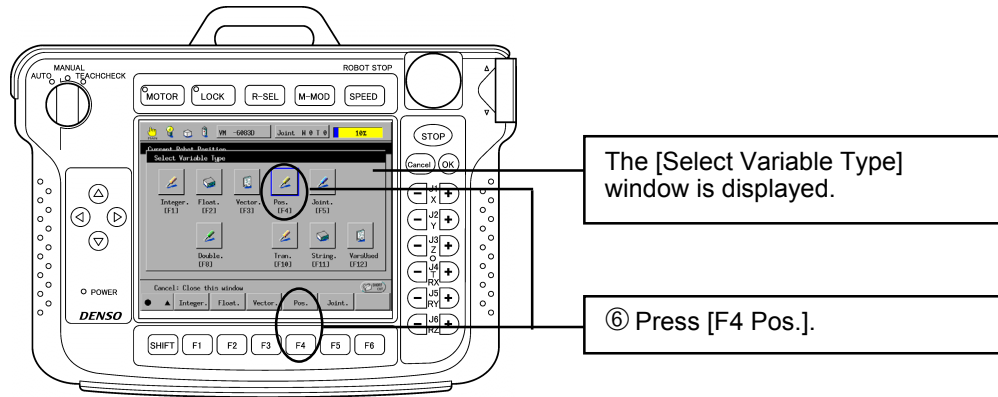

Step 4 Getting the current robot position into position variables

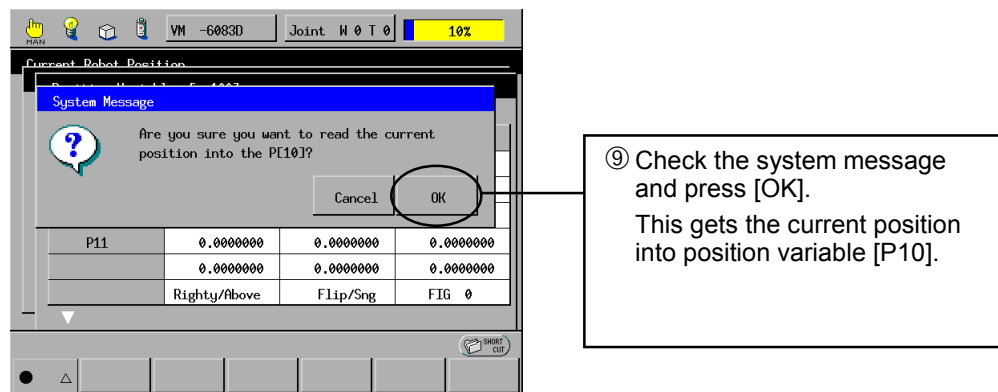
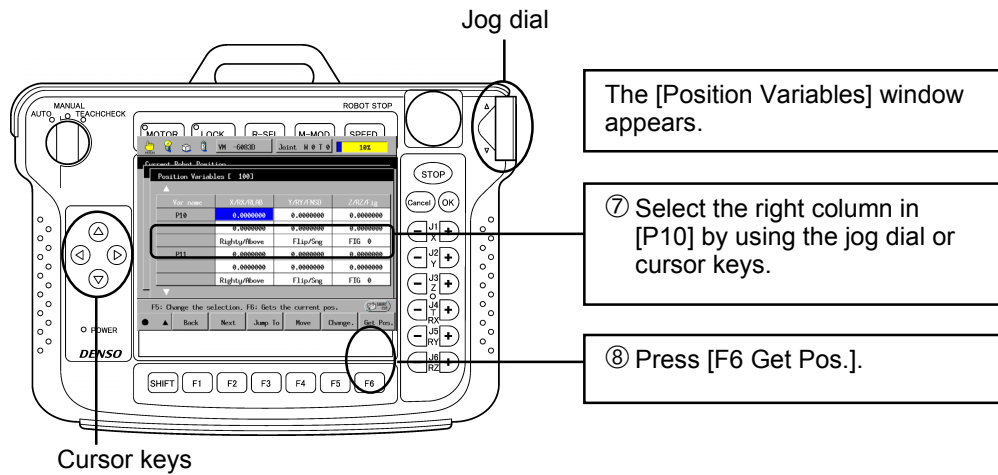

Step 5

Getting other position values into position variables

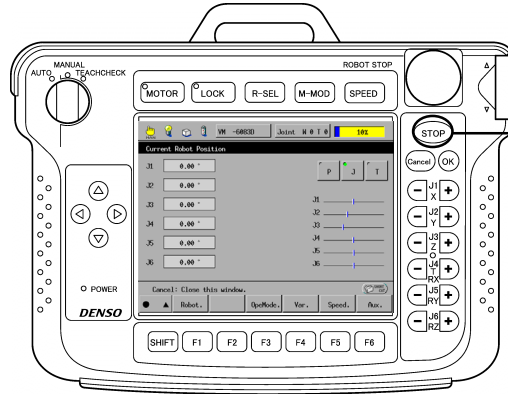

⑩ Press [Cancel] twice.
The screen returns to the [Current Robot Position]

⑪ Repeat Steps 2 to 4 to get the position data to [P11], [P12] and [P13] into other three variables [pPlace1], [pPlace2] and [P13], respectively.

Step 6

Returning to the top screen

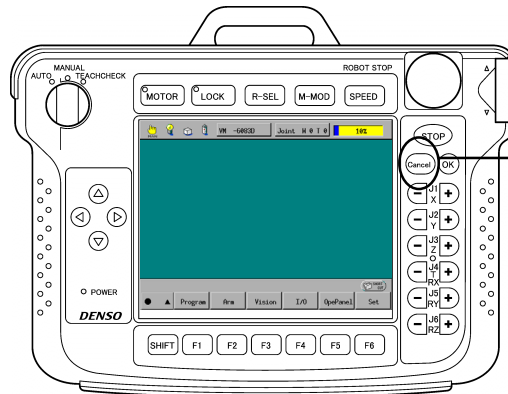

⑫ After finishing all of the above procedures, press [Cancel] to return to the top screen.

15.5 Starting programs

You will now actually run the robot using a program.

Caution: Always keep one hand free, ready to press the STOP key.

Step 1

Switching to Auto mode to display the program list window

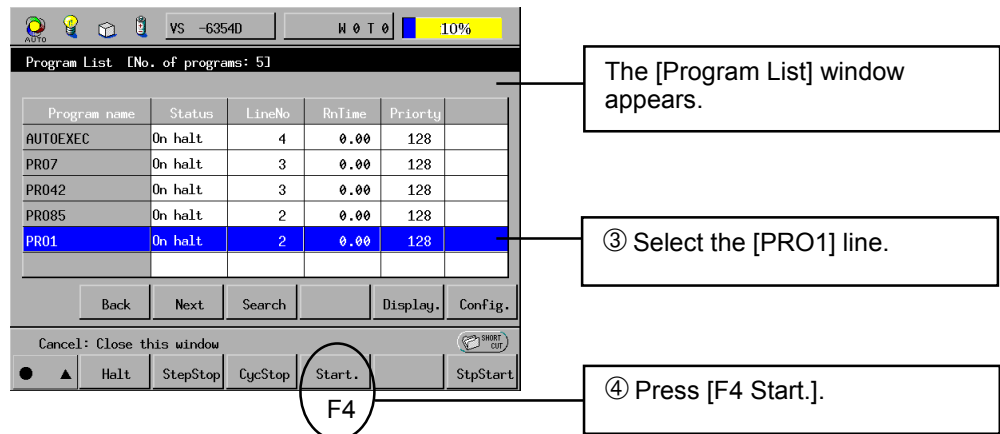
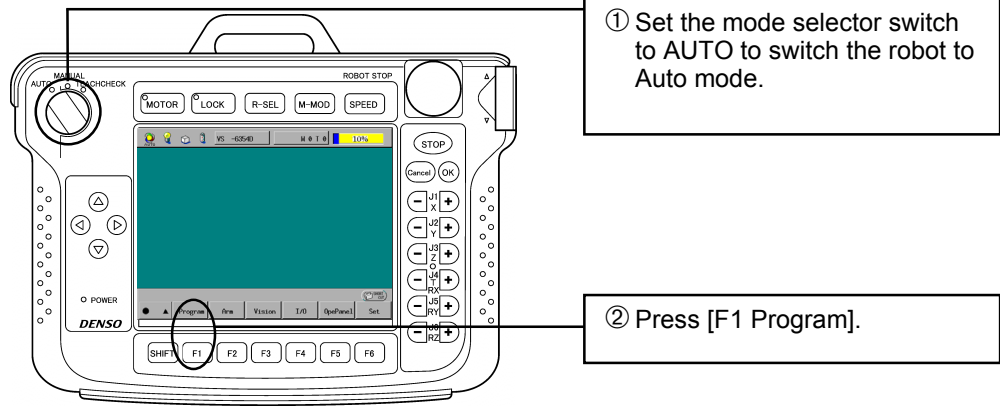

Step 2

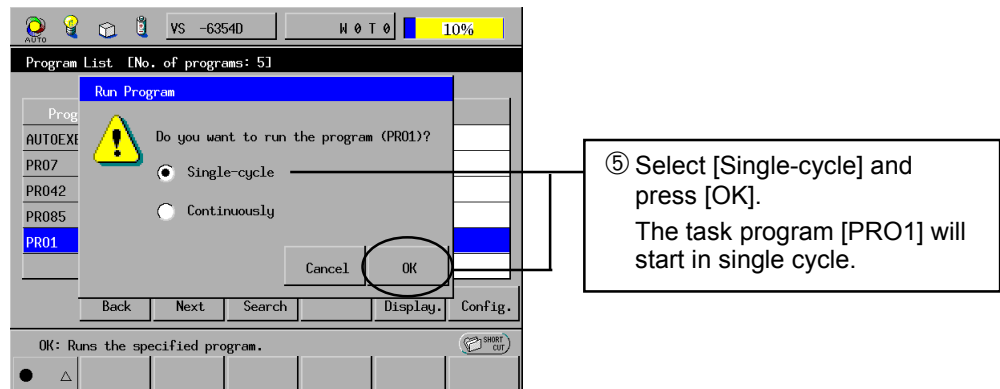

Step 3

If you select [Continuously] instead of [Single-cycle], the robot will start in the continuous mode.

If operation in single cycle mode is successful, try operation in the continuous start mode.

15.6 Changing the robot speed

Let the robot run faster by gradually changing the speed settings if you have been successful in both the single cycle run and continuous run.

Step 1

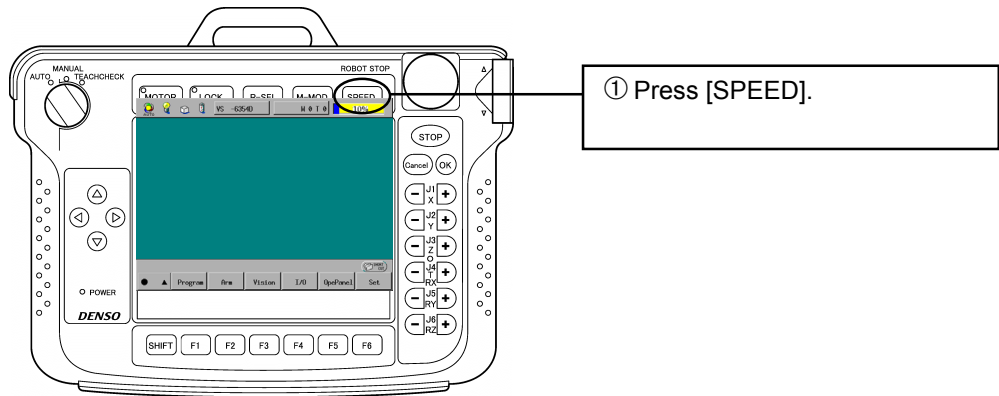

Step 2

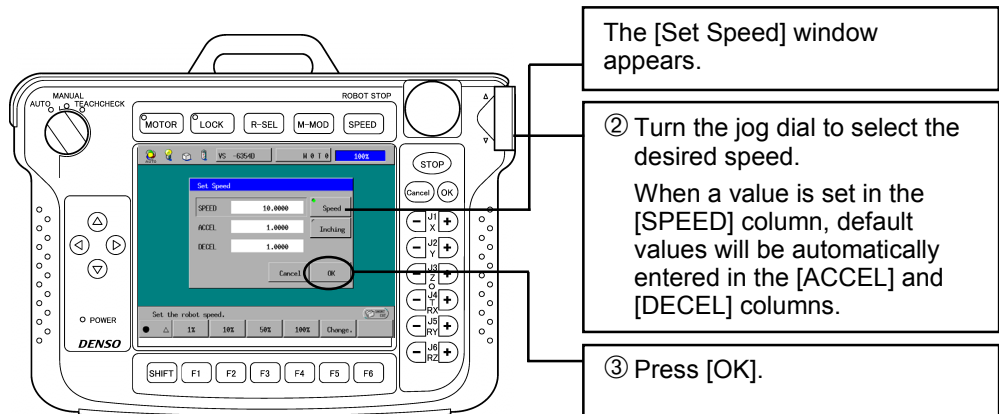

Robot speed, acceleration and deceleration are now set.

15.7 Stopping the robot in continuous running

If you stop the robot during continuous running by pressing the [STOP] button, the robot will change to [Continue Stop] status. In this state you can restart the program from the line where the program stopped.

If you want to abort the program completely, you need to perform [Program Reset].

Caution: In emergencies, press the Robot Stop button.

■ Making the program [Continue Stop] and [Continue Start]

Step 1

Making the task program [Continue Stop]

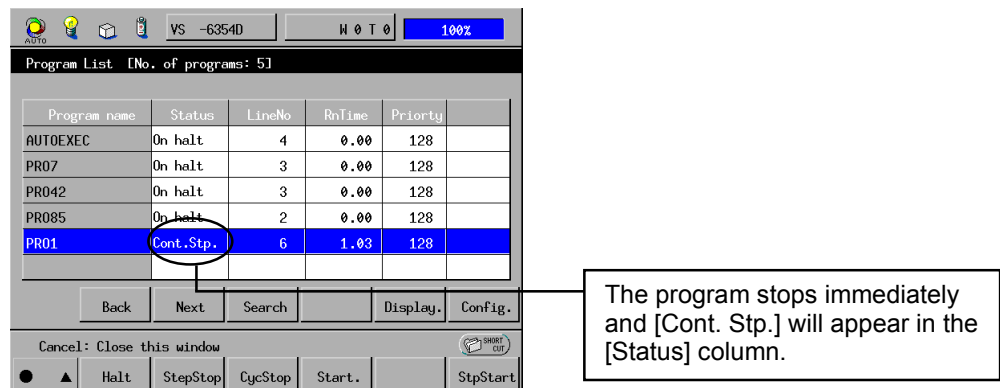
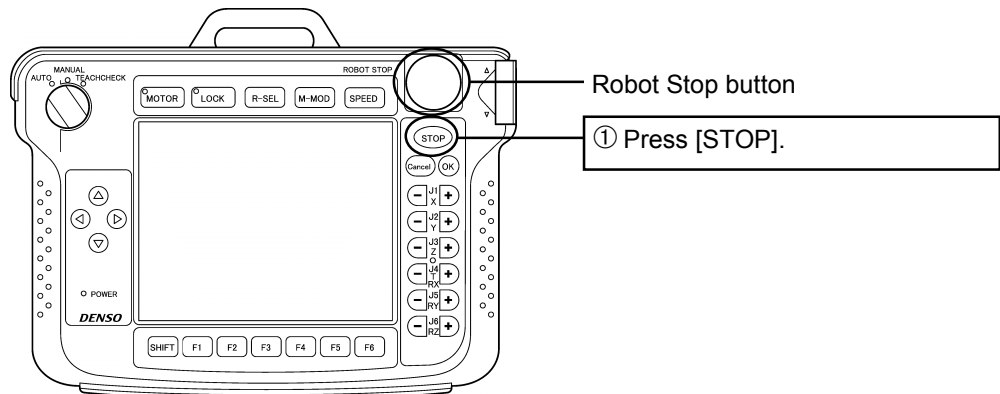

Step 2

Making the program [Continue Start]

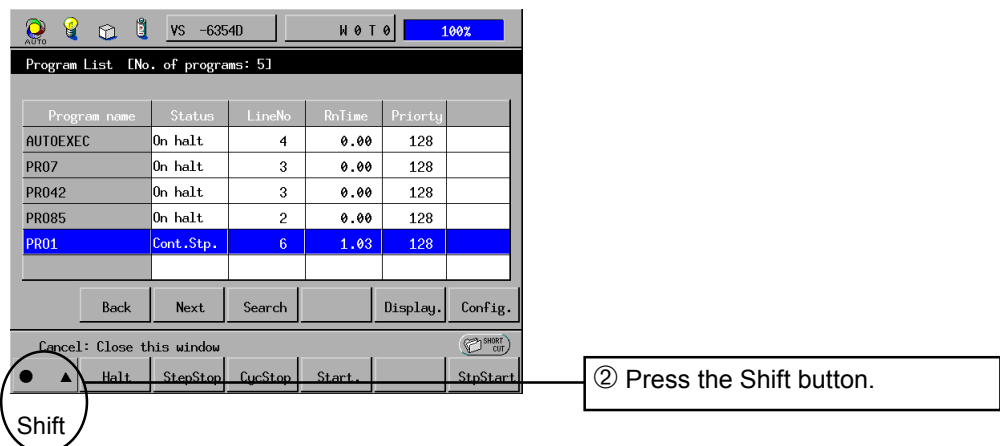

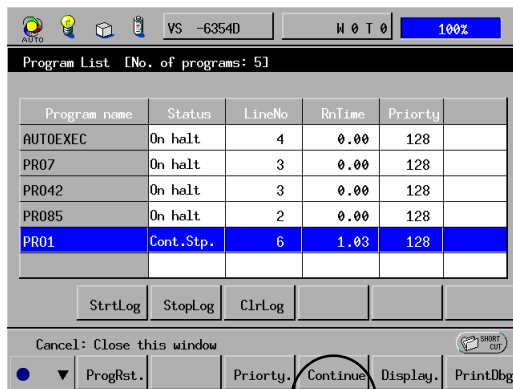

③ Press [F10 Continue].

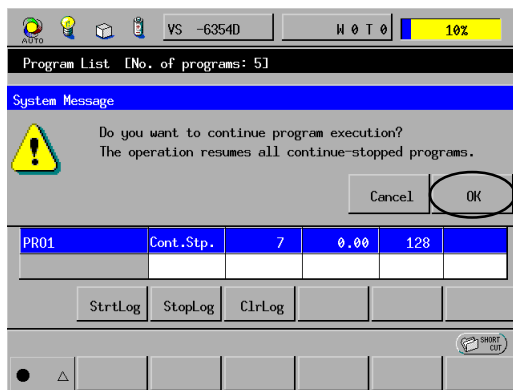

④ Press [OK].

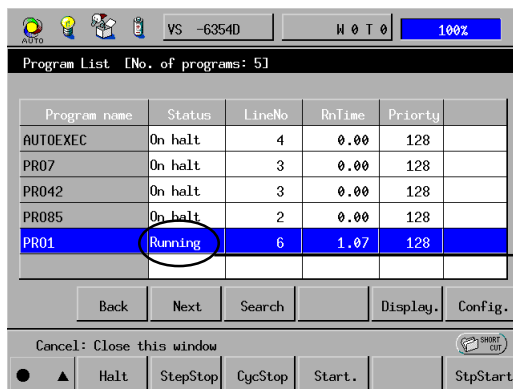

The program restarts and [Running] appears in the [Status] column.

Now you are ready to restart the program.

■ Stopping the program completely ([Program Reset])

Step 1

Making the program [Continue Stop]

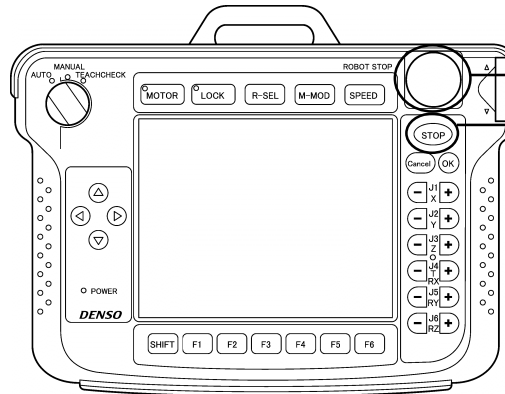

Robot Stop button

① Press [STOP].

The screenshot shows the 'Program List' window in the control software. The window title is 'Program List [No. of programs: 5]'. It contains a table with the following data:

Program name	Status	LineNo	RnTime	Priority
AUTOEXEC	On halt	4	0.00	128
PR07	On halt	3	0.00	128
PR042	On halt	3	0.00	128
PR085	On halt	2	0.00	128
PR01	Cont.Stp.	6	1.03	128

Below the table are buttons for 'Back', 'Next', 'Search', 'Display', and 'Config.'. At the bottom, there is a 'Cancel: Close this window' message and a 'SHORT STOP' button. A callout line points to the 'Cont.Stp.' status in the PR01 row.

The program stops immediately and [Cont. Stp.] appears in the [Status] column.

Step 2

Resetting the program ([Program Reset])

This screenshot is identical to the one in Step 1, showing the 'Program List' window with the PR01 row selected and its status as 'Cont.Stp.'. A callout line points to the 'Shift' button in the bottom control bar.

Shift

② Press the Shift button.



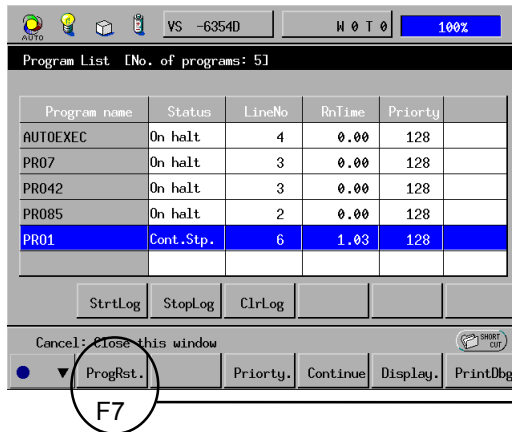

③ Press [F7 ProgRst.].

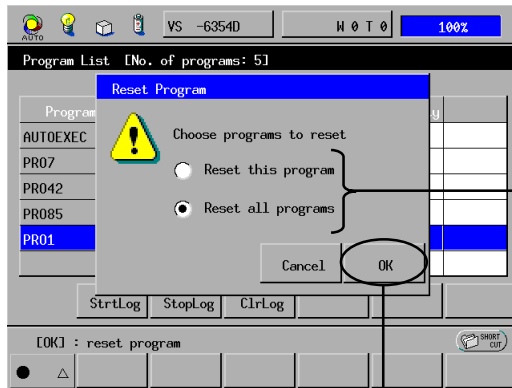

④ Select the program you want to abort.
 If you select [Reset this program], only the current program will be aborted.
 If you select [Reset all programs], all programs will be aborted.

⑤ Press [OK].

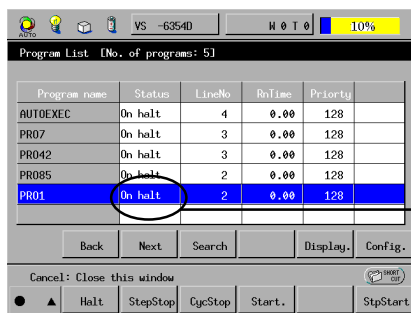

The program(s) is (are) aborted and [On halt] is displayed in the [Status] column.

The program(s) is (are) now aborted.

Lesson 16 Palletizing

16.1 What is palletizing?

Palletizing refers to placing parts in/removing parts from a partitioned pallet (shown below) in programmed order.

You can easily use library programs for palletizing. To use these programs you have to only know the number of partitions provided in the pallet and the positions of each of the 4 corners of the pallet, and teach this information to the robot.

The palletizing programs update the partition information as each position is called to enable the robot to know which partition it should place the next part in/remove the next part from.

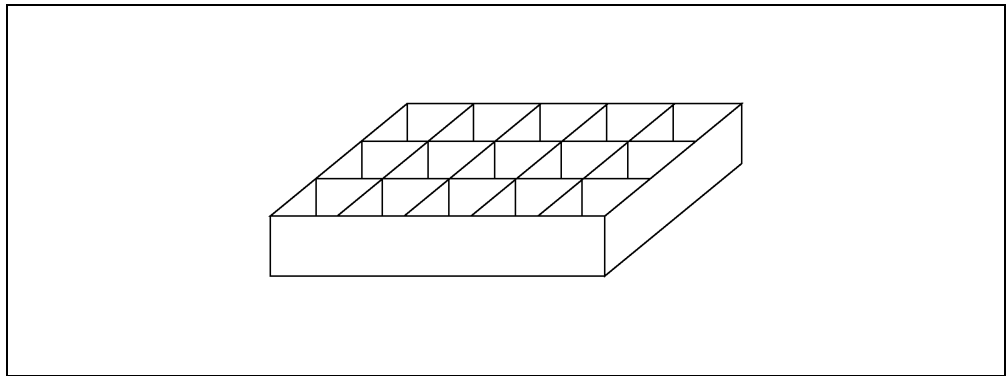

Figure 16-1 Partitioned pallet

Palletizing Program "PRO1"

Using the library, you can find a typical procedure to build a program in program "PRO1" under the title "Palletizing template 2," although there would actually be many different possible programs for palletizing depending on the applications and the circumstances in which they are being used.

Use this "palletizing template 2" effectively as your template by adding/deleting the items necessary for your applications.

Listed below is a sample template program named "PRO1."

This sample template assumes that

- the palletizing points should be at P50 to P55, and
- the program to be built would control the robot to move to the position P50 which is the work pick-up position, to run the palletizing program "0", to move to the position P51 which is the work piece mount position, to unchuck the work piece, to check end of the pallet, to replace the pallet if end of work signal detected and if needed, and to end the program if no work piece remains.

When you create "New Project" by selecting "Palletizing" in "Device Type," the system manager will automatically register the "Palletizing template 2" with program name "PRO1" and the "Palletizing initialization template 1" with program name "PRO2."

```
' !TITLE "Palletizing template 2"
' !AUTHOR "DENSO CORPORTION"
#DEFINE pltIndex 0
#DEFINE ChuckNG 40

PROGRAM PRO1                                ' Rename PRO1 as desired.
TAKEARM                                     ' Obtains the arm semaphore.
MOVE P, P50                                 ' Move to the position P50.
                                           ' Move to the palletizing position P50.
IF IO[ChuckNG] = ON THEN                    ' Check status of previous picking-up.
  CALL pltDecCnt(pltIndex)                  ' Subtract by 1 for the total counter.
END IF
CALL pltMove(pltIndex)                       ' Execute palletizing 0.
MOVE P, P51                                 ' Move to the mount position P51.
                                           ' Move to the palletizing position P51.
'<--- Insert unchucking or other operations here --->
CALL pltGetPLT1END(pltIndex,0)              ' Acquires the end of 1st pallet signal on I[0].
IF I[0] THEN                                ' If ON (that is when <>0),
  '<--- Insert pallet replacing or other operations here --->
  CALL pltResetPLT1END(pltIndex)           ' Clears the end of 1st pallet signal.
END IF
GIVEARM                                     ' Releases the arm semaphore.
END
```

Figure 16-2 Program [PRO1], "Palletizing template 2"

Palletizing parameters

Figure 16-3, 16-4, 16-5 and Table 16-1 show the parameters needed for palletizing.

PAC language retains these parameters as value sets of variables.

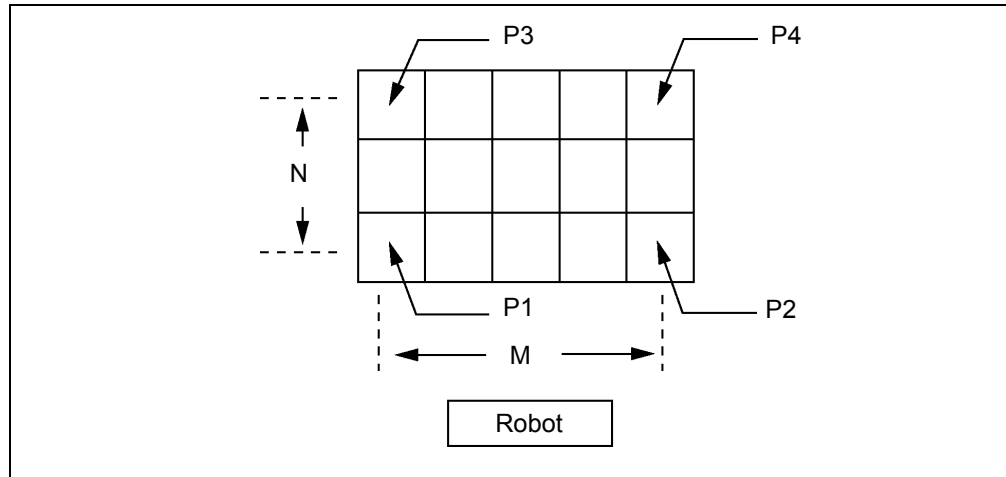

Figure 16-3 Upper view of pallet

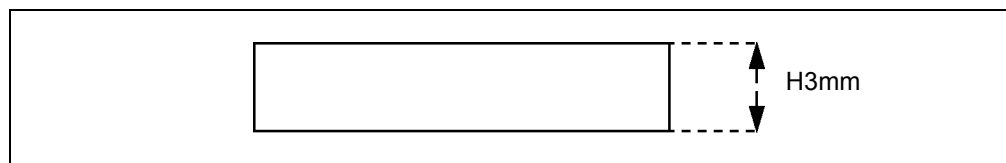

Figure 16-4 Side view of pallet

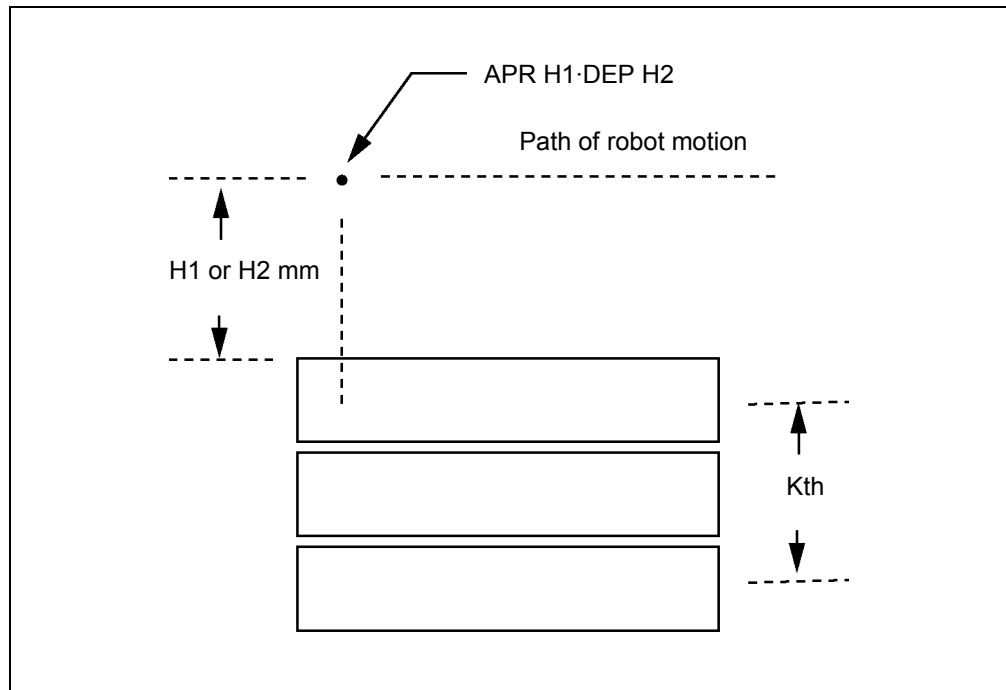

Figure 16-5 Stacked pallets

Table 16-1 Parameters needed for palletizing

Symbol	Name	Description	Unit
	Palletizing number	Index of palletizing	None (Integer)
N	No. of row parts	Number of partitions from P1 to P3	Count (Integer)
M	No. of column parts	Number of partitions from P1 to P2	Count (Integer)
K	No. of stacked pallets	Number of stacked pallets	Count (Integer)
H1	Approach clearance	Approach clearance where the robot approaches a pallet	mm (Single precision FPT)
H2	Depart clearance	Departure clearance where the robot departs from a pallet	mm (Single precision FPT)
H3	Height of a pallet	Height of a pallet	mm (Single precision FPT)
	Where H1 and H2 satisfy the conditions below. $H1 > \{H3 \times K - 1\} + 5$ $H2 > \{H3 \times K - 1\} + 5$		
P1 P2 P3 P4	Positions of the 4 corners of the pallet as shown in Figure 16-3. It is not possible to exchange the relative positioning of any of the corners. The robot maintains its orientation from where the position P1 was taught previously, for all points in the program.		

N Number of partitions in row
Expresses the number of partitions in each row of the pallet.
If this is 3, it reflects 3 rows as in the example in Figure 16-3.

M Number of partitions in column
This expresses the number of partitions in each column of the pallet.
If this is 5, it reflects 5 rows as in the example in Figure 16-4.

K Number of stacked pallets
This expresses the number of pallets in the pallet stack.
If this is 3, it reflects 3 stacked pallets as in the example on Figure 16-5.

H1 Approach clearance
Expresses the length of the approach path as the robot approaches the pallets.
A program applies the single approach path length at every call of the same palletizing program.

H2 Departure path clearance
Expresses the length of the departure path as the robot departs from the pallets.
A program applies the single departure path length at every call of the same palletizing program.

H3 Pallet unit heights
Expresses height of each pallet.
For every pallet added to a stack, a plus unit value is added.
For every pallet removed from a stack, a minus unit value is added.
If the stack is not changed, 0 is added.

Caution: H1 and H2 shall satisfy the conditions below.

$$H1 > \{H3 \times (K-1)\} + 5$$

$$H2 > \{H3 \times (K-1)\} + 5$$

If not, an error will occur during initializing. These restrictions ensure the robot does not crush the pallet in operation by ensuring the robot approaches or departs from the stacked pallets at 5 mm higher than the topmost pallet in a stack.

As shown in Figure 16-6, changing stack height does not affect the approach/departure points of the robot in same palletizing program.

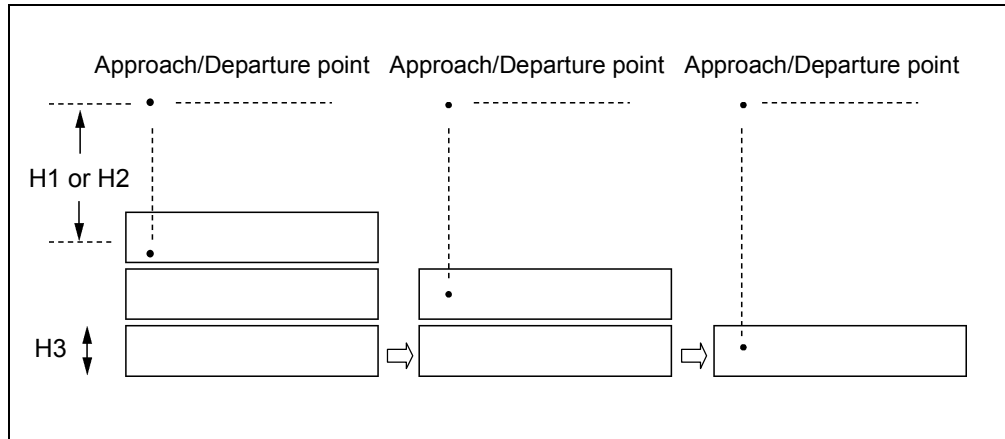

Figure 16-6 Relationship between the stack height and approach/departure points

Four corner points P1, P2, P3 and P4

These points represent the parts position for each of the 4 corner partitions of the pallet. Figure 16-7 depicts in what order the robot palletizes these parts.

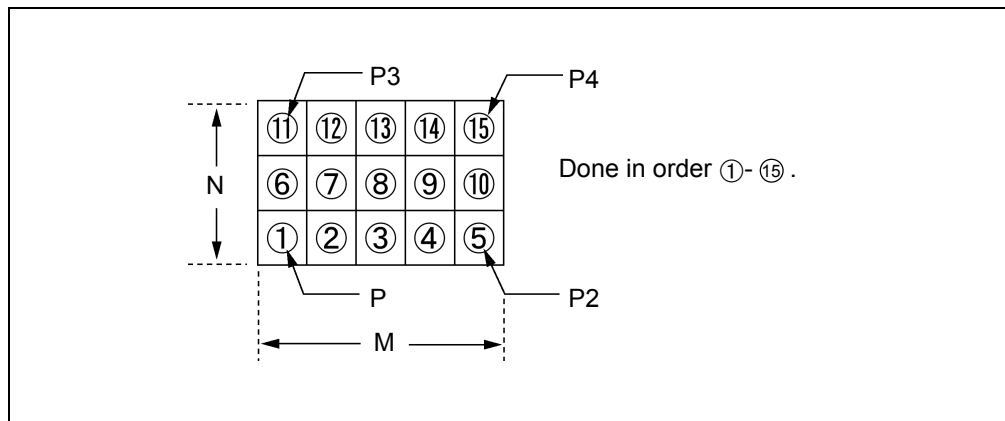

Figure 16-7 Palletizing order

Setting palletizing parameters

To set the parameter values such as the number of row and column partitions and the number of pallets in a stack, first call the "pltInitialize" module from the program library.

If you select [1-palletizing] in [Device type] in the [New project] dialog box when you want to create "New system project," the System Manager will automatically register the program "PRO2" titled "Palletizing initialization template 1" in the library. Since this program is to call "pltInitialize" module, modify the values of the indexes in the CALL statement to the ones you want to use.

```
!TITLE "Palletizing initialization template 1"
!AUTHOR "DENSO CORPORTION"

PROGRAM PRO2
  CALL pltInitialize(0,4,3,1,50,50,50,52,53,54,55)      'Initializing palletizing No. 0.
END
```

Figure 16-8 Library program "Palletizing initialization template 1"

```
Descriptions on parameters of CALL pltInitialize (0, 3, 5, 3, 50, 50, 10, 52, 53, 54, 55)
1st ... Palletizing program number (0)
2nd ... Number of row partitions (3)
3rd ... Number of column partitions (5)
4th ... Number of stacked pallets (3)
5th ... Approach clearance (50mm)
6th ... Departure clearance (50mm)
7th ... Pallet height (10mm)
8th ... P1 position (P52)
9th ... P2 position (P53)
10th ... P3 position (P54)
11th ... P4 position (P55)
```

} Designate only the indexes of the position variables.

Figure 16-9 Parameters of "pltInitialize"

You can also find descriptions on the above parameters in the "Command builder" tool provided in the PAC Manager of WINCAPSII.

Palletizing Counter

In palletizing, the robot counts the number of partitions as they change and retains the counts in the variables.

There are four types of counters; number of partitions in the row (N), number of partitions in the column (M), number of stacked pallets (K) and total (cnt).

These counters are defined in “pltKernl” which is the kernel program for controlling palletizing operation.

The library program “pltMove” adds 1 to the total counter every time a palletizing operation is completed and aligns the values of the other counters.

The library program “pltDecCnt” subtracts 1 from the total counter every time it is called and aligns each counter.

You can create up to 30 palletizing programs as the initial setting. Therefore, the system may provide 31 sets of the palletizing counters.

Count Rules

The palletizing counter adds 1 to the total counter every time “pltMove” is run and aligns the counts of the other counters so as to ensure the next pallet position.

If adding 1 to the total counter, the position of the pallet column indicated by the column counter (M) moves to the next column. If the pallet column position indicated by the column counter (M) reaches the end and becomes the maximum count, then the row counter (N) counts up by 1 to indicate the next row of the pallet and the column counter (M) becomes its minimum value. If the position of the row counter (N) reaches the end of the pallet row partition and becomes the maximum value, the stacked pallet counter (K) counts up by 1 and the row counter (N) becomes the set minimum value.

If you halt a palletizing program during operation and restart it, the robot moves to the next partition because the value of the counter variable is added to.

The system retains the contents of the palletizing counter even if the power is turned off. Unless you initialize the system after restarting, the robot will proceed to palletize from the previous counter value.

Caution: When you compile a new task program and load its run time module the system will automatically initialize the values of all variables.

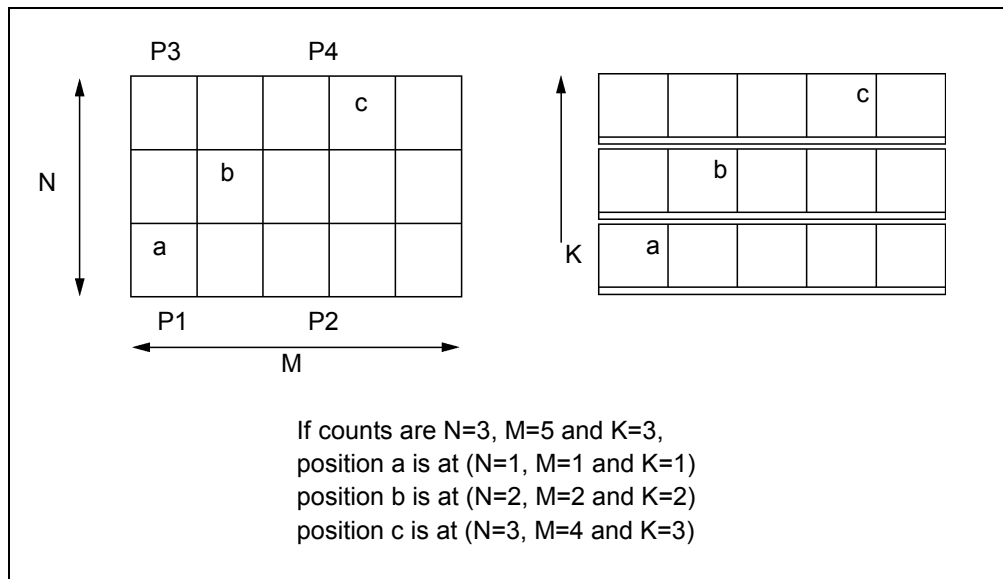

Figure 16-10 Relationship between palletizing position and counters

Initializing the Counters

When you replace any pallets or do not want to use any partitions, you need to initialize all of the counters.

The systems substitute 1 into all of the counters to initialize them.

If you use the library program "pltResetAll" you can initialize all the palletizing counters at once.

For example, if you want to initialize all counters for pallet number 1, write as follows.

```
CALL pltResetAll(1)
```

If you want to initialize each palletizing counter independently, use the library programs "pltLetN1," "pltLetM1," "pltLetK1" and "pltLetCnt."

For example, if want to initialize the N counter for pallet number 1, write as follows.

```
CALL pltLetN1(1,1)
```

Caution: The second argument is the value to substitute into the N counter. You can also choose any number instead of 1.

Ending palletizing program process

Upon finishing the palletizing for one of the stacked pallets or for the whole pallet stack, the palletizing program sets a stacked pallet end flag or whole pallet stack end flag, respectively.

To obtain the one stacked pallet finish flag status, use the library program "pltGetPLT1END." To obtain the whole pallet stack finish flag status, use the library program "pltGetPLTEND."

To reset the one stacked pallet finish flag to (0), use the library program "pltResetPLT1END." To reset the whole pallet stack finish flag to (0), use the library program "pltResetPLTEND."

16.2 Simplified Palletizing

Palletizing is explained in the “16.1 What is palletizing?”. For simpler palletizing, this section provides you with a simplified palletizing template using a palletizing library.

Simplified Palletizing Program "PRO1"

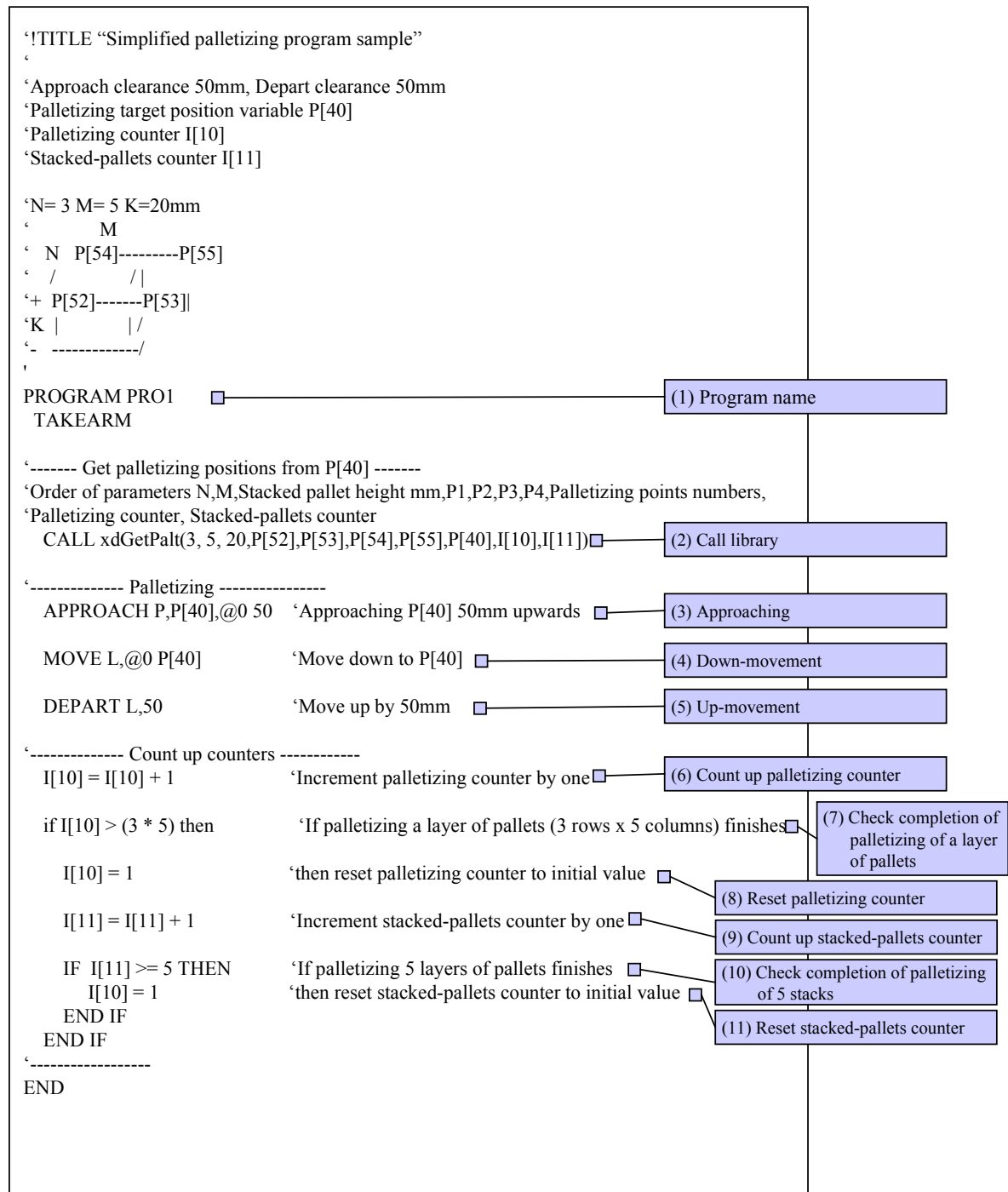

■ Simplified palletizing program "PRO1"

In palletizing explained in the "16.1 What is palletizing?", you need to execute the pltInitialize library before starting palletizing.

This simplified palletizing program requires no execution of that library. Just executing PRO1 will start palletizing operation.

In simplified palletizing, you need to specify addition and resetting of the palletizing counter and stacked-pallets counter, while in conventional palletizing those counters are automatically controlled inside libraries.

Variables used in PRO1

- Palletizing target position variable (Position variable, P40 in this example)
- Palletizing counter variable (Integer variable, I10 in this example)
- Stacked-pallets counter (Integer variable, I11 in this example)
- Corner partition variables (Position variables, P52 to P55 in this example)

What to do before execution of PRO1

Before start of PRO1, you need to:

- Assign the initial value "1" to each of the palletizing counter I10 and stacked-pallets counter I11 and
- Teach the positions of four corner partitions in the pallet to corner partition variables P1 to P4.

On the following pages are detailed explanation of each part of the program PO1.

(1) Program name

```
PROGRAM PRO1
TAKEARM
```

Change the program name

(2) Call library

```
----- Get palletizing positions from P[40] -----
Order of parameters N,M,Stacked pallet height mm,P1,P2,P3,P4,Palletizing points numbers
Palletizing counter, Stacked-pallets counter
CALL xdGetPalt (3, 5, 20,P[52],P[53],P[54],P[55],P[40],I[10],I[11])
```

Setting the following parameters to the called library will assign the target position to the palletizing target position variable specified by the 8th parameter.

- 1st parameter No. of rows, which should be 1 or greater.
(3 rows in this example)
- 2nd parameter No. of columns, which should be 1 or greater.
(5 columns in this example)
- 3rd parameter Height of stacked pallets in mm.
Specify a positive value when increasing the layers of pallets;
a negative value when decreasing them.
(20 mm specified in this example)
- 4th to 7th parameters Position variables to which four corner partition
positions of the pallet are assigned.
(P52 to P55 in this example)
- 8th parameter Palletizing target position variable to which the target position
will be assigned. This position may be calculated from the
current counter values.
(P40 in this example)
- 9th parameter Palletizing counter, which should be 1 or greater and M*N or
less. According to this value, the corner partition positions
may be specified.
- 10th parameter Stacked-pallets counter, which should be 1 or greater.
According to this value, the layer number may be specified.

(3) Approaching

(4) Down-movement

(5) Up-movement

‘----- Palletizing -----’
APPROACH P,P[40],@0 50 ‘Approaching P[40] 50mm upwards
MOVE L,@0 P[40] ‘Move down to P[40]
DEPART L,50 ‘Move up by 50mm

As a result of execution of "(2) Call library," the palletizing target position is assigned to P40. Then some operations should be carried out to P40.

Usually, during those operation, chuck and unchuck processes will be inserted.

- (6) Count up palletizing counter
- (7) Check completion of palletizing of a layer of pallets
- (8) Reset palletizing counter
- (9) Count up stacked-pallets counter
- (10) Check completion of palletizing of 5 layers of pallets
- (11) Reset stacked-pallets counter

```

'----- Count up counters-----
I[10] = I[10] + 1      'Increment palletizing counter by one

if I[10] > (3 * 5) then  'If palletizing a layer of pallets (3 rows x 5 columns) finishes
  I[10] = 1             'then reset palletizing counter to initial value
  I[11] = I[11] + 1    'Increment stacked-pallets counter by one
  IF I[11] >= 5 THEN   'If palletizing 5 layers of pallets finishes
    I[10] = 1         'then reset stacked-pallets counter to initial value
  END IF
END IF

```

This part of the PRO1 counts up the palletizing counter and stacked-pallets counter and checks the completion of palletizing operation for a layer of pallets.

Unlike usual palletizing programs, the simplified palletizing program uses integer variables (I10 and I11 in this example) as a palletizing counter and stacked-pallets counter.

According to the values assigned to I10 and I11, the "(2) Call library" calculates the palletizing target position and assigns it to P40.

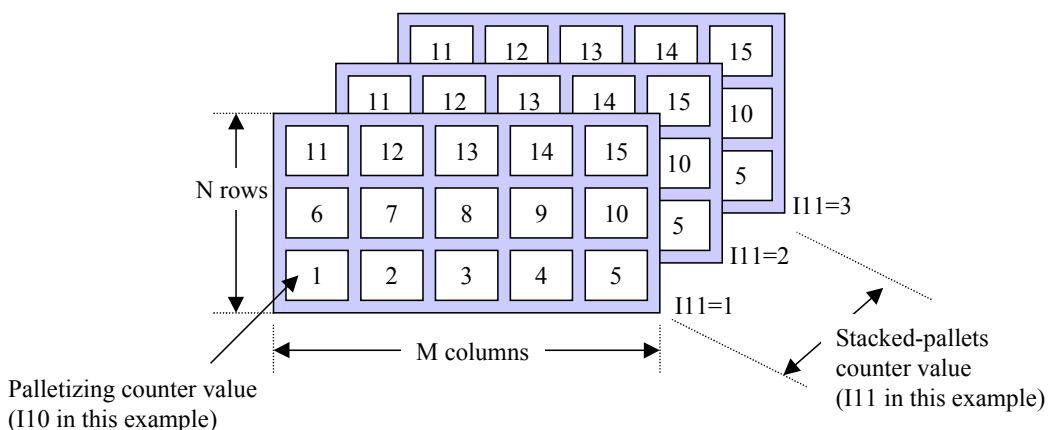

For a single layer of pallet, you may simplify the program further as shown below.

```

----- Count up counters-----
I[10] = I[10] + 1      'Increment palletizing counter by one

if I[10] > (3 * 5) then  'If palletizing a layer of pallets (3 rows x 5 columns) finishes
  I[10] = 1              'then reset palletizing counter to initial value
  I[11] = I[11] + 1     'Increment stacked-pallets counter by one
  IF I[11] >= 5 THEN    'If palletizing 5 layers of pallets finishes
    I[10] = 1          'then reset stacked-pallets counter to initial value
  END IF
END IF

```

Delete these lines for a single layer of pallet.

■ Relationship between the palletizing positions and counter values in the simplified palletizing program

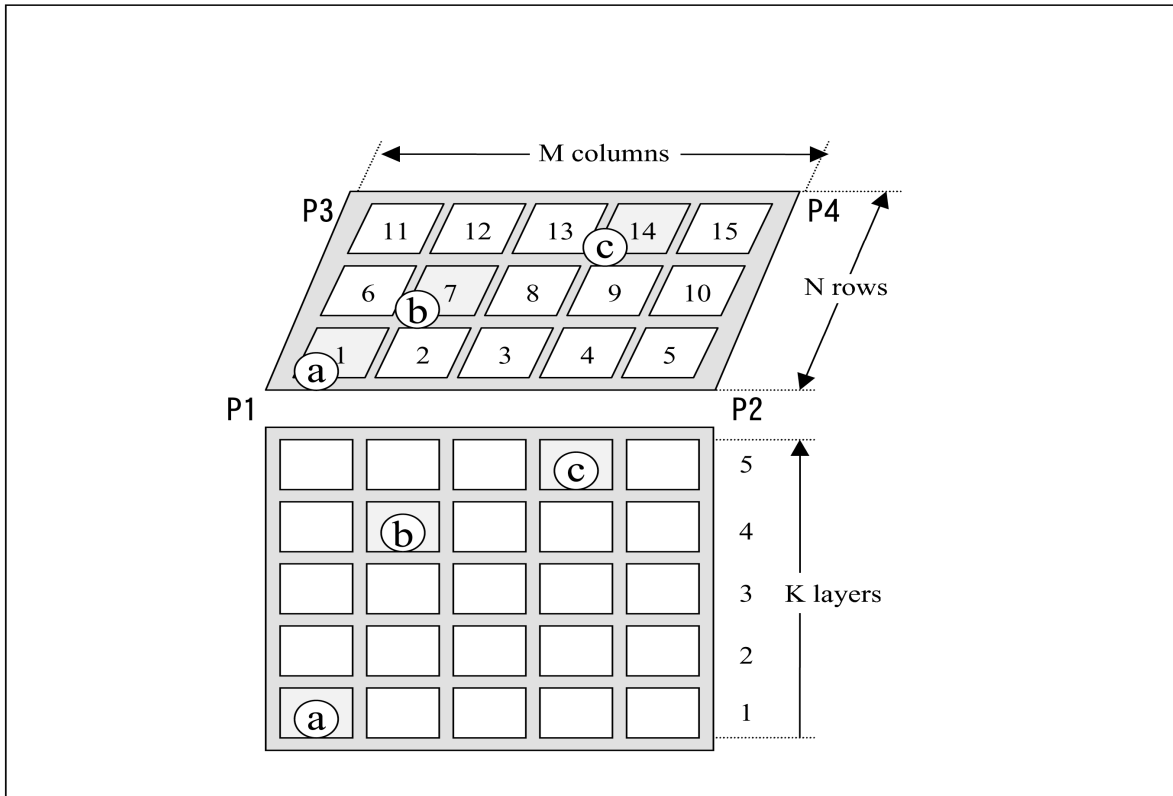

■ Applications of the simplified palletizing program
 --- Special-purpose palletizing examples ---

(1) Alternate checker-pattern palletizing

Alternate checker-pattern palletizing refers to palletizing to every other partitions as illustrated below. Programming for this is very easy.

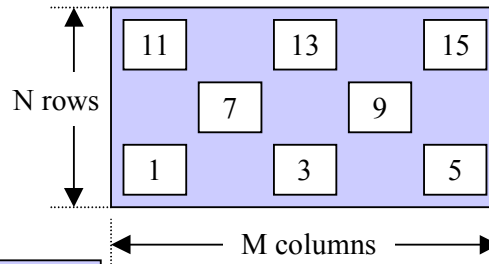

(6) Count up palletizing counter

```

  '----- Count up counters -----
  I[10] = I[10] + 1      'Increment palletizing counter by one
  
```

```

  '----- Count up counters -----
  I[10] = I[10] + 2      'Increment palletizing counter by 2
  
```

You need to assign "1" to palletizing counter I[10] with the teach pendant beforehand.

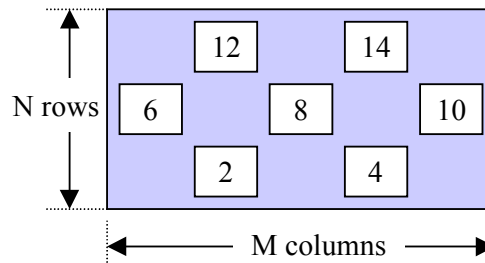

(6) Count up palletizing counter

```

  '----- Count up counters -----
  I[10] = I[10] + 1      'Increment palletizing counter by one
  if I[10] > (3 * 5) then 'If palletizing a layer of pallets (3 rows x 5 columns) finishes
  I[10] = 1              'then reset palletizing counter to initial value
  
```

↓

```

  '-----Count up counters -----
  I[10] = I[10] + 2      'Increment palletizing counter by 2
  if I[10] > (3 * 5) then 'If palletizing a layer of pallets (3 rows x 5 columns) finishes
  I[10] = 2              'then reset palletizing counter to second value
  
```

You need to assign "2" to palletizing counter I[10] with the teach pendant beforehand.

(2) Skipped palletizing

Skipped palletizing skips arbitrary partitions in palletizing.

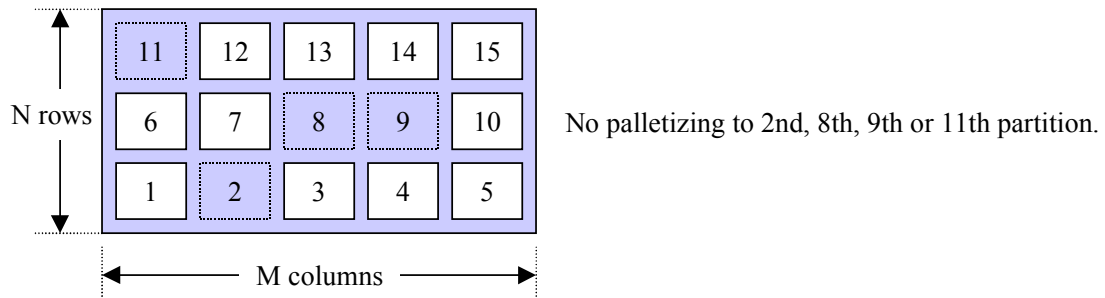

The above palletizing operation seems complicated, but you may easily program such palletizing just by changing the palletizing counter value that will pass to the library.

```
PROGRAM PRO1
TAKEARM
```

```
'----- Get palletizing positions from P[40] -----
```

```
'Order of parameters N,M,Stacked pallet height mm,P1,P2,P3,P4,Palletizing points numbers
```

```
'Palletizing counter, Stacked-pallets counter
```

```
CALL xdGetPalt(3, 5, 20,P[52],P[53],P[54],P[55],P[40],I[10],I[11])
```

```
PROGRAM PRO1
TAKEARM
```

```
SELECT CASE I[10]
```

```
CASE 2 'If palletizing counter I[10]=2
I[10] = 3 'then set the counter to 3
```

```
CASE 8,9 'If palletizing counter I[10]=8 or 9
I[10] = 10 'then set the counter to 10
```

```
CASE 11 'If palletizing counter I[10]=11
I[10] = 12 'then set the counter to
```

```
END SELECT
```

```
'----- Get palletizing positions from P[40] -----
```

```
'Order of parameters N,M,Stacked pallet height mm,P1,P2,P3,P4,Palletizing points numbers
```

```
'Palletizing counter, Stacked-pallets counter
```

```
CALL xdGetPalt(3, 5, 20,P[52],P[53],P[54],P[55],P[40],I[10],I[11])
```

Lesson 17 Using Libraries Effectively

You can assemble existing programs into a project in any of the following three ways.

- Program bank:

You can add any programs registered in the program bank to your new project.

- Importing programs:

You can register any programs into your new project folder by copying programs already created for another program project.

- Adding programs:

You can register any programs already created for other program projects into your new project. In this case, the projects it is registered with share the program.

You can effectively apply existing programs to your new project using any of the methods above. Some examples to do so follow.

17.1 Program bank

Let's add the program "dioSetAndWait" from the program bank to your new project.

Step 1

Searching the program bank

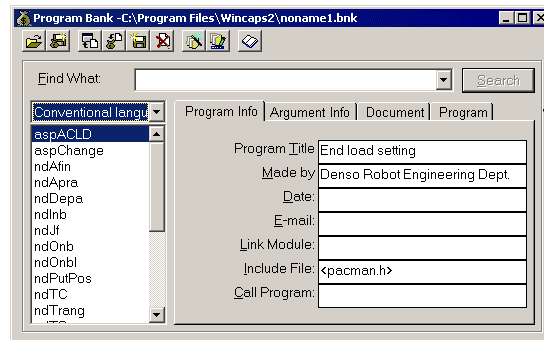

① Select [Program Bank] from the Tool menu in the [PAC Manager window].

The [Program Bank] window appears.

Step 2

Choosing the class

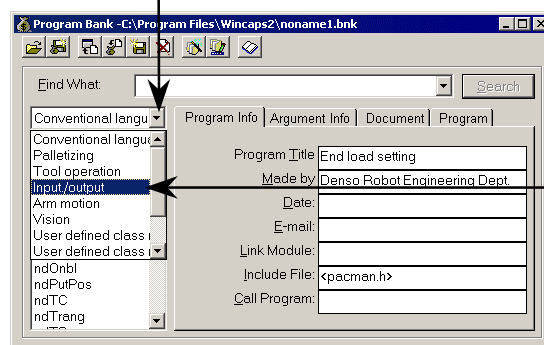

② Click the class selection box. The class selection pull-down menu appears.

③ Select [Input/output].

Step 3

Choosing a program to be added

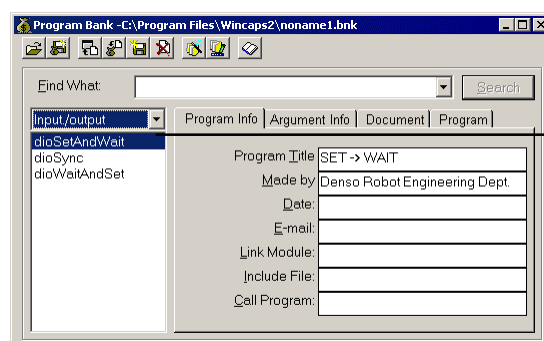

The program name list box shows the titles of programs registered in the [Input/output Class].

④ Select [dioSetAndWait] displayed in the list.

Step 4

Adding the program to a new project

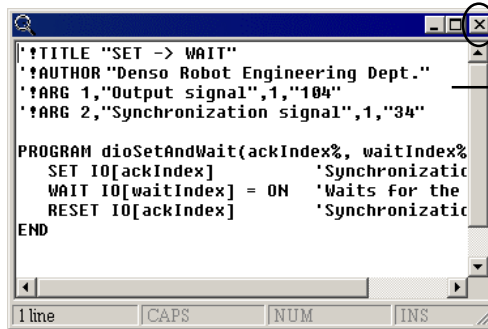

```
!TITLE "SET -> WAIT"
!AUTHOR "Denso Robot Engineering Dept."
!ARG 1,"Output signal",1,"104"
!ARG 2,"Synchronization signal",1,"34"

PROGRAM dioSetAndWait(ackIndex%, waitIndex%
  SET IO[ackIndex] 'Synchronizati
  WAIT IO[waitIndex] = ON 'Waits for the
  RESET IO[ackIndex] 'Synchronizati
END
```

1 line CAPS NUM INS

⑤ Click [Add to Project].

[dioSetAndWait] is registered in the new project and the [Edit] window appears.

⑥ Click here to close the [Program Bank] window. The window will close.

17.2 Importing programs

Let's import two programs, "pro1" and "pro2" into your new project. If you have installed WINCAPSII in "Typical," these programs will be in the directory C:\ProgramFiles\Wincaps2\Sample\modelcase\.

Step 1

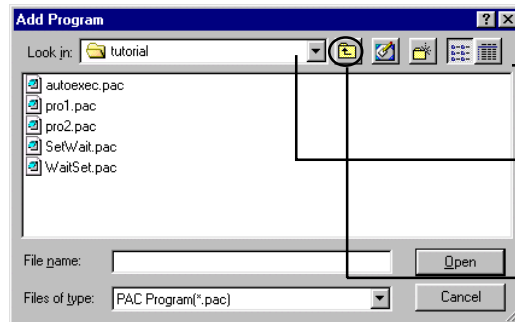

① Select [Import] from the Program menu, in the [PAC Manager] window.

The [Add Program] dialog window is displayed.

The [Tutorial] folder of the current system folder is displayed in the window.

② Click the [Previous] button



Step 2

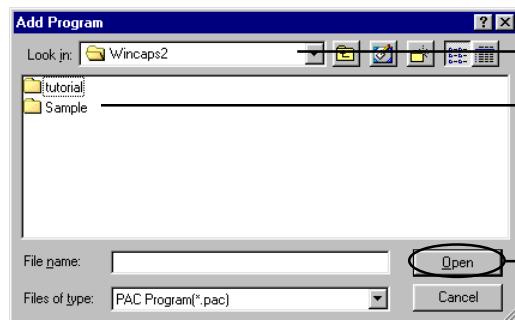

The [Wincaps2] folder is displayed in the [Look in] window, showing the directory holding programs you are seeking.

③ Select the [Sample] folder and click [Open].

Step 3

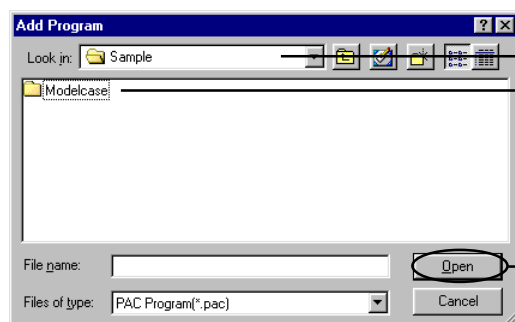

The [Look in] window display changes to the [Sample] folder.

④ Select the [Modelcase] folder and click [Open].

Step 4

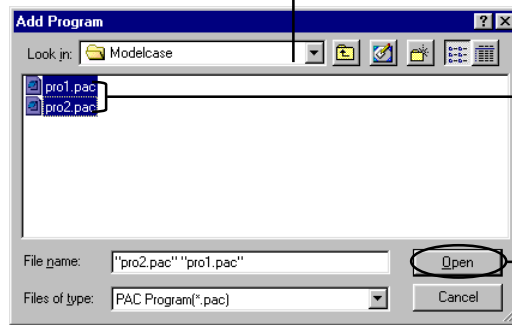

Step 5

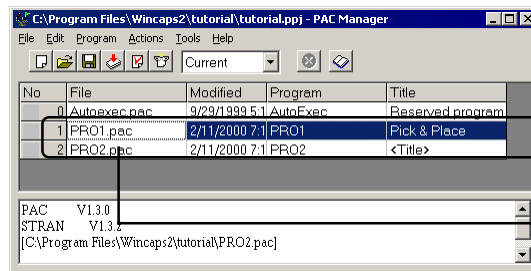

★Tip ★

You can also open the program edit window by selecting [Show] in [Action] menu after clicking [PRO1.pac] to select it.

Step 6

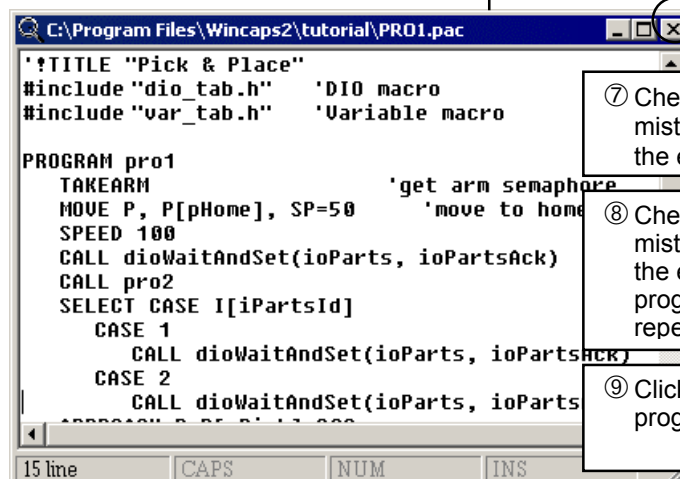

Lesson 18 Terminating the Session

Let's close this session of Part 4 in both the PC and robot controller.

18.1 Terminating WINCAPSII and shutting down the PC

Step 1

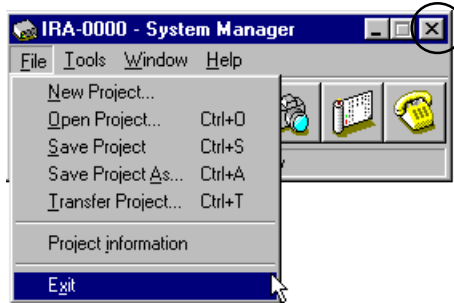

① Click the closing box in the upper right corner of the [System Manager] window. All WINCAPSII software on the PC will be exited.

Step 2

If needed, close the OS, such as Windows95, and shut down the PC.

18.2 Turning the robot controller OFF

Step 1

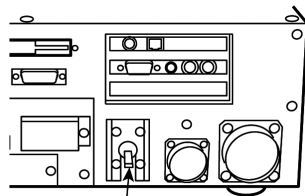

① Flip the power switch downward to turn the robot controller OFF.

Part 5

Features of DENSO Robots

In Part 5, you will:

Learn the useful and advantageous features of DENSO robots such as compliance control. These features are effective for reducing installation costs and improving the efficiency of the preparation work and practical work.

▶ Lesson 19 Compliance Control	126
19.1 Current limit function for individual axes	126
19.2 Tip compliance function	127
▶ Lesson 20 Other Features	128

Lesson 19 Compliance Control

Compliance control provides compliance for robots by software. This feature may absorb misalignment errors encountered when parts are mated during assembly operations or loaded into fixture and prevent robots or workpieces from undergoing excessive force.

Two types of compliance control are available: one is a current limit function that sets compliance to individual joints, and the other is a tip compliance function that sets compliance to individual elements of the coordinates formed at the end of the robot flange (the mechanical interface coordinates).

NOTE: The current limit function is available for Ver 1.2 or later. The tip compliance function is available for the V*-D series (excluding the VM-6070D), Ver. 1.4 or later.

19.1 Current limit function for individual axes

This function provides compliance for individual axes by limiting the drive torque (current) of each axis motor. It prevents excessive force from applying to robots or workpieces or avoids robot stops caused by an overload or overcurrent error.

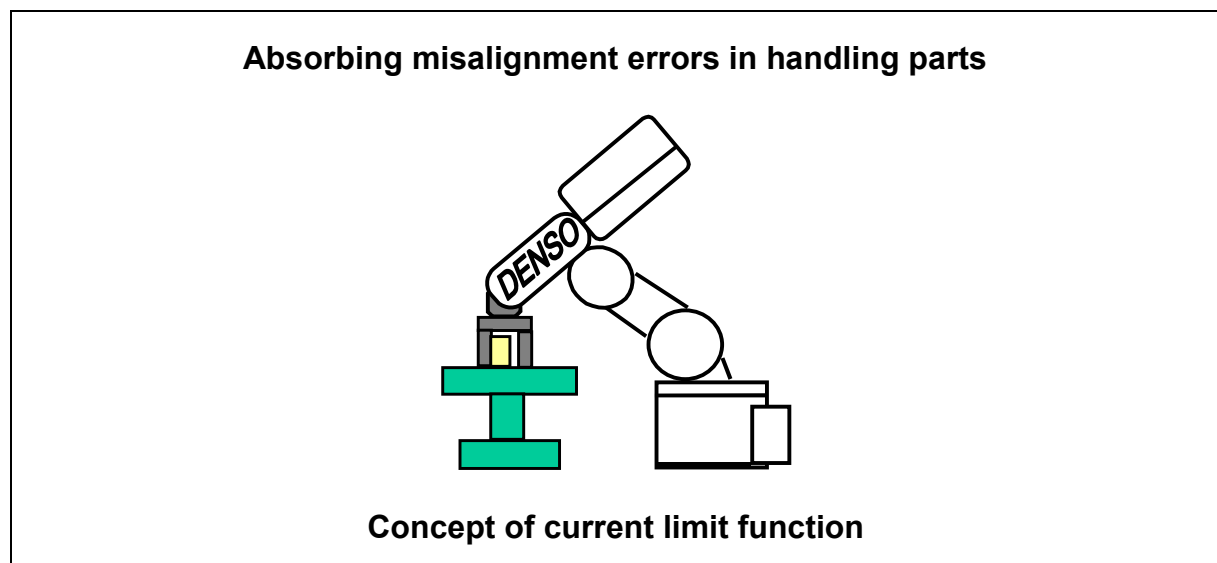

■ Enabling/disabling the current limit function

You may enable or disable the current limit function by executing the current limit library, SetCurLmt or ResetCurLmt, respectively. For details, refer to the PROGRAMMER'S MANUAL.

19.2 Tip compliance function

This function sets compliance to the individual elements of coordinates at the end of the robot flange (tip) by controlling the drive torque (current) of each axis motor based on the force limit at the tip. You may select the base coordinates, tool coordinates, or work coordinates to be applied. This function is used to make the robot follow an external force in a specified direction(s) or to make the robot touch an object for height check.

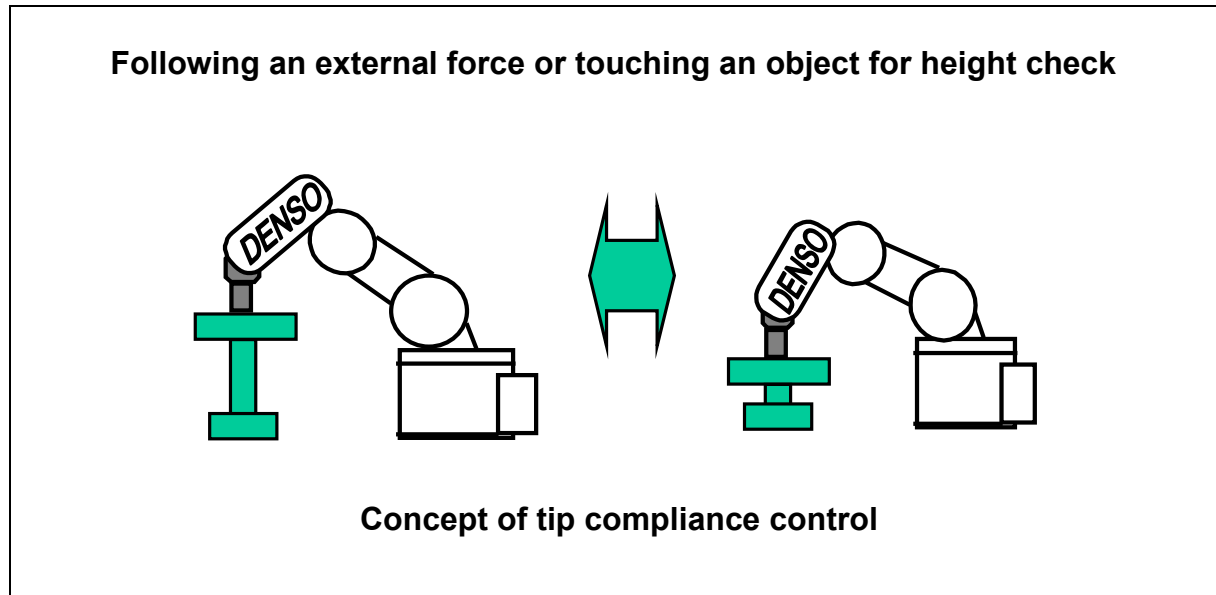

■ Making the tip compliance function active from the teach pendant

This is one of the extended functions. You need to make extended functions active from the teach pendant. Once made active, the setting will be retained after the controller power is turned off.

■ Enabling/disabling the tip compliance function

You may enable or disable the tip compliance function by executing the compliance control library, `SetCompControl` or `ResetCompControl`, respectively. For details, refer to the PROGRAMMER'S MANUAL.

Lesson 20 Other Features

In addition to compliance control, DENSO robots have the following features. Refer to the PROGRAMMER'S MANUAL for more details.

Name	Outline of the features and commands	Related commands
Interference area check	An output signal is issued from the specified I/O port when the robot arm end is within the designated area. These commands are useful to confirm the original position and the working position.	AREA SETAREA RESETAREA
Interrupt stop feature	When any interrupt signal of the system I/O port is ON, the current operation command is terminated and the next operation command is processed. This command is useful when you want to change the robot stop position through external input. However, the distance until the robot stops depends upon the speed setting of the operation command and the actual speed of the robot.	INTERRUPT ON/OFF
Parallel execution function of operation/non-operation command	The non-operation command can be executed during the execution of an operation command. This command is useful to shorten the cycle time.	IOBLOCK ON/OFF
Multi-task feature	More than one program can be run concurrently. It is possible to shorten cycle time by checking the external interlock and executing vision commands in other programs.	RUN KILL etc.
Program debugging facilities	It is possible to display messages and sound a beeper. This is useful for debugging user programs.	PRINTMSG PRINTDBG BUZZER
Optimal payload setting feature	This makes it possible to set acceleration speed appropriate to the mass of the workpiece and end-effector. This makes it possible to shorten cycle time.	aspACLD aspChange

Appendices

▶ Appendix-1 Glossary	130
▶ Appendix-2 Names of the robot controller parts	140
▶ Appendix-3 Names of the teach pendant parts	142
▶ Appendix-4 Menu tree of the teach pendant	144

Appendix-1 Glossary

A

ABOVE

One of the elbow figures of 6-axis robot. (⇔ BELOW)

ABSOLUTE MOTION

The motion to move to the motion target position set by teaching. (⇔ relative motion)

ADDRESS SETTING (IP address)

To set the controller IP address. It is required in Ethernet communication.

APPROACH VECTOR

Positive directional vector of Z-axis on the mechanical interface coordinates.

AREA

The number of white and black pixels in a window when an image data is binarized. (Vision terms)

ARM CONFIGURATION MACRO DEFINITION FILE

The file which contains the macro definition information of the arm setting data.

ARM FIGURE

The figure determined by the value of the 1st through the 3rd axes of 6-axis robot. There are two kinds of figures; RIGHTY and LEFTY.

ARM FILE

The file in which the information peculiar to the robot is recorded. The arm manager uses the file.

ARM MANAGER

The software which simulates the robot movement.

ARM SEMAFORE

The privilege of robot control. The task which has the privilege can operate the robot.

AUTOMATIC ROBOT RUN

To run the robot by executing a program.

B

BASE

The portion to install the 1st axis of the robot.

BASE COORDINATES

The three dimensional orthogonal coordinate system which has the origin on the robot base.

BASE MOUNTING SURFACE

The junction surface of the base and the installation frame.

BELOW

One of the elbow figures of 6-axis robot. (⇔ ABOVE)

BINARIZATION

To change the brightness of each pixel to either white (0) or black (1) by the threshold value (binarization level).

BINARIZATION LEVEL

The threshold value of binarization. (Vision terms)

BRAKE-OFF (releasing brakes)

To release the brake of each axis.

BRAKE-ON (locking brakes)

To apply the brake of each axis.

BRIGHTNESS

The numerical value (0-255) which shows the brightness of each pixel. (Vision terms)

BRIGHTNESS INTEGRAL VALUE

The value which is the sum of the brightness of all the pixels in the window. (Vision terms)

C

CAL

Slight movement of all axes of the robot to make the robot confirm the current position after the robot controller power on.

CALSET

Calibration of the relation between the actual robot position and the positional information of the controller.

CALSET OF A SINGLE AXIS

To perform CALSET on the specified axis only.

CENTER OF GRAVITY

The balance point on which the object weight balances on a plane. (Vision terms)

COMMAND AREA

A group of I/O ports which specify the I/O command type.

COMMAND EXECUTION I/O SIGNAL

The input/output signal fixed to the system in order to inform the execution of I/O command and the execution status to the outside.

COMMAND PROCESSING COMPLETE

The output signal to inform the completion of I/O command processing to the outside.

COMMAND

The instruction written in a program. The controller reads commands in the sequence written in a program, interprets commands and executes.

COMMENT

Explanatory notes in a program to make the program easy to understand. The controller does not execute comment.

COMMUNICATION LOG

The record of the communication condition between the PC and the robot.

COMPATIBLE MODE

The mode in which the I/O allocation is set to be compatible with the conventional series of robots. It is switched by software.

CONTINUOUS START

The start method to execute a program in iteration. The operation continues until it is forced to stop.

CONTROL LOG

The record of the specified value, the encoder value, the current value and the load ratio. They are recorded by each motion axis.

CONVENTIONAL LANGUAGE

The robot language used in Denso robot conventionally.

CP CONTROL

Compensation control to make the path from the current position to the motion target position a straight line or a circle. (↔ PTP control)

CURRENT POSITION

The current position of the origin of the tool coordinates.

CYCLE STOP

The stop method to stop a program after one cycle execution.

D VARIABLE (Double-precision variable)

The variable which has a value of double precision real number (15 digits of effective precision).

D**DAILY INSPECTION**

The inspection before the daily work.

DATA AREA

A group of I/O ports to specify the necessary data for I/O command.

DEADMAN SWITCH

The switch which moves robot as long as any of the arm traverse keys is pressed simultaneously for safety. The robot stops immediately when either the arm traverse key or the deadman switch is released.

DEFINING INTERFERENCE AREA

To define the interference area. It is set either with the teach pendant, in WINCAPSII or with the program command.

DEFINING TOOL COORDINATES

To define tool coordinates. Origin offset amount and rotational angle amount around each axis are defined in reference to the mechanical interface coordinates. TOOL1 through TOOL63 can be defined.

DIO MANAGER

The software which monitors I/O condition and manages I/O allocation.

DISCRIMINATION ANALYSIS METHOD

The method to set the binarization level from the histogram using statistical method. (Vision terms).

DOUBLE

One of the 6th axis figures of 6-axis robot. (⇔ SINGLE)

DOUBLE4

One of the 4th axis figures of 6-axis robot. (⇔ SINGLE4)

E

EDGE

Transition point of brightness. (Vision terms)

ELBOW FIGURE

The figure determined by the 2nd and the 3rd axis value of 6-axis robot. There are two kinds of elbow figures; ABOVE and BELOW.

ENABLE AUTO

The signal to enable auto mode in ON condition. Manual mode and teach check mode are possible in OFF condition.

ENCODER VALUE CHECK MOTION

The motion which judges that the target position is reached when the encoder value becomes within the specified pulse range toward the motion target position set by teaching.

END MOTION

The motion which judges that the target position is reached when the specified position of the servo coincides with the motion target position set by teaching.

ERROR CODE

Four digits hexadecimal code which describes error causes/conditions occurred in the robot or in WINCAPII. Refer to the error code table for the meaning of each error code.

ERROR LOG

Record of the error content and occurred time.

ETHERNET BOARD

One of the controller optional boards. It is used to communicate with WINCAPSII through TCP/IP protocol.

EXECUTION PROGRAM

The program converted to the data format intelligible to the robot.

EXTERNAL ACCELERATION

The acceleration value set with the teach pendant. Percentage value to the maximum acceleration is inputted.

EXTERNAL AUTOMATIC RUN

To execute a program from the external device.

EXTERNAL DECELERATION

The deceleration value set with the teach pendant. Percentage value to the maximum acceleration is inputted.

EXTERNAL MODE

The mode in which robot operation is possible from the external device.

EXTERNAL SPEED

The speed set with the teach pendant. Percentage value to the maximum speed is inputted.

F

F VARIABLE (Floating-point variable)

The variable which has a value of single precision real number (7 digits of effective precision).

FIG

The number which denotes the robot figure.

FIGURE

The possible status of each axis (joint) of the robot. Multiple figures are possible for the same position and posture.

FIGURE COMPONENT

The component which determine figure. There are five components in 6-axis robot; arm, elbow, wrist, the 6th axis and the 4th axis.

FIRST ARM

The robot arm nearest to the base.

FLIP

One of the wrist figures of 6-axis robot. (⇔ NONFLIP)

FUNCTION KEYS

The buttons provided under the pendant screen. Function names are displayed on the lower part of the screen and executes the function upon pressing the button.

G

GLOBAL VARIABLE

The variable available for any task.

H

HALT

The stop method to stop the program immediately. The motor power is not turned off.

HAND (end-effector)

The portion to hold the work. The same as tool.

HISTOGRAM

The occurrence ratio of the brightness value in a window. (Vision terms)

I

I VARIABLE (Integer variable)

The variable which has an integer value.

I/O

The input and/or output signal.

I/O COMMAND

The process command given by the external device through the I/O port. The robot controller processes according to this command.

INITIALIZATION FLOPPY DISK

The disk in which the initial setting of the robot at the factory shipment is recorded. It is used to recover to the initial condition when an error occurs in the controller memory.

INSTALLATION FRAME

The platform to install the robot.

INTERFERENCE AREA

The area provided by the user to watch if the tool interferes with the installation. If the origin of the tool coordinates enters into this area, output signal is issued from the specified I/O port.

INTERNAL ACCELERATION

The acceleration set in a program.

INTERNAL AUTOMATIC RUN

To execute a program from the operating panel or the teach pendant.

INTERNAL DECELERATION

The deceleration set in a program.

INTERNAL MODE

The mode in which robot run and teaching are possible using the operating panel or the teach pendant.

INTERNAL SPEED

The speed set in a program.

INTERRUPT SKIP

The input signal which halts the operation of the current step when it is ON during the execution of a robot command and starts the execution of the next step.

J

J VARIABLE (Joint variable)

The variable denoted by the value of each axis.

JOG DIAL

The dial on the pendant which is used to move cursor or to select a path on the input screen.

JOINT MODE

The mode in which the robot is manually operated on each axis.

L

LABELING

To number the binarized white and black area. (Vision terms)

LEFTY

One of the arm figures of 6-axis robot. (⇔ RIGHTY)

LIBRARY

The collection of programs for reuse. They are registered and utilized using the program bank of WINCAPSII.

LOAD

To read programs, arm data, etc. from the floppy disk into the robot controller.

LOAD CAPACITY

The mass of the sum of the tool and the work which the robot can hold.

LOCAL VARIABLE

The variable which is utilized within a task.

LOG

The record about operations, motions, etc. of the robot. There are four kinds of logs; error log, operation log, control log and communication log.

LOG MANAGER

The software which copies and manages the record of operations, errors, etc. of the robot in personal computer.

M

MACHINE LOCK

The state of simulating motion by the robot controller without actual robot motion.

MACRO

The definition of names with 12 characters in regard to variable numbers and port numbers. Names are replaced with numbers in program execution.

MACRO DEFINITION FILE

The file which defines macro.

MANUAL ROBOT OPERATION

Robot operation by the user using the operation keys of the teach pendant or the operating panel.

MECHANICAL END

The mechanical motion limit set by the mechanical stopper. (⇔ Software limit)

MECHANICAL INTERFACE

The junction surface of the flange and the tool. Mechanical interface (JIS)

MECHANICAL INTERFACE COORDINATES

Three dimensional orthogonal coordinate system which has the origin on the center of the flange.

MECHANICAL STOPPER

The mechanism to restrict the motion of the robot axes physically.

MENU TREE

The description of the functional menu of function keys in tree form. It is listed on the operational guide.

MODE METHOD

The method to set binarization level in the valley when the histogram is two hills distribution.

MODE SWITCH

The switch on the pendant. It can switch the robot run mode.

MONITOR

To display the current status of the robot.

MOTION SPACE

The range in which the robot can operate.

MULTITASKING

The state in which multiple programs are executed virtually simultaneously. It is realized in the way that CPU of the robot controller executes each program in a short interval by turns.

N

NLIM

The negative directional end value of the software limit. (⇔ PLIM)

NONFLIP

One of the wrist figures of 6-axis robot. (⇔ FLIP)

NORMAL MODE

The standard allocation mode of I/O.

NORMAL VECTOR

Positive directional vector of X-axis on the mechanical interface coordinates.

O

OPERATING MODE

The mode in which the robot is operated manually. There are three modes; each axis mode, X-Y mode and TOOL mode.

OPERATION LOG

The record of operations about the use of the teach pendant or the operating panel.

OPERATING PANEL

The fixed operating panel connected to the controller. It has no teaching function.

OPTIMAL LOAD CAPACITY SETTING FUNCTION

The function which sets the optimal speed and acceleration in response to the load condition or the posture of the robot.

ORIENT VECTOR

Positive directional vector of Y-axis on the mechanical interface coordinates.

OVERHEAD VERSION

The robot specified to install as it hangs from the ceiling setting the base above and the arm below. As the installation space is not needed on the working platform, working space could be wider.

Operator

One of the user levels of WINCAPSII. Important parameters cannot be changed. Password input is not necessary.

P

P TYLE METHOD

The binarization level setting method to make the area of the object and the area of the black (or white) portion to be the same. (Vision terms)

P VARIABLE (Position variable)

The variable denoted by the position, the posture and the figure.

PAC (PAC)

New robot language used in Denso robot. It is upward compatible from SLIM. (Industrial robot language of JIS)

PAC PROGRAM MANAGER

The software to support PAC program development. Editor, command builder and program bank functions are included.

PALLETIZING

To put in or take out parts, etc. to/from the pallet with partition.

PANEL OPERATION

To make ON/OFF operation of the internal I/O from the teach pendant screen.

PASS MOTION

The motion to pass near the motion target position set by teaching.

PENDANTLESS STATE

To run the robot from the external device when the operating panel or the teach pendant is not connected.

PITCH ANGLE

The rotational angle around Y-axis.

PIXEL

The point which forms the screen. □visual terms □

PLATE MECHANICAL INTERFACE

The portion to install tools located on the top end of the robot arm.

PLIM

The positive directional end value of the software limit. (□ NLIM)

POSITION DATA

The data of the base coordinates which describes the position of the robot flange center (the tool top end when the tool definition is effective) and the robot posture at the time.

POSTURE

The inclination of the tool determined by the roll, pitch and yaw angles in case of 6-axis robot. The tool direction determined by the angle around Z-axis in case of 4-axes robot.

POWERING OFF THE MOTER

To turn off the motor power of the robot.

POWERING OFF THE ROBOT CONTROLLER

To turn off the power of the robot controller.

POWERING ON THE MOTER

To turn on the motor power of the robot.

POWERING ON THE ROBOT CONTROLLER

To turn on the power of the robot controller.

PRINCIPAL AXIS

The axis which gives the minimum moment of inertia in case of rotating the object on a plane. (Vision terms)

PRINCIPAL AXIS ANGLE

The angle formed by the horizontal axis and the principal axis. (Vision terms)

PRIORITY

The sequence of task execution in order of importance. The program with higher priority is executed first.

PROGRAM RESET

The input signal to force program execution from the top of the program.

PROGRAM START

The input signal to start a program. When it is a step stop, execution begins from the next step and when it is a halt, execution begins from the following of the same step.

PROGRAM TRANSFER

To send/receive robot programs between the robot controller and WINCAPSII (PC).

PTP CONTROL

The control which moves the robot arm to the target position without compensation. The path may not necessarily be a straight line. (□ CP control)

Programmer

One of the user levels of WINCAPSII. All the common operations are possible. Password input is necessary to enter into this mode.

R

RANG

The angle which determines the relation of the robot standard position and the mechanical end.

RELATIVE MOTION

The motion to move from the current position for the motion amount set by teaching.

REMOTE OPERATION

To operate the robot arm which is displayed on the arm manager.

RIGHTY (RIGHTY)

One of the arm figures of 6-axis robot. (⇔ LEFTY)

ROBOT ERROR

The output signal which informs that an error condition occurred in the robot such as servo error, program error, etc.

ROBOT STOP

The stop method to stop programs immediately and power off the motor.

ROBOT WARNING

The output signal which informs that a slight error occurred during I/O command or servo processing.

ROLL ANGLE

The rotational angle around Z-axis.

RX COMPONENT

The amount of rotational angle around the X coordinate axis.

RY COMPONENT

The amount of rotational angle around the Y coordinate axis.

RZ COMPONENT

The amount of rotational angle around the Z coordinate axis.

S

SAVE

To save programs, arm data, etc. onto the floppy disk from the robot controller.

SEARCH

To search the space which coincides with a standardized image data (search model). □ Vision terms □

SECOND ARM

The farther arm of the robot arms measured from the base.

SEMAPHORE

The task execution privilege which is used to synchronize among tasks or to do exclusive control among the tasks that must not be executed simultaneously.

SERVO ON

The signal to inform to the outside that the motor power is on.

SET COMMUNICATION

To set the usage conditions (communication speed, etc.) of each communication port of the robot controller.

SET COMMUNICATION PERMISSION

To set the usage permission of each communication port of the robot controller.

SINGLE

One of the 6th axis figures of 6-axis robot. (⇔ DOUBLE □)

SINGLE-CYCLE START

The start method to make a program execute one cycle. The program stops after one cycle execution (to the last step of the program).

SINGLE-STEP START

The start method to make a program execute one step. The program stops after one step execution.

SINGLE4

One of the 4th axis figures of 6-axis robot. (⇔ DOUBLE4)

SINGULAR POINT

The position on the boundary of the two figures.

SNAPSHOT

The function to record the current status of the robot.

SOFTWARE LIMIT

The limit of the robot motion range determined by the software. (⇔ mechanical end)

STATUS AREA

A group of output signals to inform the result of I/O command processing. The status corresponding to the I/O command is set.

STEP CHECK

One step execution of a program in teach check mode.

STEP STOP

The stop method to stop a program after one step execution.

STOP KEY

One of the pendant buttons. Pressing the button makes all programs halt immediately.

STROBE SIGNAL

The input signal to instruct the start of I/O command processing.

SUBROUTINE

The program which describes a specific motion and is called from a portion of a main program.

SYSTEM I/O SIGNALS

The input/output signals fixed to the system in order to inform the run control or run condition to the outside.

SYSTEM MANAGER

The software which generally manages all the information of WINCAPSII.

SYSTEM PROJECT

Programs and related data groups which are managed by the system manager.

SYSTEM VARIABLE

The variable to check the system condition in a program.

T

T VARIABLE (Homogeneous transform matrix variable)

The variable denoted by the position vector, the orient vector, the approach vector and the figure.

TASK

The motion process formed by each program when multiple programs are managed their simultaneous execution.

TEACH CHECK

To check the motion by the program.

TEACHING

To input the necessary information for operation into the robot using the teach pendant.

TOOL

The portion of the robot which affects the work immediately. It is a synonym of end-effector (JIS).

TOOL COORDINATES

The coordinate system which sets the origin on the tool and offsets the origin of the mechanical interface coordinates to any point and rotates around each axis.

TOOL MODE

The manual operation mode on the tool coordinates.

TOOL0

A special form of tool definition that has origin offset zero, i.e. it implies the mechanical interface coordinates.

TYPE DECLARATION

To declare the type of variable in a program.

U

USER COORDINATES

The coordinate system which users can define.

USER I/O SIGNALS

The input/output signals controllable by the user program.

USER LEVEL

The class provided for users to keep data management security. Access to information or operation is restricted by each class.

V

VARIABLE TABLE

A group of data which are the pair of each port number and value retained by the controller.

VISUAL DEVICE

The device to provide the robot with necessary data by processing the images inputted from the camera.

VISUAL FUNCTION

The function to provide the robot control function with necessary data by processing the images inputted from the camera.

W

WINDOW

The space to process images. (Vision terms)

WORK COORDINATES

The three dimensional orthogonal coordinate system which sets the origin on the work to be processed by the robot.

WRIST FIGURE

The figure determined by the value of the 4th and the 5th axis of the 6-axis robot. There are two kinds of wrist figures; FLIP and NONFLIP.



X-Y MODE

The manual operation mode on the base coordinates.



YAW ANGLE

The rotational angle around X-axis.

SYMBOLS

μVision

Visual device manufactured by DENSO.

Appendix-2 Names of the robot controller parts

The figure and table given below show the names of the robot controller parts.

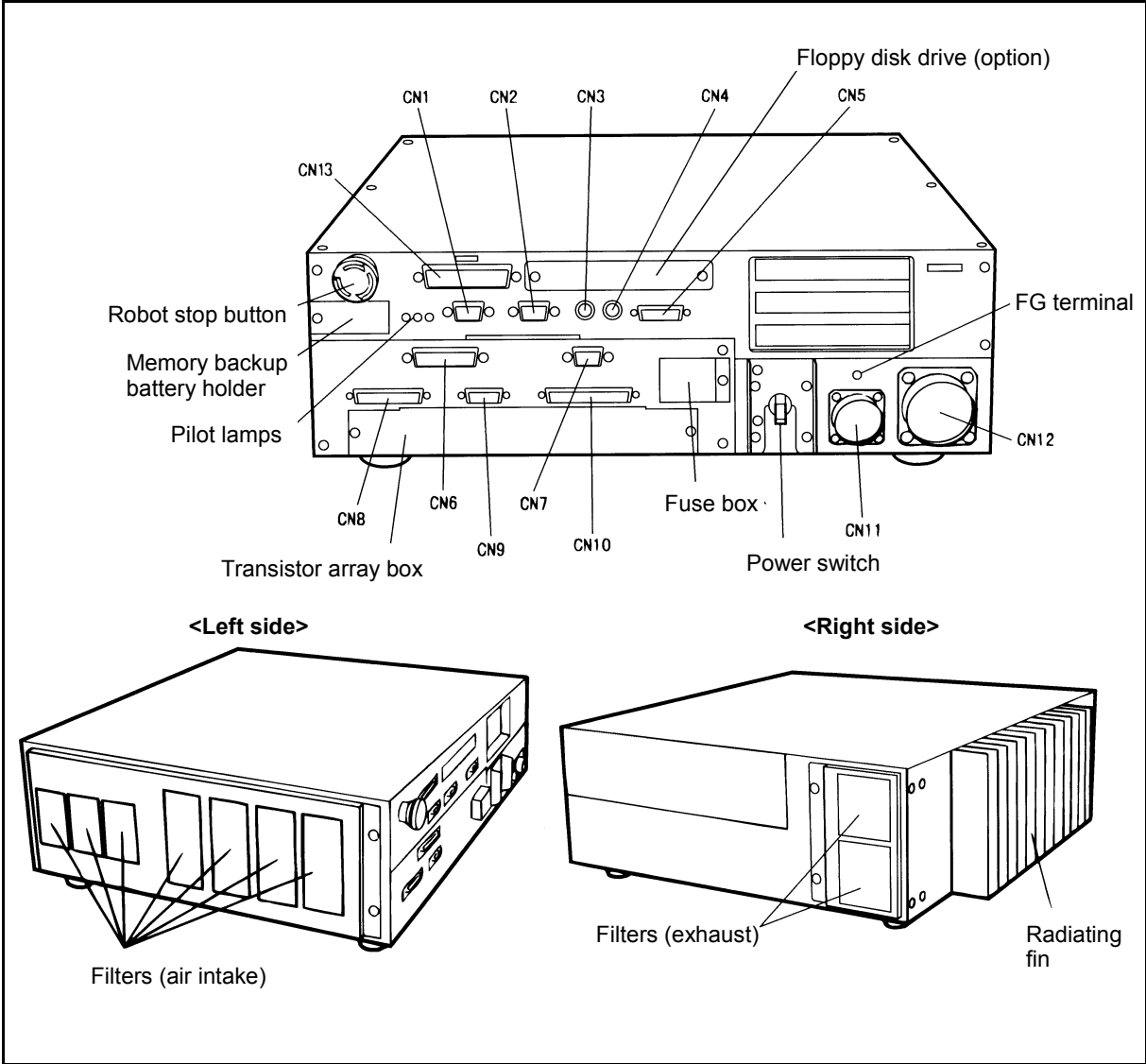

Names of Robot Controller Parts (VS-D series)

Connector Names (VS-D series)

Connector No.	Marking	Name	Connector No.	Marking	Name
CN1	RS232C	Serial interface connector	CN8	INPUT	Connector for user input or system input
CN2	CRT	Connector for CRT	CN9	HAND I/O	Connector for end-effector I/O
CN3	KEYBD	Connector for keyboard	CN10	OUTPUT	Connector for user output or system output
CN4	MOUSE	Connector for PS/2 mouse	CN11	INPUT AC	Power connector
CN5	PENDANT	Connector for pendant	CN12	MOTOR	Connector for motor
CN6	PRINTER	Connector for printer	CN13	ENCODER	Connector for encoder
CN7	I/O POWER	Power connector for I/O			

 **Caution:** The robot controller connectors are of a screw-lock type or ring-lock type. Lock the connectors securely. If even one of the connectors is not locked, incomplete contact may result thereby causing an error.

Connecting or disconnecting the power connector or motor connector when the robot controller power switch is ON may cause damage to the internal circuits of the robot controller. Turn OFF the power switch before connecting or disconnecting these connectors.

Appendix-3 Names of the teach pendant parts

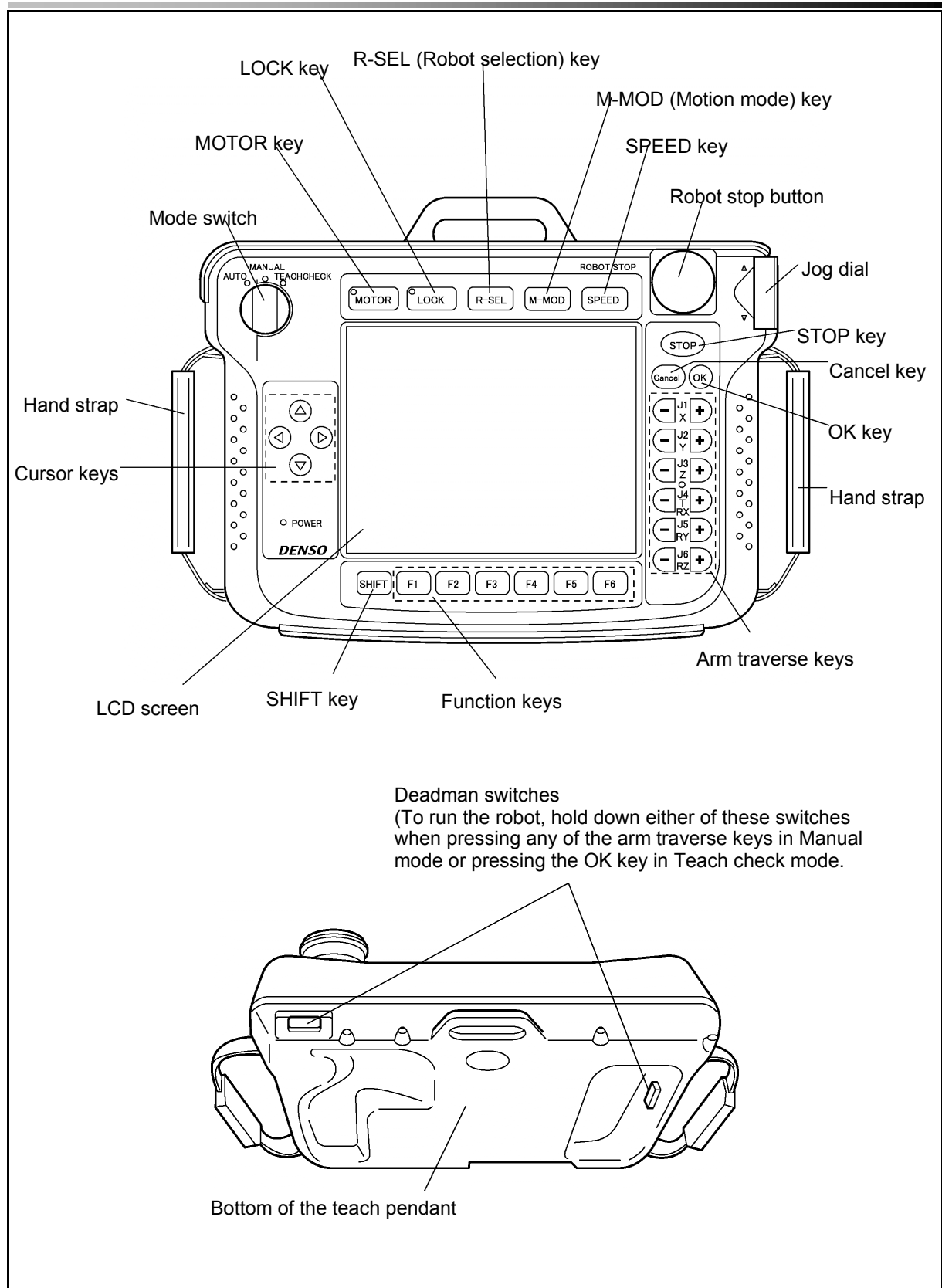

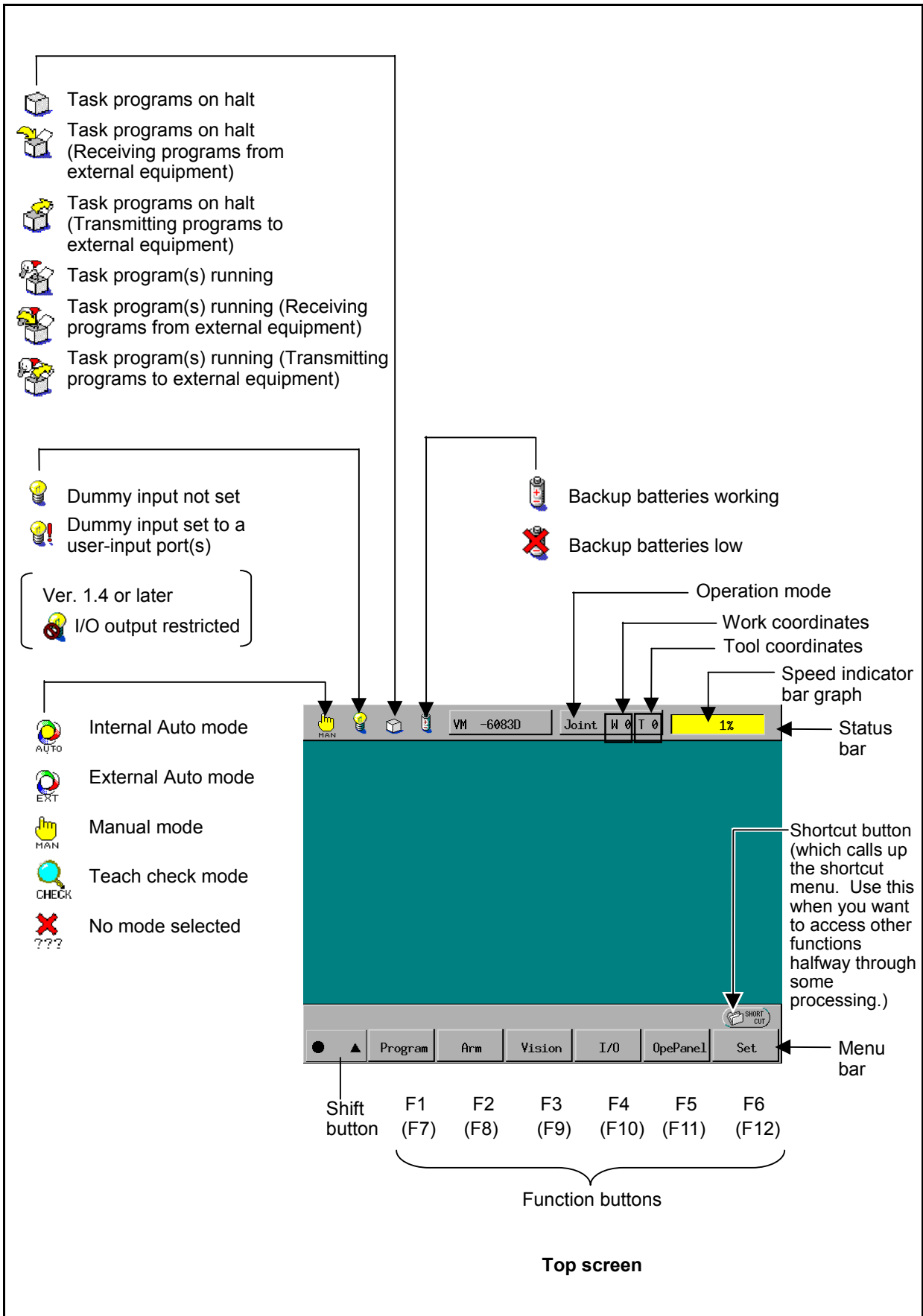

Appendix-4 Menu tree of the teach pendant

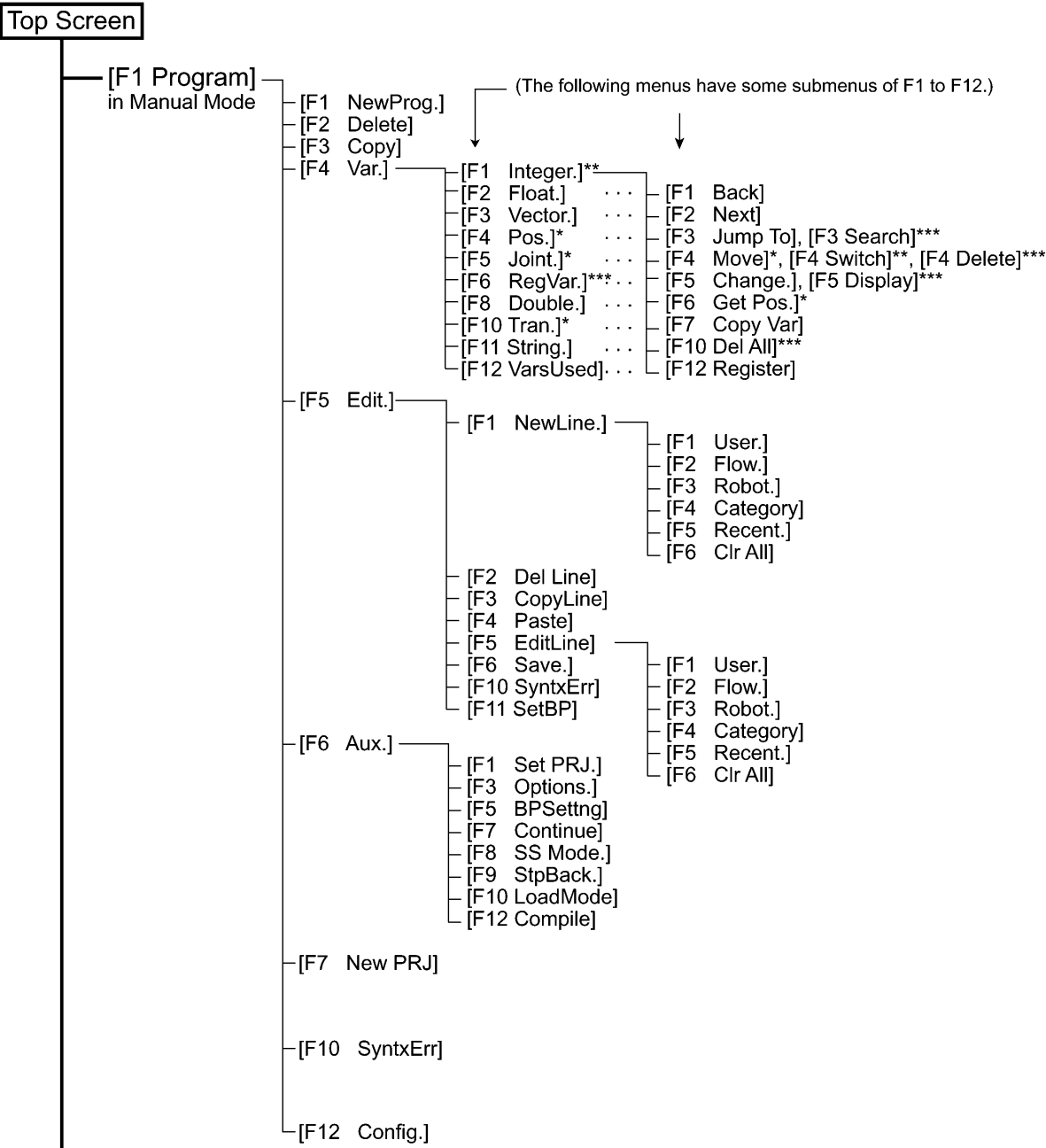

Next page

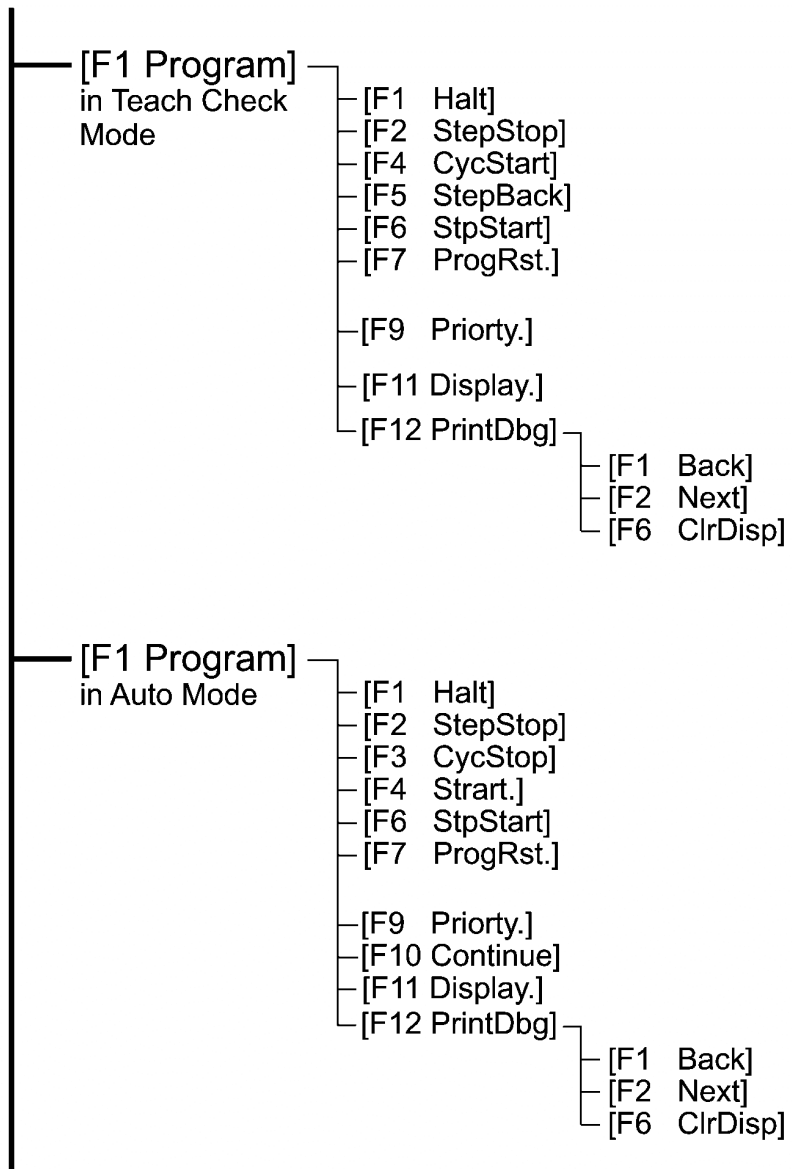

Next page

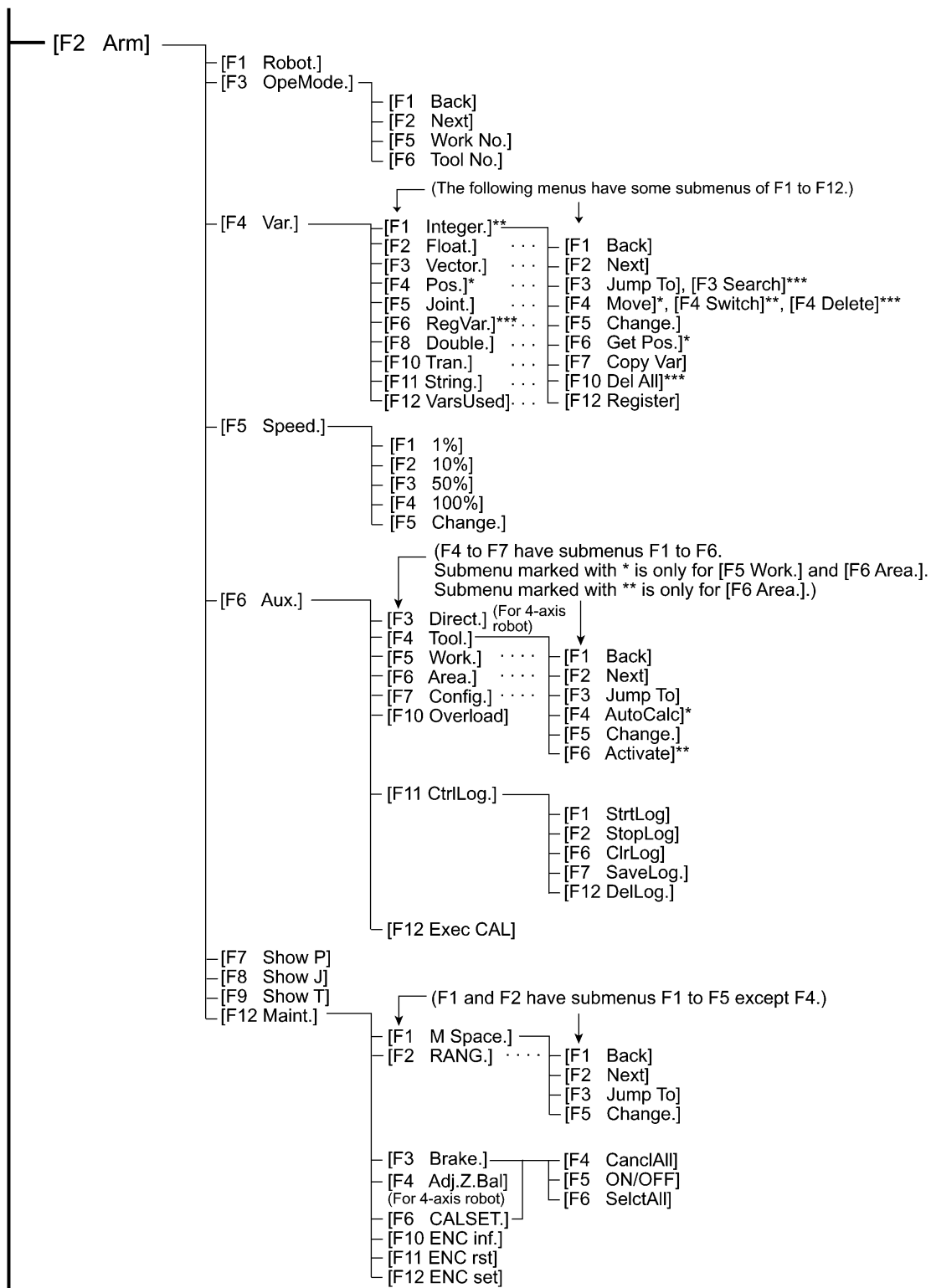

Next page

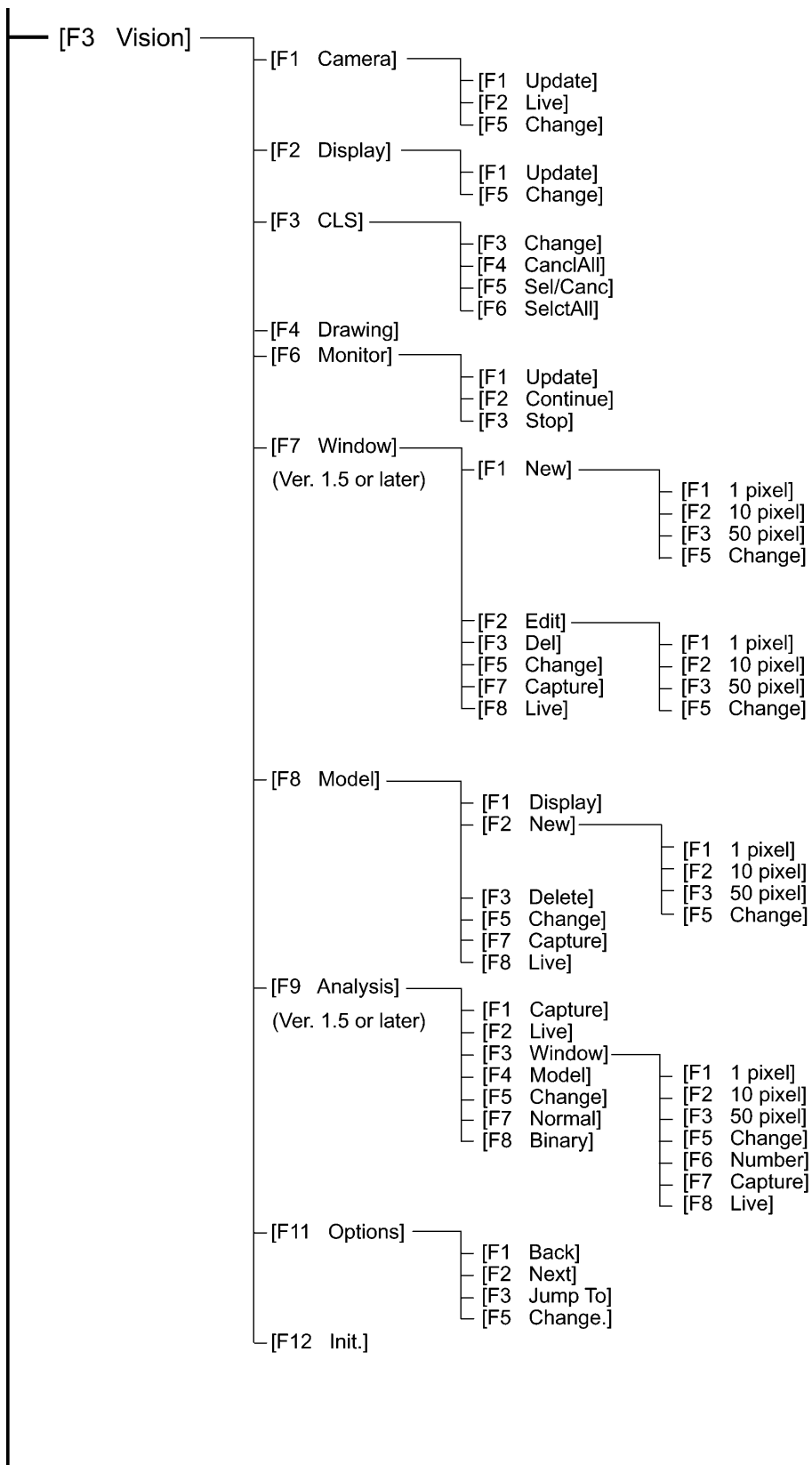

Next page

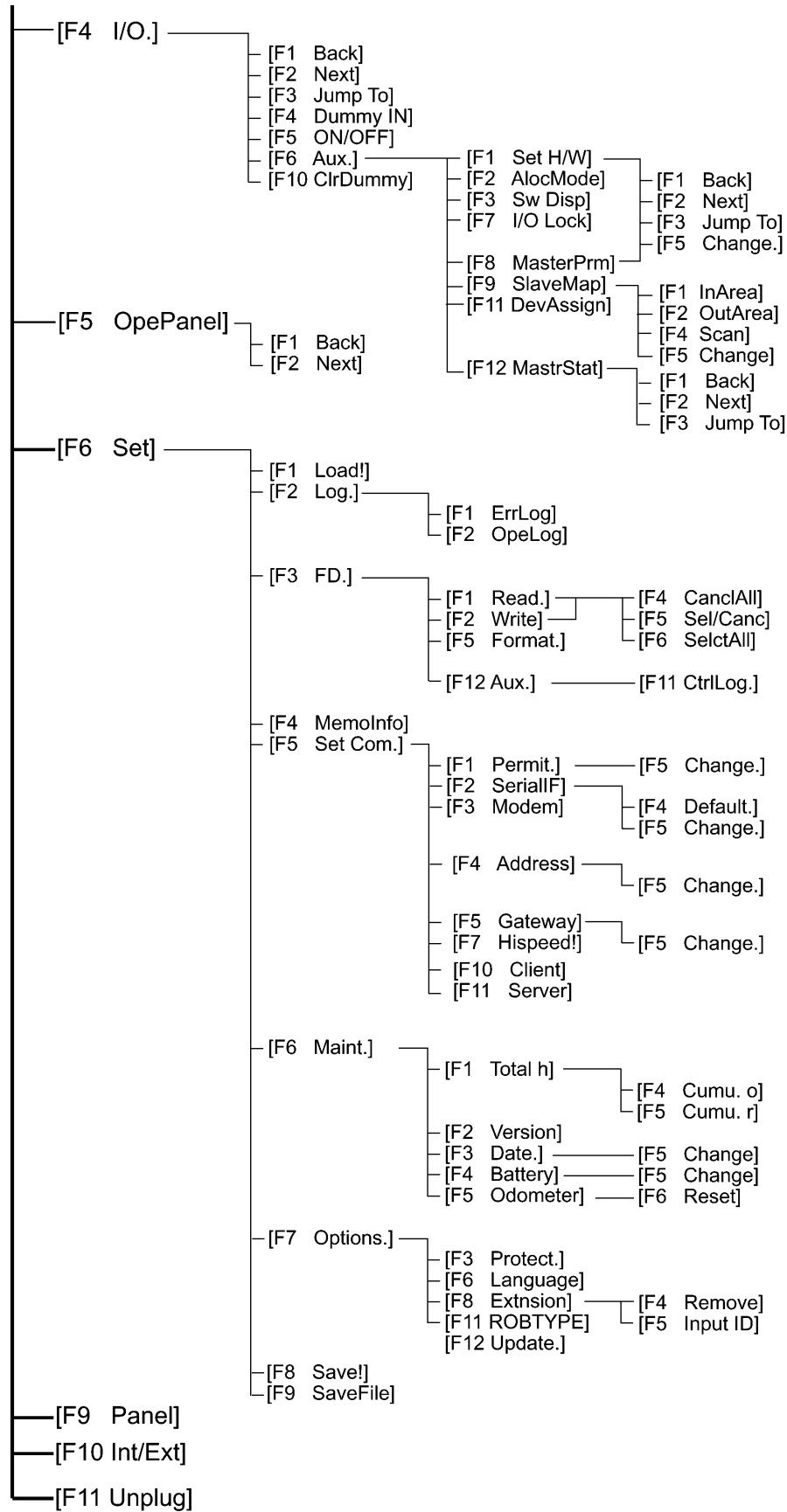

Vertical Articulated Robot

V*-D/-E SERIES

BEGINNER'S GUIDE

First Edition June 2000

Third Edition October 2001

DENSO WAVE INCORPORATED
Factory Automation Division

8D30C

The purpose of this manual is to provide accurate information in the handling and operating of the robot. Please feel free to send your comments regarding any errors or omissions you may have found, or any suggestions you may have for generally improving the manual.

In no event will DENSO WAVE INCORPORATED be liable for any direct or indirect damages resulting from the application of the information in this manual.

