

Synchronization: Advanced

15-213 / 18-213: Introduction to Computer Systems
25th Lecture, Nov. 22, 2016

Instructor:

Randy Bryant

Reminder: Semaphores

- ***Semaphore***: non-negative global integer synchronization variable
- **Manipulated by P and V operations:**
 - $P(s)$: [`while (s == 0) wait(); s--;`]
 - Dutch for "Proberen" (test)
 - $V(s)$: [`s++;`]
 - Dutch for "Verhogen" (increment)
- **OS kernel guarantees that operations between brackets [] are executed atomically**
 - Only one P or V operation at a time can modify s .
 - When `while` loop in P terminates, only that P can decrement s
- **Semaphore invariant: $(s \geq 0)$**

Review: Using semaphores to protect shared resources via mutual exclusion

■ Basic idea:

- Associate a unique semaphore *mutex*, initially 1, with each shared variable (or related set of shared variables)
- Surround each access to the shared variable(s) with $P(mutex)$ and $V(mutex)$ operations

```
mutex = 1
```

```
P(mutex)
```

```
cnt++
```

```
V(mutex)
```

Today

- **Using semaphores to schedule shared resources**
 - Producer-consumer problem
 - Readers-writers problem
- **Other concurrency issues**
 - Thread safety
 - Races
 - Deadlocks

Using Semaphores to Coordinate Access to Shared Resources

- **Basic idea: Thread uses a semaphore operation to notify another thread that some condition has become true**
 - Use counting semaphores to keep track of resource state.
 - Use binary semaphores to notify other threads.

- **Two classic examples:**
 - The Producer-Consumer Problem
 - The Readers-Writers Problem

Producer-Consumer Problem

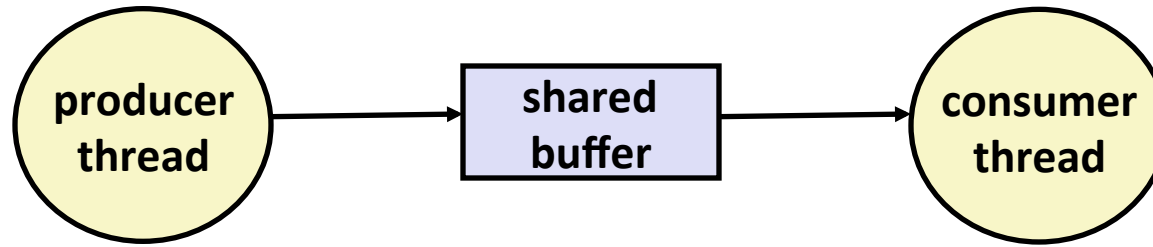

■ Common synchronization pattern:

- Producer waits for empty *slot*, inserts item in buffer, and notifies consumer
- Consumer waits for *item*, removes it from buffer, and notifies producer

■ Examples

- Multimedia processing:
 - Producer creates video frames, consumer renders them
- Event-driven graphical user interfaces
 - Producer detects mouse clicks, mouse movements, and keyboard hits and inserts corresponding events in buffer
 - Consumer retrieves events from buffer and paints the display

Producer-Consumer on 1-element Buffer

- Maintain two semaphores: `full` + `empty`

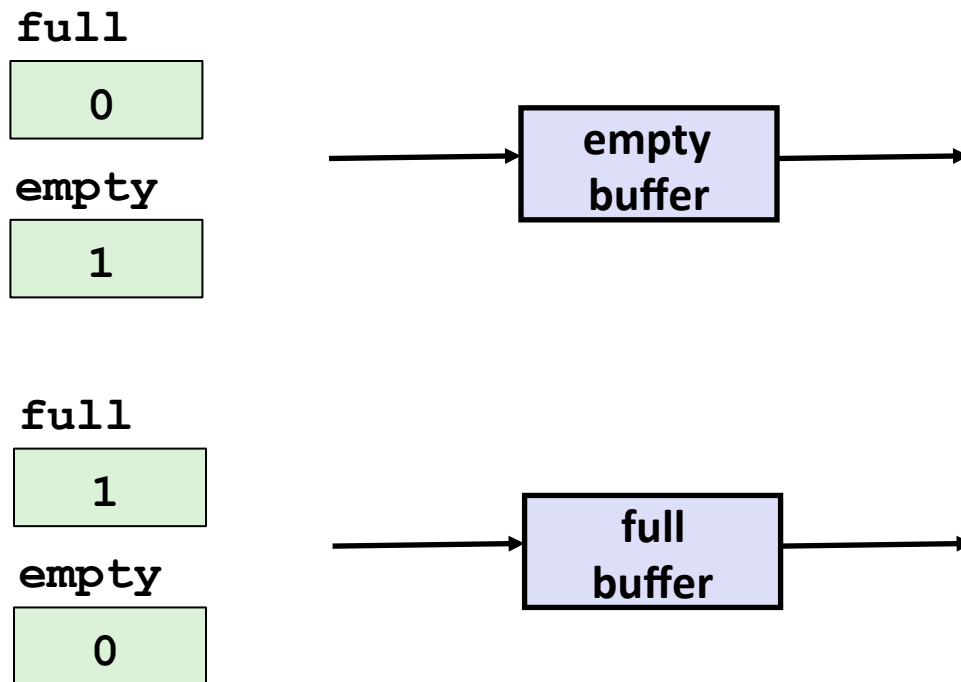

Producer-Consumer on 1-element Buffer

```
#include "csapp.h"

#define NITERS 5

void *producer(void *arg);
void *consumer(void *arg);

struct {
    int buf; /* shared var */
    sem_t full; /* sems */
    sem_t empty;
} shared;
```

```
int main(int argc, char** argv) {
    pthread_t tid_producer;
    pthread_t tid_consumer;

    /* Initialize the semaphores */
    Sem_init(&shared.empty, 0, 1);
    Sem_init(&shared.full, 0, 0);

    /* Create threads and wait */
    Pthread_create(&tid_producer, NULL,
                  producer, NULL);
    Pthread_create(&tid_consumer, NULL,
                  consumer, NULL);

    Pthread_join(tid_producer, NULL);
    Pthread_join(tid_consumer, NULL);

    return 0;
}
```

Producer-Consumer on 1-element Buffer

Initially: `empty==1, full==0`

Producer Thread

```
void *producer(void *arg) {
    int i, item;

    for (i=0; i<NITERS; i++) {
        /* Produce item */
        item = i;
        printf("produced %d\n",
            item);

        /* Write item to buf */
        P(&shared.empty);
        shared.buf = item;
        V(&shared.full);
    }
    return NULL;
}
```

Consumer Thread

```
void *consumer(void *arg) {
    int i, item;

    for (i=0; i<NITERS; i++) {
        /* Read item from buf */
        P(&shared.full);
        item = shared.buf;
        V(&shared.empty);

        /* Consume item */
        printf("consumed %d\n", item);
    }
    return NULL;
}
```

Why 2 Semaphores for 1-Entry Buffer?

- Consider multiple producers & multiple consumers

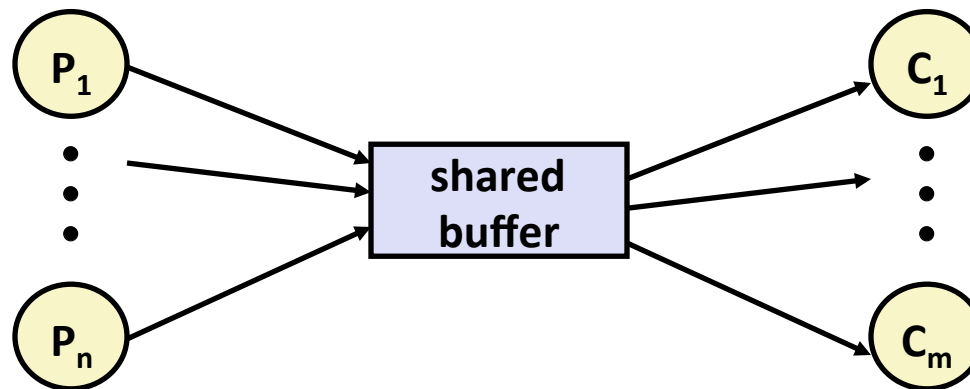

- Producers will contend with each to get **empty**
- Consumers will contend with each other to get **full**

Producers

```
P(&shared.empty);
shared.buf = item;
V(&shared.full);
```

empty

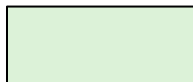

full



Consumers

```
P(&shared.full);
item = shared.buf;
V(&shared.empty);
```

Producer-Consumer on an n -element Buffer

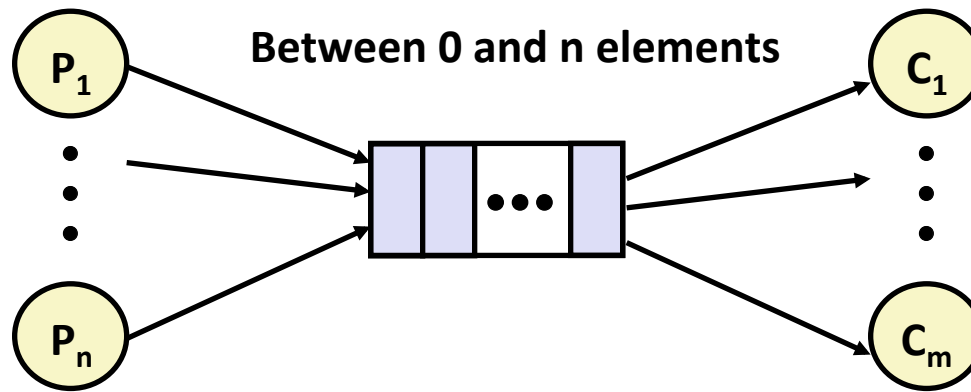

- Implemented using a shared buffer package called `sbuf`.

Circular Buffer (n = 10)

- Store elements in array of size n
- items: number of elements in buffer
- Empty buffer:
 - front = rear
- Nonempty buffer
 - rear: index of most recently inserted element
 - front: index of next element to remove - 1 (mod n)
- Initially:

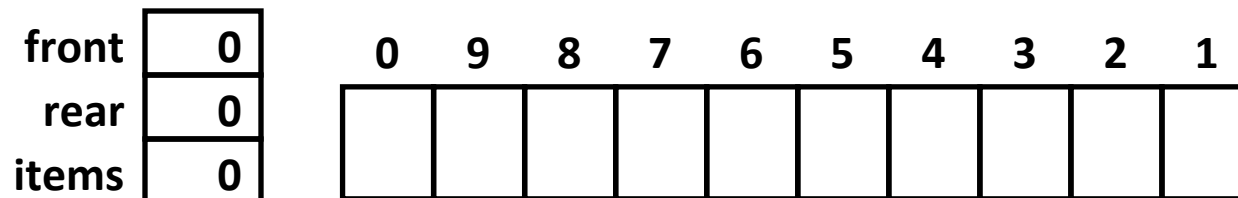

Circular Buffer Operation (n = 10)

■ Insert 7 elements

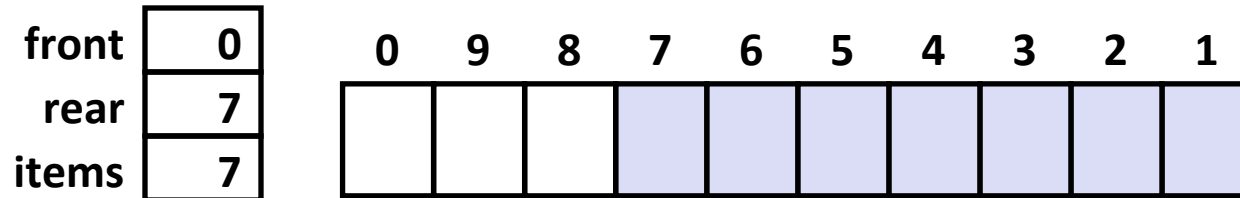

■ Remove 5 elements

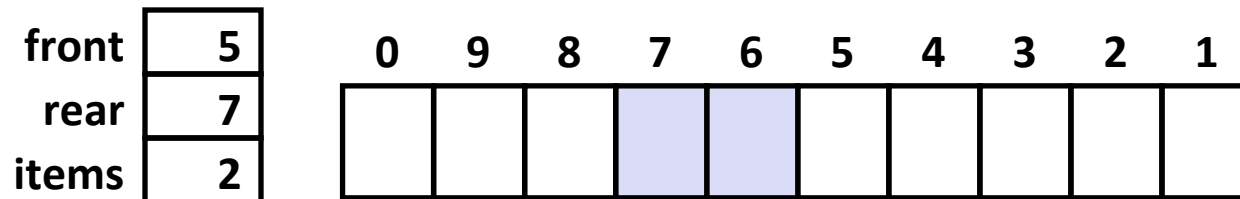

■ Insert 6 elements

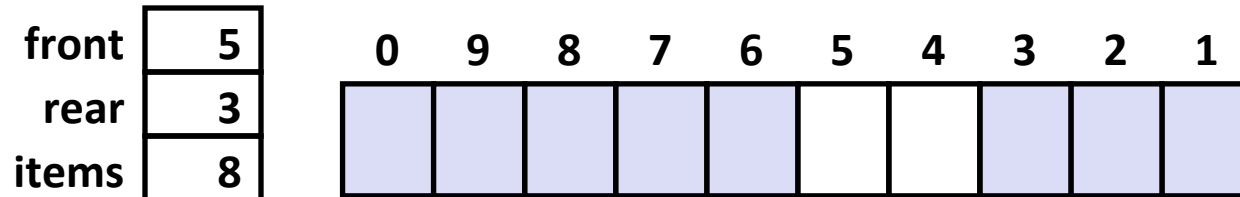

■ Remove 8 elements

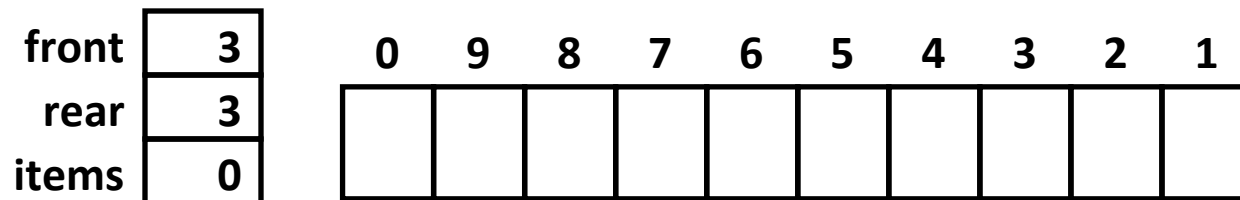

Sequential Circular Buffer Code

```
init(int v)
{
    items = front = rear = 0;
}

insert(int v)
{
    if (items >= n)
        error();
    if (++rear >= n) rear = 0;
    buf[rear] = v;
    items++;
}

int remove()
{
    if (items == 0)
        error();
    if (++front >= n) front = 0;
    int v = buf[front];
    items--;
    return v;
}
```

Producer-Consumer on an n -element Buffer

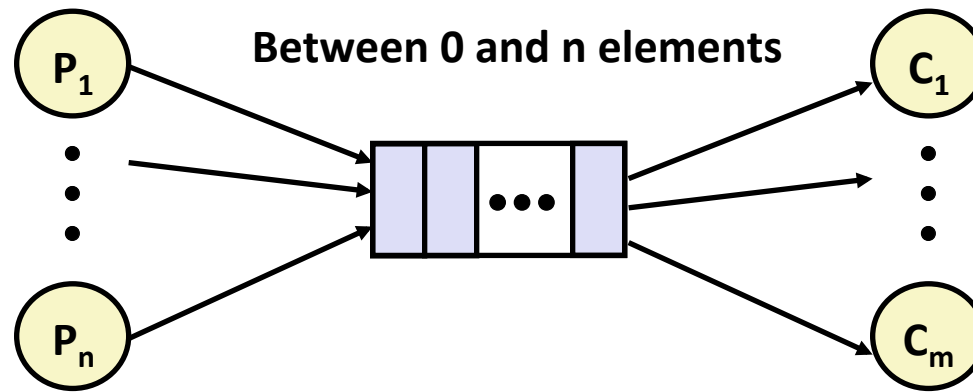

- **Requires a mutex and two counting semaphores:**
 - `mutex`: enforces mutually exclusive access to the buffer and counters
 - `slots`: counts the available slots in the buffer
 - `items`: counts the available items in the buffer
- **Makes use of general semaphores**
 - Will range in value from 0 to n

sbuf Package - Declarations

```
#include "csapp.h"

typedef struct {
    int *buf;          /* Buffer array */
    int n;            /* Maximum number of slots */
    int front;        /* buf[front+1 (mod n)] is first item */
    int rear;         /* buf[rear] is last item */
    sem_t mutex;     /* Protects accesses to buf */
    sem_t slots;     /* Counts available slots */
    sem_t items;     /* Counts available items */
} sbuf_t;

void sbuf_init(sbuf_t *sp, int n);
void sbuf_deinit(sbuf_t *sp);
void sbuf_insert(sbuf_t *sp, int item);
int sbuf_remove(sbuf_t *sp);
```

sbuf.h

sbuf Package - Implementation

Initializing and deinitializing a shared buffer:

```
/* Create an empty, bounded, shared FIFO buffer with n slots */
void sbuf_init(sbuf_t *sp, int n)
{
    sp->buf = Calloc(n, sizeof(int));
    sp->n = n; /* Buffer holds max of n items */
    sp->front = sp->rear = 0; /* Empty buffer iff front == rear */
    Sem_init(&sp->mutex, 0, 1); /* Binary semaphore for locking */
    Sem_init(&sp->slots, 0, n); /* Initially, buf has n empty slots */
    Sem_init(&sp->items, 0, 0); /* Initially, buf has zero items */
}

/* Clean up buffer sp */
void sbuf_deinit(sbuf_t *sp)
{
    Free(sp->buf);
}
```

sbuf.c

sbuf Package - Implementation

Inserting an item into a shared buffer:

```
/* Insert item onto the rear of shared buffer sp */
void sbuf_insert(sbuf_t *sp, int item)
{
    P(&sp->slots);          /* Wait for available slot */
    P(&sp->mutex);          /* Lock the buffer          */
    if (++sp->rear >= sp->n) /* Increment index (mod n) */
        sp->rear = 0;
    sp->buf[sp->rear] = item; /* Insert the item          */
    V(&sp->mutex);          /* Unlock the buffer        */
    V(&sp->items);          /* Announce available item */
}
```

sbuf.c

sbuf Package - Implementation

Removing an item from a shared buffer:

```
/* Remove and return the first item from buffer sp */
int sbuf_remove(sbuf_t *sp)
{
    int item;
    P(&sp->items);          /* Wait for available item */
    P(&sp->mutex);          /* Lock the buffer */
    if (++sp->front >= sp->n) /* Increment index (mod n) */
        sp->front = 0;
    item = sp->buf[sp->front]; /* Remove the item */
    V(&sp->mutex);          /* Unlock the buffer */
    V(&sp->slots);         /* Announce available slot */
    return item;
}
```

sbuf.c

Demonstration

- See program `produce-consume.c` in code directory
- 10-entry shared circular buffer
- 5 producers
 - Agent i generates numbers from $20*i$ to $20*i - 1$.
 - Puts them in buffer
- 5 consumers
 - Each retrieves 20 elements from buffer
- Main program
 - Makes sure each value between 0 and 99 retrieved once

Today

- **Using semaphores to schedule shared resources**
 - Producer-consumer problem
 - **Readers-writers problem**
- **Other concurrency issues**
 - Thread safety
 - Races
 - Deadlocks

Readers-Writers Problem

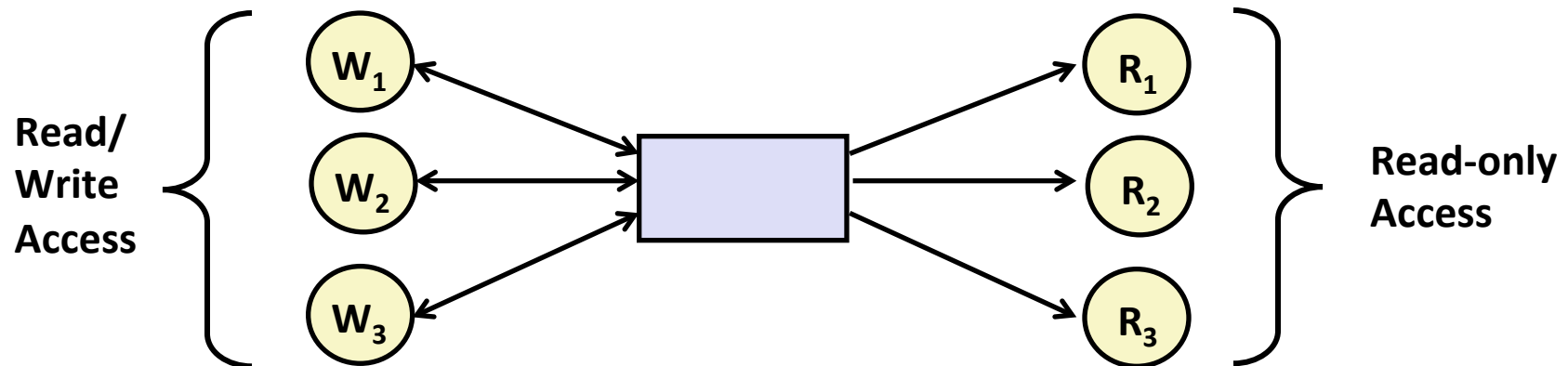

■ Problem statement:

- *Reader* threads only read the object
- *Writer* threads modify the object (read/write access)
- Writers must have exclusive access to the object
- Unlimited number of readers can access the object

■ Occurs frequently in real systems, e.g.,

- Online airline reservation system
- Multithreaded caching Web proxy

Readers/Writers Examples

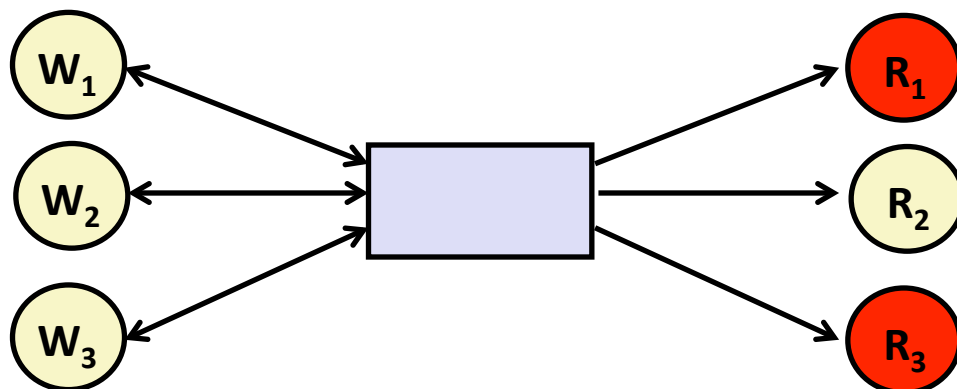
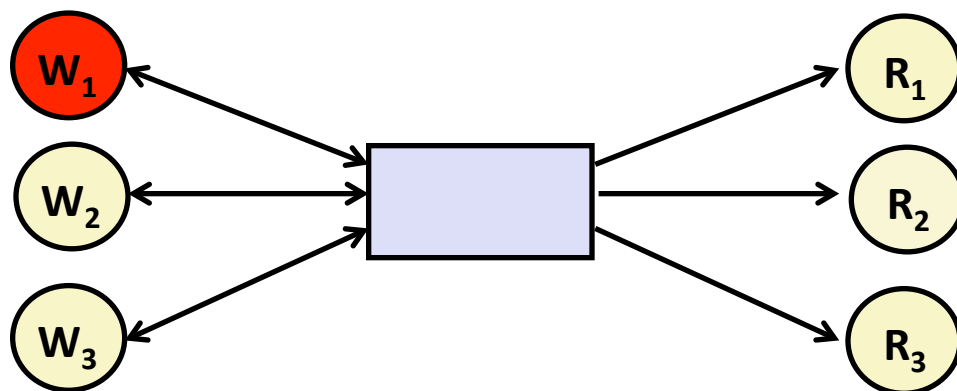

Variants of Readers-Writers

- ***First readers-writers problem (favors readers)***
 - No reader should be kept waiting unless a writer has already been granted permission to use the object.
 - A reader that arrives after a waiting writer gets priority over the writer.

- ***Second readers-writers problem (favors writers)***
 - Once a writer is ready to write, it performs its write as soon as possible
 - A reader that arrives after a writer must wait, even if the writer is also waiting.

- ***Starvation (where a thread waits indefinitely) is possible in both cases.***

Solution to First Readers-Writers Problem

Readers:

```
int readcnt;    /* Initially 0 */
sem_t mutex, w; /* Both initially 1 */

void reader(void)
{
    while (1) {
        P(&mutex);
        readcnt++;
        if (readcnt == 1) /* First in */
            P(&w);
        V(&mutex);

        /* Reading happens here */

        P(&mutex);
        readcnt--;
        if (readcnt == 0) /* Last out */
            V(&w);
        V(&mutex);
    }
}
```

Writers:

```
void writer(void)
{
    while (1) {
        P(&w);

        /* Writing here */

        V(&w);
    }
}
```

rw1.c

Readers/Writers Examples

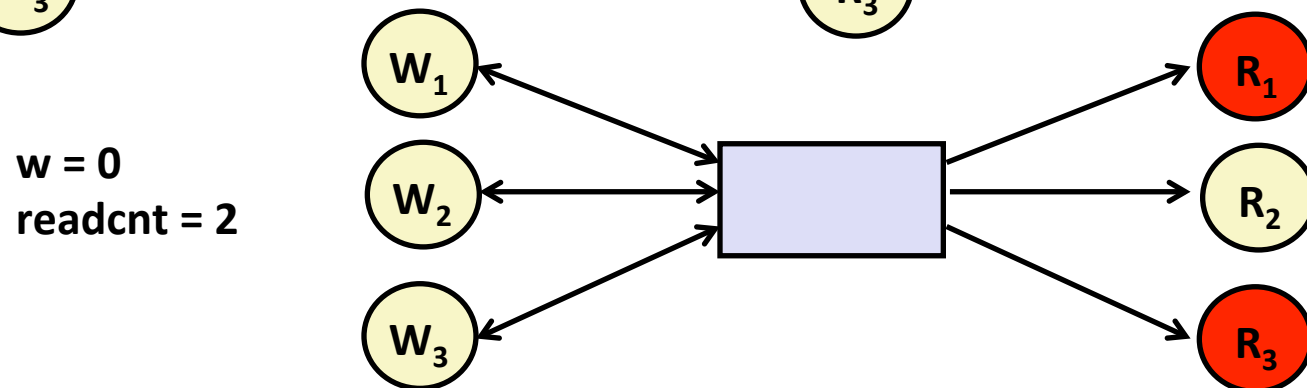
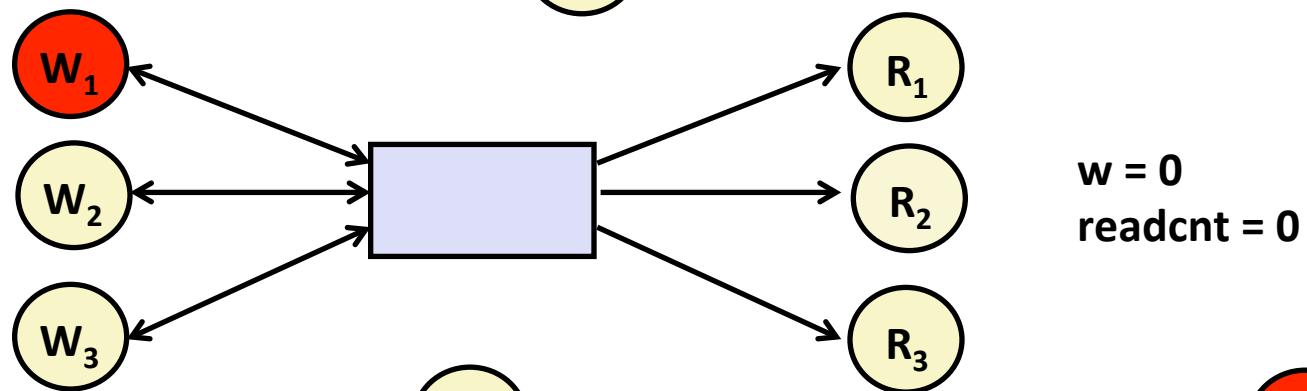
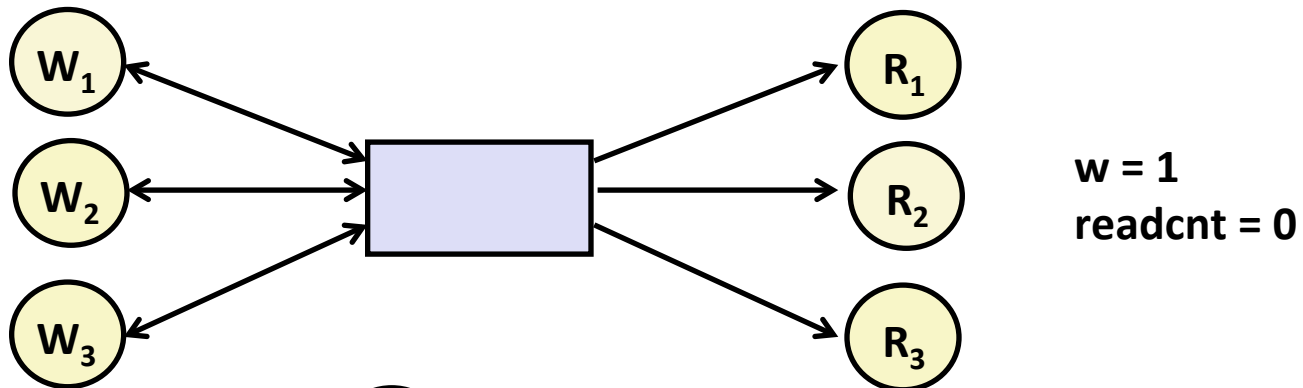

Solution to First Readers-Writers Problem

Readers:

```

int readcnt;    /* Initially 0 */
sem_t mutex, w; /* Both initially 1 */

void reader(void)
{
    while (1) {
        P(&mutex);
        readcnt++;
        if (readcnt == 1) /* First in */
            P(&w);
        V(&mutex);

        /* Reading happens here */

        P(&mutex);
        readcnt--;
        if (readcnt == 0) /* Last out */
            V(&w);
        V(&mutex);
    }
}

```

Writers:

```

void writer(void)
{
    while (1) {
        P(&w);

        /* Writing here */

        V(&w);
    }
}

```

rw1.c

Arrivals: R1 R2 W1 R3

Solution to First Readers-Writers Problem

Readers:

```

int readcnt;    /* Initially 0 */
sem_t mutex, w; /* Both initially 1 */

void reader(void)
{
    while (1) {
        P(&mutex);
        readcnt++;
        if (readcnt == 1) /* First in */
            P(&w);
        V(&mutex);

        /* Reading happens here */

        P(&mutex);
        readcnt--;
        if (readcnt == 0) /* Last out */
            V(&w);
        V(&mutex);
    }
}

```

R1



Writers:

```

void writer(void)
{
    while (1) {
        P(&w);

        /* Writing here */

        V(&w);
    }
}

```

rw1.c

Arrivals: R1 R2 W1 R3

Readcnt == 1

W == 0

Solution to First Readers-Writers Problem

Readers:

```

int readcnt;    /* Initially 0 */
sem_t mutex, w; /* Both initially 1 */

void reader(void)
{
    while (1) {
        P(&mutex);
        readcnt++;
        R2 → if (readcnt == 1) /* First in */
            P(&w);
            V(&mutex);

        R1 → /* Reading happens here */

        P(&mutex);
        readcnt--;
        if (readcnt == 0) /* Last out */
            V(&w);
        V(&mutex);
    }
}

```

Writers:

```

void writer(void)
{
    while (1) {
        P(&w);

        /* Writing here */

        V(&w);
    }
}

```

rw1.c

Arrivals: R1 R2 W1 R3

Readcnt == 2
W == 0

Solution to First Readers-Writers Problem

Readers:

```

int readcnt;    /* Initially 0 */
sem_t mutex, w; /* Both initially 1 */

void reader(void)
{
    while (1) {
        P(&mutex);
        readcnt++;
        if (readcnt == 1) /* First in */
            P(&w);
        V(&mutex);

        /* Reading happens here */

        P(&mutex);
        readcnt--;
        if (readcnt == 0) /* Last out */
            V(&w);
        V(&mutex);
    }
}

```

R2
R1



Writers:

```

void writer(void)
{
    while (1) {
        P(&w);
        /* Writing here */
        V(&w);
    }
}

```

← W1

rw1.c

Arrivals: R1 R2 W1 R3

Readcnt == 2

W == 0

Solution to First Readers-Writers Problem

Readers:

```

int readcnt;    /* Initially 0 */
sem_t mutex, w; /* Both initially 1 */

void reader(void)
{
    while (1) {
        P(&mutex);
        readcnt++;
        if (readcnt == 1) /* First in */
            P(&w);
        V(&mutex);

        /* Reading happens here */

        P(&mutex);
        readcnt--;
        if (readcnt == 0) /* Last out */
            V(&w);
        V(&mutex);
    }
}

```

R2



R1



Writers:

```

void writer(void)
{
    while (1) {
        P(&w);
        /* Writing here */
        V(&w);
    }
}

```

← W1

rw1.c

Arrivals: R1 R2 W1 R3

Readcnt == 1

W == 0

Solution to First Readers-Writers Problem

Readers:

```

int readcnt;    /* Initially 0 */
sem_t mutex, w; /* Both initially 1 */

void reader(void)
{
    while (1) {
        P(&mutex);
        readcnt++;
        R3 → if (readcnt == 1) /* First in */
            P(&w);
            V(&mutex);

        /* Reading happens here */

        R2 → P(&mutex);
            readcnt--;
            if (readcnt == 0) /* Last out */
                V(&w);
            V(&mutex);

        R1 → }
    }

```

Writers:

```

void writer(void)
{
    while (1) { ← W1
        P(&w);

        /* Writing here */

        V(&w);
    }
}

```

rw1.c

Arrivals: R1 R2 W1 R3

Readcnt == 2

W == 0

Solution to First Readers-Writers Problem

Readers:

```

int readcnt;    /* Initially 0 */
sem_t mutex, w; /* Both initially 1 */

void reader(void)
{
    while (1) {
        P(&mutex);
        readcnt++;
        if (readcnt == 1) /* First in */
            P(&w);
        V(&mutex);

        /* Reading happens here */

        P(&mutex);
        readcnt--;
        if (readcnt == 0) /* Last out */
            V(&w);
        V(&mutex);
    }
}

```

R3 →

R2 →

Writers:

```

void writer(void)
{
    while (1) { ← W1
        P(&w);

        /* Writing here */

        V(&w);
    }
}

```

rw1.c

Arrivals: R1 R2 W1 R3

Readcnt == 1

W == 0

Solution to First Readers-Writers Problem

Readers:

```

int readcnt;    /* Initially 0 */
sem_t mutex, w; /* Both initially 1 */

void reader(void)
{
    while (1) {
        P(&mutex);
        readcnt++;
        if (readcnt == 1) /* First in */
            P(&w);
        V(&mutex);

        /* Reading happens here */

        P(&mutex);
        readcnt--;
        if (readcnt == 0) /* Last out */
            V(&w);
        V(&mutex);
    }
}

```

R3 →

Writers:

```

void writer(void)
{
    while (1) { ← W1
        P(&w);

        /* Writing here */

        V(&w);
    }
}

```

rw1.c

Arrivals: R1 R2 W1 R3

Readcnt == 0

W == 1

Demonstration

- See program `read-write.c`
- 100 agents
 - ~20% are writers. They write their ID to global variable
 - Rest are readers. They read the global variable

Today

- **Using semaphores to schedule shared resources**
 - Producer-consumer problem
 - Readers-writers problem
- **Other concurrency issues**
 - **Races**
 - Deadlocks
 - Thread safety

One Worry: Races

- A *race* occurs when correctness of the program depends on one thread reaching point x before another thread reaches point y

```
/* a threaded program with a race */
int main(int argc, char** argv) {
    pthread_t tid[N];
    int i;
    for (i = 0; i < N; i++)
        Pthread_create(&tid[i], NULL, thread, &i);
    for (i = 0; i < N; i++)
        Pthread_join(tid[i], NULL);
    return 0;
}

/* thread routine */
void *thread(void *vargp) {
    int myid = *((int *)vargp);
    printf("Hello from thread %d\n", myid);
    return NULL;
}
```

race.c

Data Race

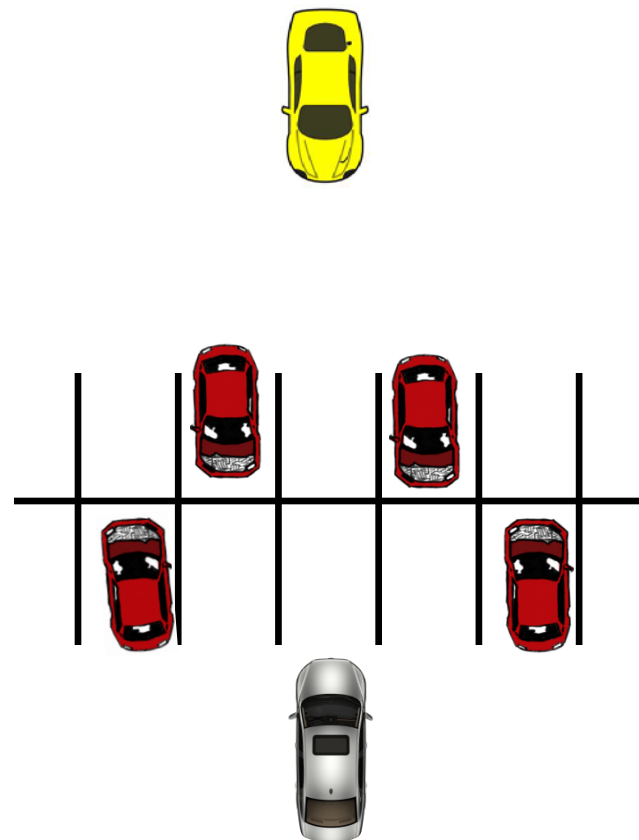

Race Elimination

- Make sure don't have unintended sharing of state

```
/* a threaded program without the race */
int main(int argc, char** argv) {
    pthread_t tid[N];
    int i;
    for (i = 0; i < N; i++) {
        int *valp = Malloc(sizeof(int));
        *valp = i;
        Pthread_create(&tid[i], NULL, thread, valp);
    }
    for (i = 0; i < N; i++)
        Pthread_join(tid[i], NULL);
    return 0;
}

/* thread routine */
void *thread(void *vargp) {
    int myid = *((int *)vargp);
    Free(vargp);
    printf("Hello from thread %d\n", myid);
    return NULL;
}
norace.c
```

Today

- **Using semaphores to schedule shared resources**
 - Producer-consumer problem
 - Readers-writers problem
- **Other concurrency issues**
 - Races
 - **Deadlocks**
 - Thread safety

A Worry: Deadlock

- Def: A process is *deadlocked* iff it is waiting for a condition that will never be true.

- Typical Scenario
 - Processes 1 and 2 needs two resources (A and B) to proceed
 - Process 1 acquires A, waits for B
 - Process 2 acquires B, waits for A
 - Both will wait forever!

Deadlocking With Semaphores

```

int main(int argc, char** argv)
{
    pthread_t tid[2];
    Sem_init(&mutex[0], 0, 1);  /* mutex[0] = 1 */
    Sem_init(&mutex[1], 0, 1);  /* mutex[1] = 1 */
    Pthread_create(&tid[0], NULL, count, (void*) 0);
    Pthread_create(&tid[1], NULL, count, (void*) 1);
    Pthread_join(tid[0], NULL);
    Pthread_join(tid[1], NULL);
    printf("cnt=%d\n", cnt);
    return 0;
}

```

```

void *count(void *vargp)
{
    int i;
    int id = (int) vargp;
    for (i = 0; i < NITERS; i++) {
        P(&mutex[id]); P(&mutex[1-id]);
        cnt++;
        V(&mutex[id]); V(&mutex[1-id]);
    }
    return NULL;
}

```

```

Tid[0]:
P(s0);
P(s1);
cnt++;
V(s0);
V(s1);

```

```

Tid[1]:
P(s1);
P(s0);
cnt++;
V(s1);
V(s0);

```

Deadlock Visualized in Progress Graph

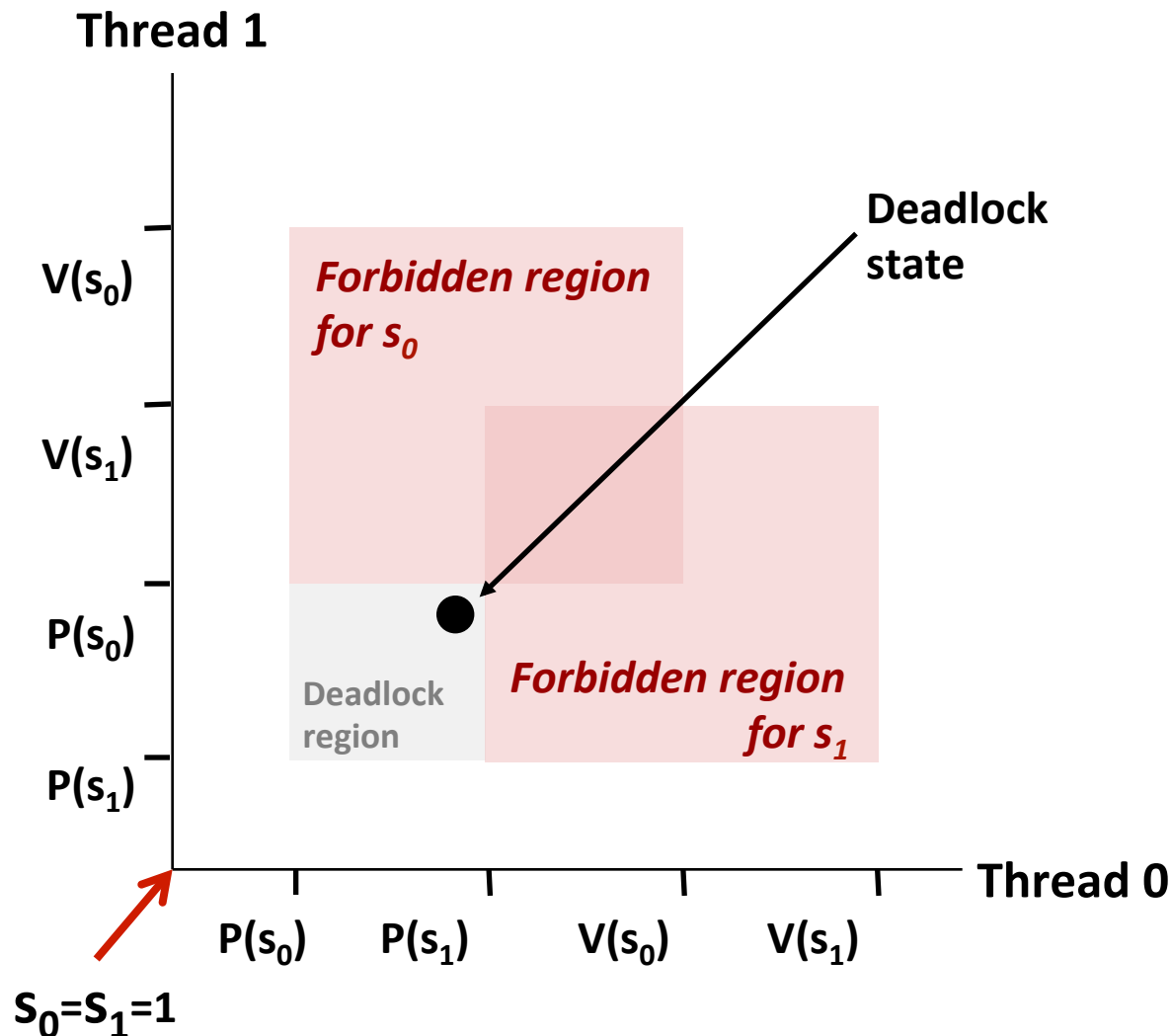

Locking introduces the potential for **deadlock**: waiting for a condition that will never be true

Any trajectory that enters the **deadlock region** will eventually reach the **deadlock state**, waiting for either s_0 or s_1 to become nonzero

Other trajectories luck out and skirt the deadlock region

Unfortunate fact: deadlock is often nondeterministic (race)

Deadlock

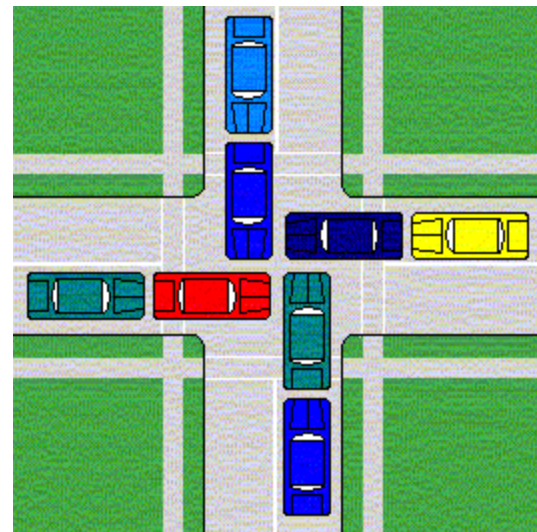

Avoiding Deadlock

Acquire shared resources in same order

```
int main(int argc, char** argv)
{
    pthread_t tid[2];
    Sem_init(&mutex[0], 0, 1);  /* mutex[0] = 1 */
    Sem_init(&mutex[1], 0, 1);  /* mutex[1] = 1 */
    Pthread_create(&tid[0], NULL, count, (void*) 0);
    Pthread_create(&tid[1], NULL, count, (void*) 1);
    Pthread_join(tid[0], NULL);
    Pthread_join(tid[1], NULL);
    printf("cnt=%d\n", cnt);
    return 0;
}
```

```
void *count(void *vargp)
{
    int i;
    int id = (int) vargp;
    for (i = 0; i < NITERS; i++) {
        P(&mutex[0]); P(&mutex[1]);
        cnt++;
        V(&mutex[id]); V(&mutex[1-id]);
    }
    return NULL;
}
```

```
Tid[0]:
P(s0);
P(s1);
cnt++;
V(s0);
V(s1);
```

```
Tid[1]:
P(s0);
P(s1);
cnt++;
V(s1);
V(s0);
```

Avoided Deadlock in Progress Graph

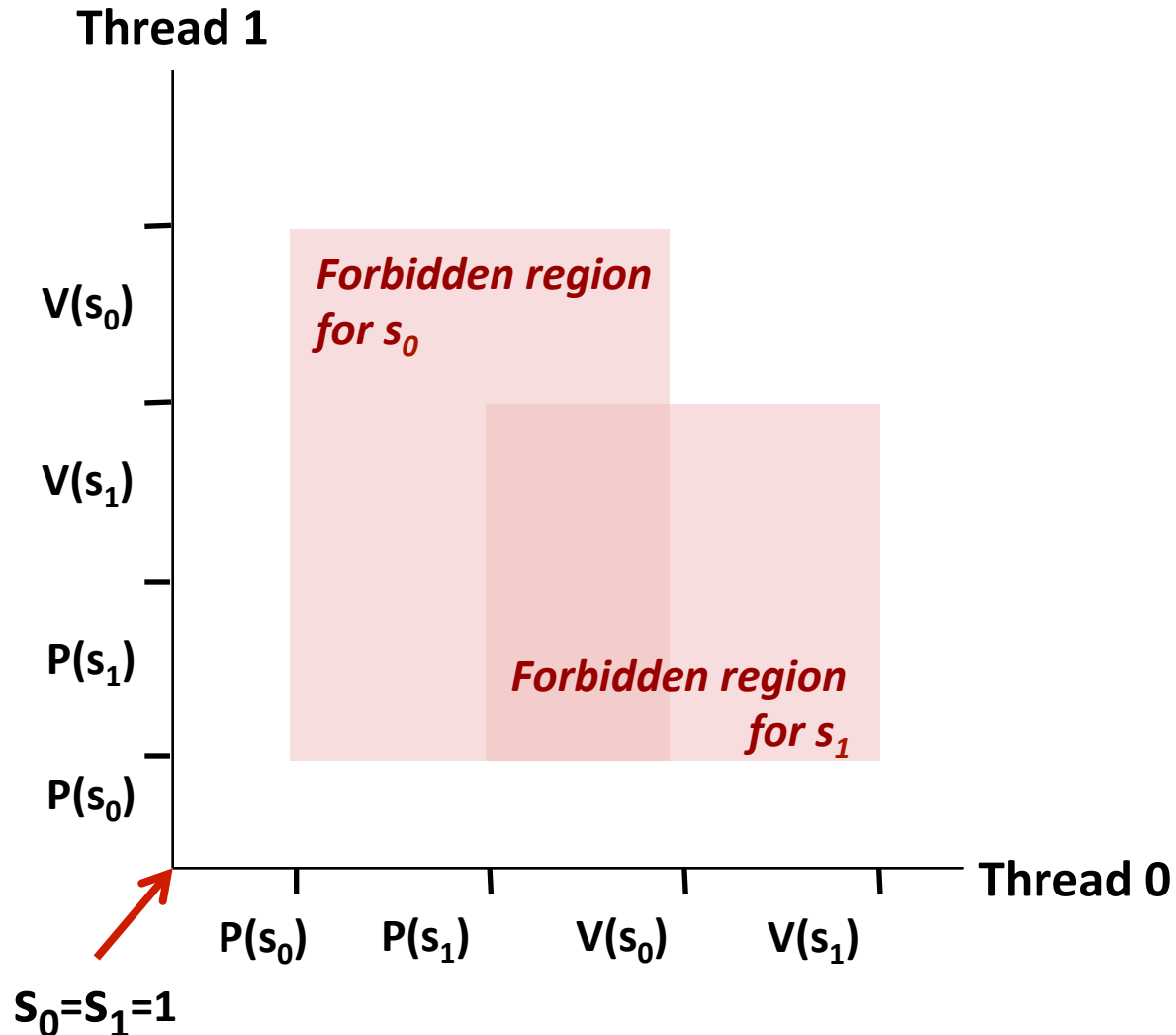

No way for trajectory to get stuck

Processes acquire locks in same order

Order in which locks released immaterial

Demonstration

- See program `deadlock.c`
- 100 threads, each acquiring same two locks
- **Risky mode**
 - Even numbered threads request locks in opposite order of odd-numbered ones
- **Safe mode**
 - All threads acquire locks in same order

Today

- **Using semaphores to schedule shared resources**
 - Producer-consumer problem
 - Readers-writers problem
- **Other concurrency issues**
 - Races
 - Deadlocks
 - **Thread safety**

Crucial concept: Thread Safety

- Functions called from a thread must be *thread-safe*
- *Def:* A function is *thread-safe* iff it will always produce correct results when called repeatedly from multiple concurrent threads.
- **Classes of thread-unsafe functions:**
 - Class 1: Functions that do not protect shared variables
 - Class 2: Functions that keep state across multiple invocations
 - Class 3: Functions that return a pointer to a static variable
 - Class 4: Functions that call thread-unsafe functions

Thread-Unsafe Functions (Class 1)

- **Failing to protect shared variables**
 - Fix: Use *P* and *V* semaphore operations
 - Example: `goodcnt.c`
 - Issue: Synchronization operations will slow down code

Thread-Unsafe Functions (Class 2)

- Relying on persistent state across multiple function invocations
 - Example: Random number generator that relies on static state

```
static unsigned int next = 1;

/* rand: return pseudo-random integer on 0..32767 */
int rand(void)
{
    next = next*1103515245 + 12345;
    return (unsigned int)(next/65536) % 32768;
}

/* srand: set seed for rand() */
void srand(unsigned int seed)
{
    next = seed;
}
```

Thread-Safe Random Number Generator

- Pass state as part of argument
 - and, thereby, eliminate static state

```
/* rand_r - return pseudo-random integer on 0..32767 */  
  
int rand_r(int *nextp)  
{  
    *nextp = *nextp*1103515245 + 12345;  
    return (unsigned int) (*nextp/65536) % 32768;  
}
```

- Consequence: programmer using `rand_r` must maintain seed

Thread-Unsafe Functions (Class 3)

- Returning a pointer to a static variable
- Fix 1. Rewrite function so caller passes address of variable to store result
 - Requires changes in caller and callee
- Fix 2. Lock-and-copy
 - Requires simple changes in caller (and none in callee)
 - However, caller must free memory.

```
/* Convert integer to string */  
char *itoa(int x)  
{  
    static char buf[11];  
    sprintf(buf, "%d", x);  
    return buf;  
}
```

```
char *lc_itoa(int x, char *dest)  
{  
    P(&mutex);  
    strcpy(dest, itoa(x));  
    V(&mutex);  
    return dest;  
}
```

Warning: Some functions like `gethostbyname` require a *deep copy*. Use reentrant `gethostbyname_r` version instead.

Thread-Unsafe Functions (Class 4)

■ Calling thread-unsafe functions

- Calling one thread-unsafe function makes the entire function that calls it thread-unsafe
- Fix: Modify the function so it calls only thread-safe functions 😊

Reentrant Functions

- Def: A function is *reentrant* iff it accesses no shared variables when called by multiple threads.
 - Important subset of thread-safe functions
 - Require no synchronization operations
 - Only way to make a Class 2 function thread-safe is to make it reentrant (e.g., `rand_r`)

All functions

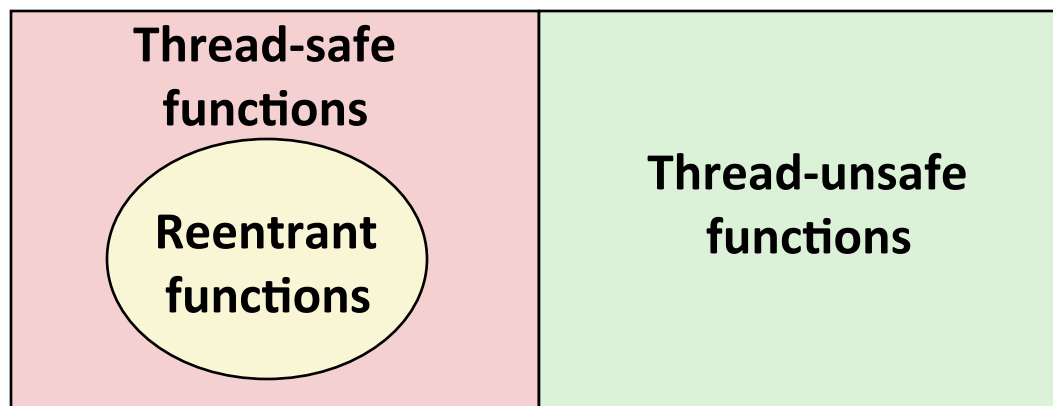

Thread-Safe Library Functions

- All functions in the Standard C Library (at the back of your K&R text) are thread-safe
 - Examples: `malloc`, `free`, `printf`, `scanf`
- Most Unix system calls are thread-safe, with a few exceptions:

Thread-unsafe function	Class	Reentrant version
<code>asctime</code>	3	<code>asctime_r</code>
<code>ctime</code>	3	<code>ctime_r</code>
<code>gethostbyaddr</code>	3	<code>gethostbyaddr_r</code>
<code>gethostbyname</code>	3	<code>gethostbyname_r</code>
<code>inet_ntoa</code>	3	(none)
<code>localtime</code>	3	<code>localtime_r</code>
<code>rand</code>	2	<code>rand_r</code>

Threads Summary

- **Threads provide another mechanism for writing concurrent programs**
- **Threads are growing in popularity**
 - Somewhat cheaper than processes
 - Easy to share data between threads
- **However, the ease of sharing has a cost:**
 - Easy to introduce subtle synchronization errors
 - Tread carefully with threads!
- **For more info:**
 - D. Butenhof, “Programming with Posix Threads”, Addison-Wesley, 1997