

Lecture 29(b)

Compiler Optimizations for Thread-Level Speculation

From the paper: *"Compiler Optimization of Scalar Value Communication Between Speculative Threads"*, by Antonia Zhai, Christopher B. Colohan, J. Gregory Steffan and Todd C. Mowry. ASPLOS, 2002.

Carnegie Mellon

Speculation

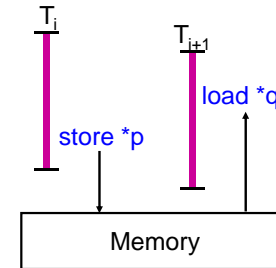

good when $p \neq q$

15-745: Optimizing TLS

2

Carnegie Mellon

Todd C. Mowry

Synchronization (and Forwarding)

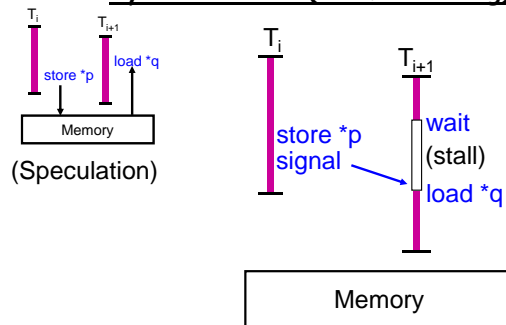

good when $p == q$

15-745: Optimizing TLS

3

Carnegie Mellon

Todd C. Mowry

Synchronizing Scalars

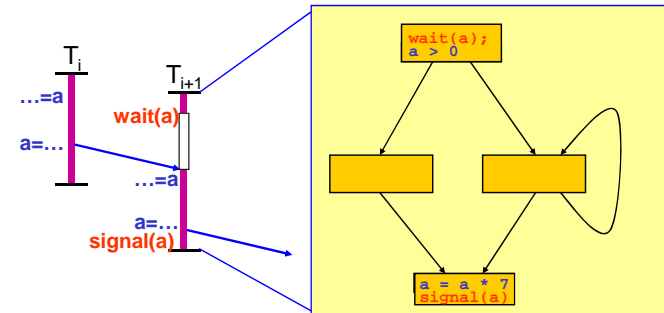

15-745: Optimizing TLS

4

Carnegie Mellon

Todd C. Mowry

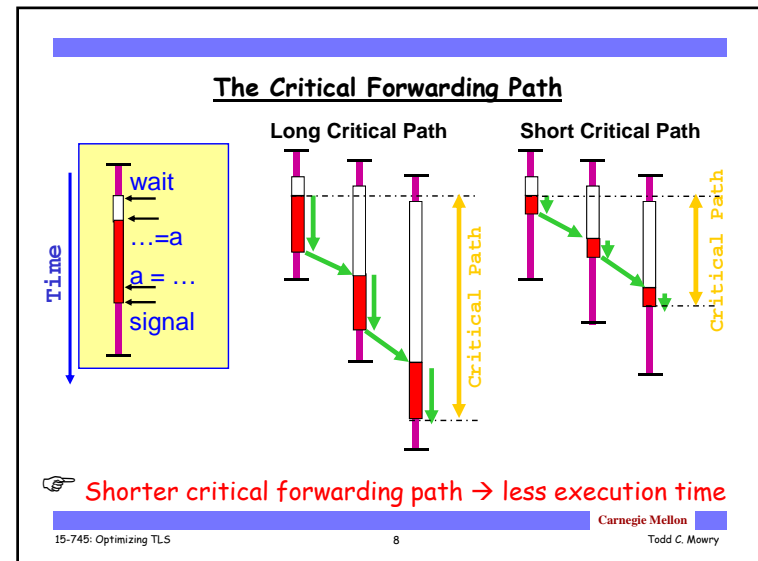
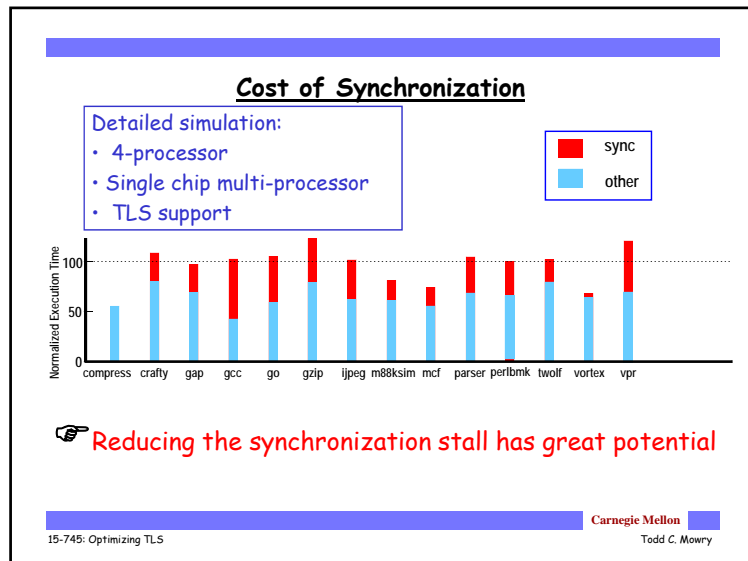
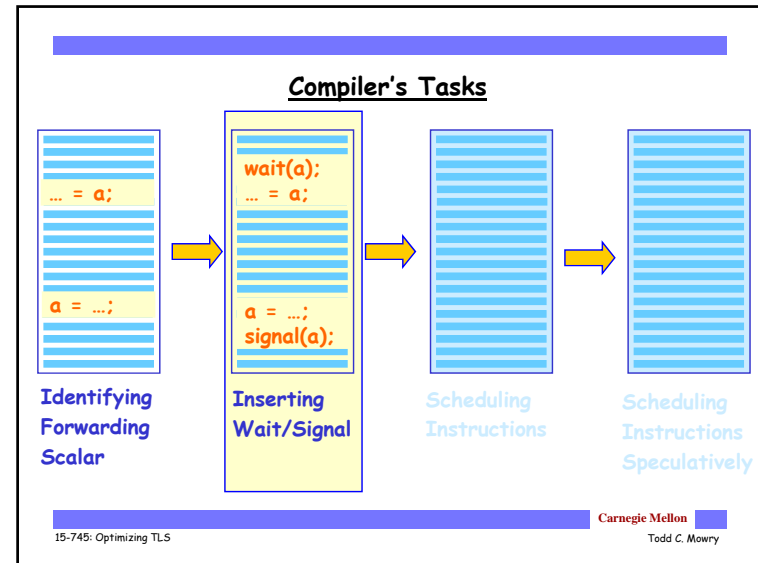
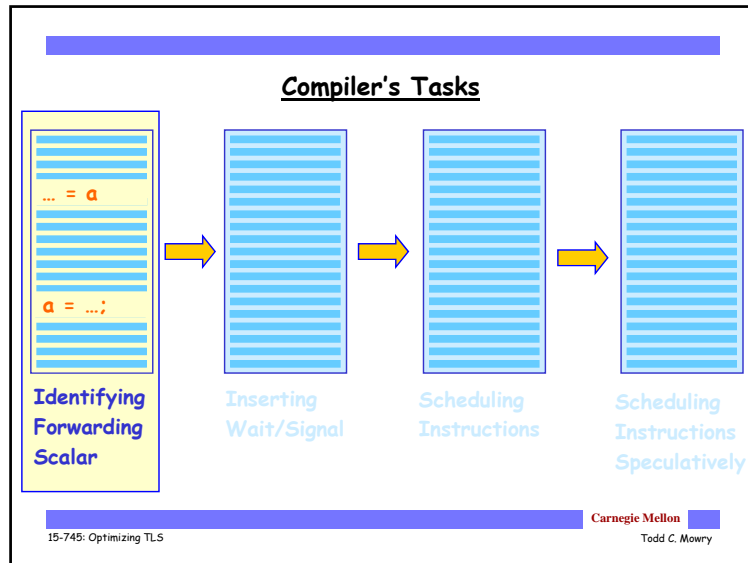

Reducing the Critical Forwarding Path

Instruction scheduling can reduce critical forwarding path

15-745: Optimizing TLS Carnegie Mellon
 9 Todd C. Mowry

Compiler's Tasks

15-745: Optimizing TLS Carnegie Mellon
 Todd C. Mowry

Related Work and Contribution

Related work:

- Multiscalar instruction scheduling [Vijaykumar, Thesis '98]
 - Moving instructions backward one basic block at a time
 - Evaluated under the context of Multiscalar

Our contributions:

- A robust instruction scheduling algorithm
 - Deals with larger threads
 - Handles complex control flow
- Control and data dependence speculation
 - Extends our algorithm to accommodate speculative scheduling
 - Evaluates with detailed simulation
- Comparison with hardware techniques that reduce critical path

15-745: Optimizing TLS Carnegie Mellon
 11 Todd C. Mowry

Scheduling Instructions

Dataflow analysis
 Handles complex control flow

Define two dataflow analyses

- Stack**
 Find the instructions to compute the forwarded value?
- Earliest**
 Find the earliest node to compute the forwarded value?

15-745: Optimizing TLS Carnegie Mellon
 Todd C. Mowry

Computation Stack

☞ Stores the instructions to compute a forwarded value

Associating a stack with every node for every forwarded scalar

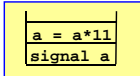

We know how to compute the forwarded value

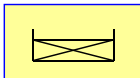

We don't know how to compute the forwarded value

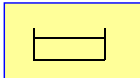

We have not evaluated this node

A Simplified Example from GCC

```

do {
  ...
} while(p);
  
```

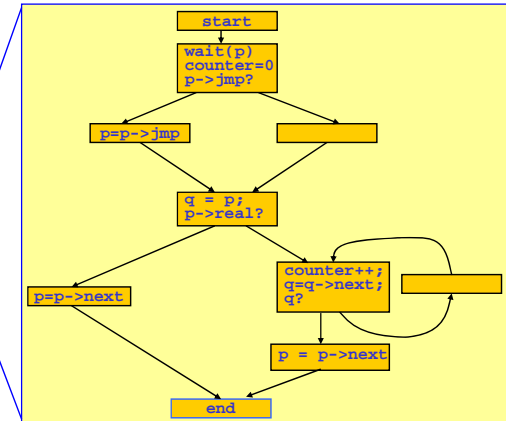

Stack Analysis

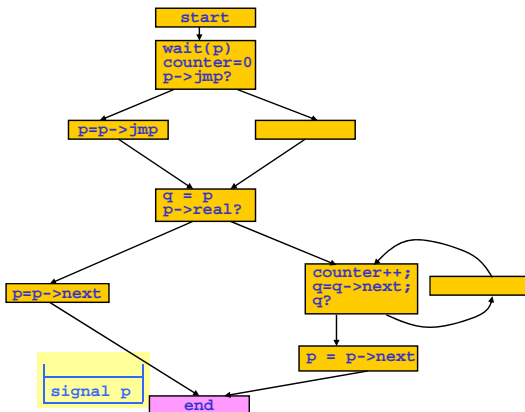

Stack Analysis

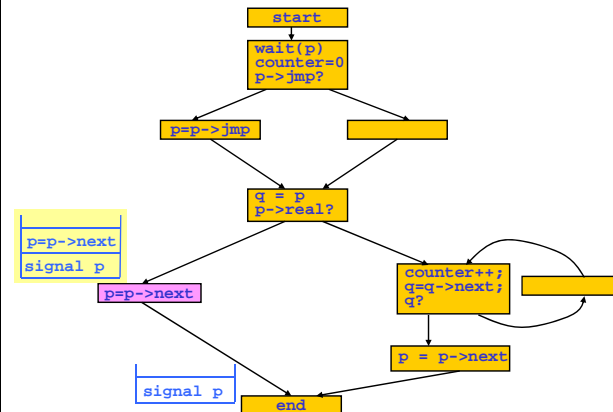

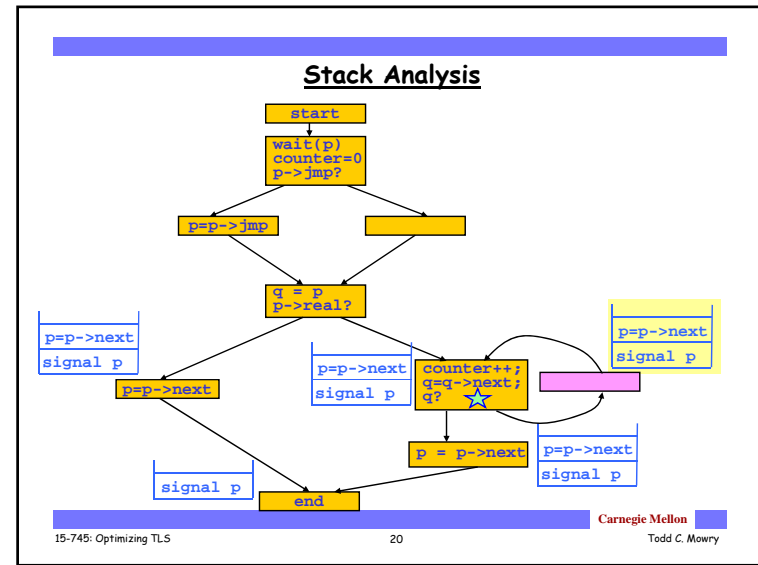
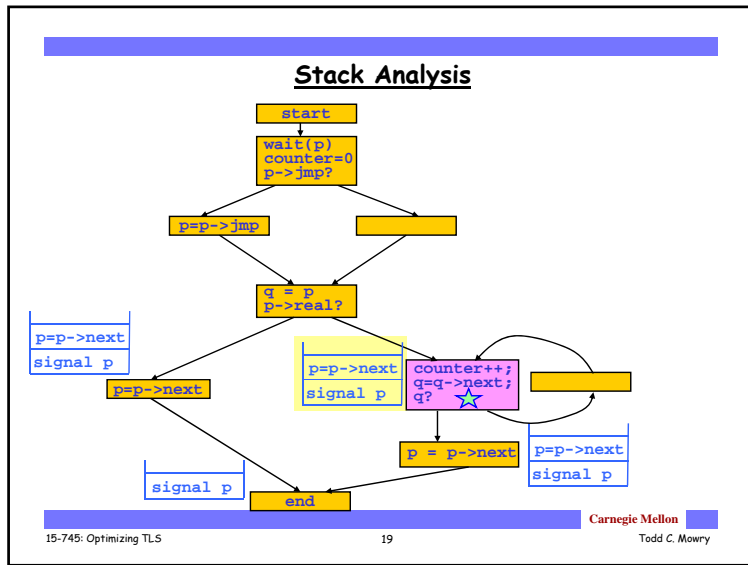
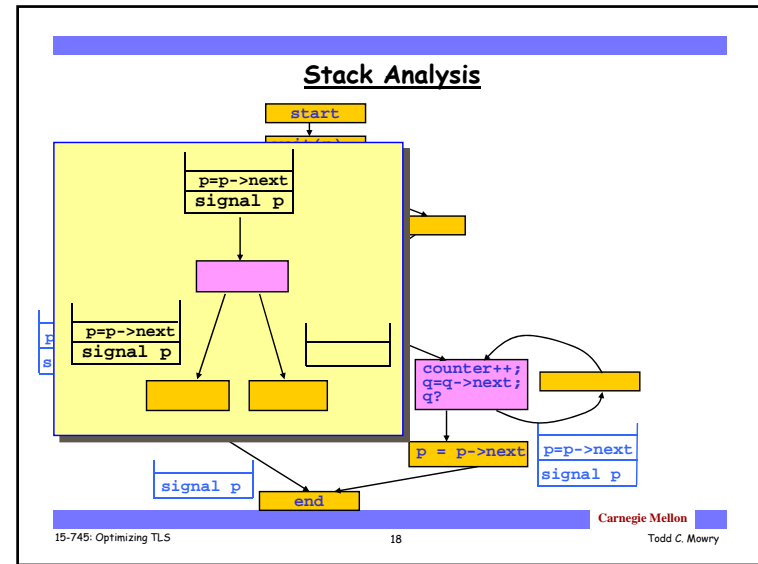
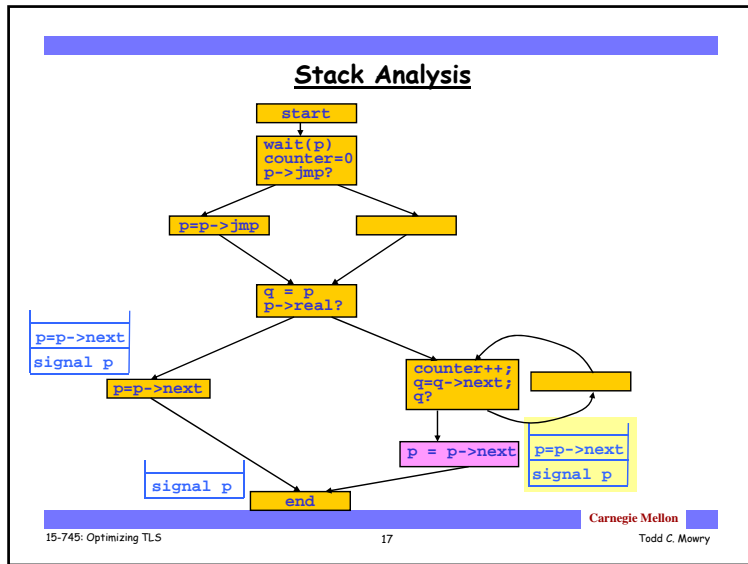

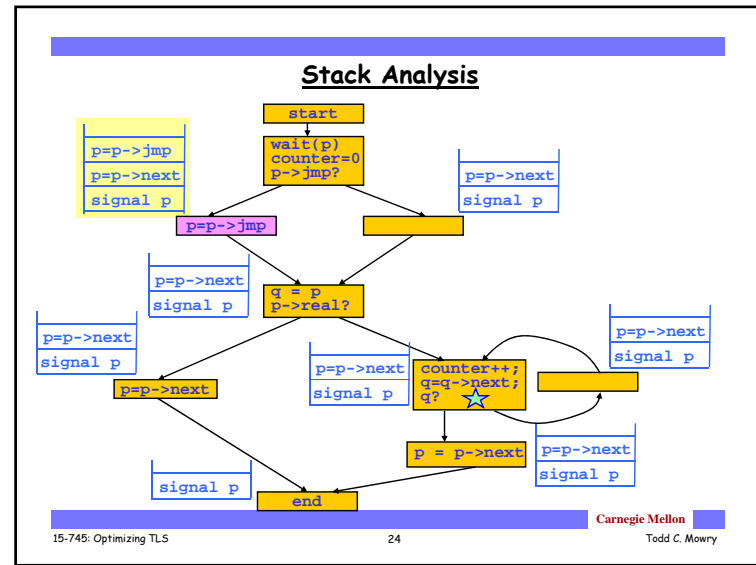
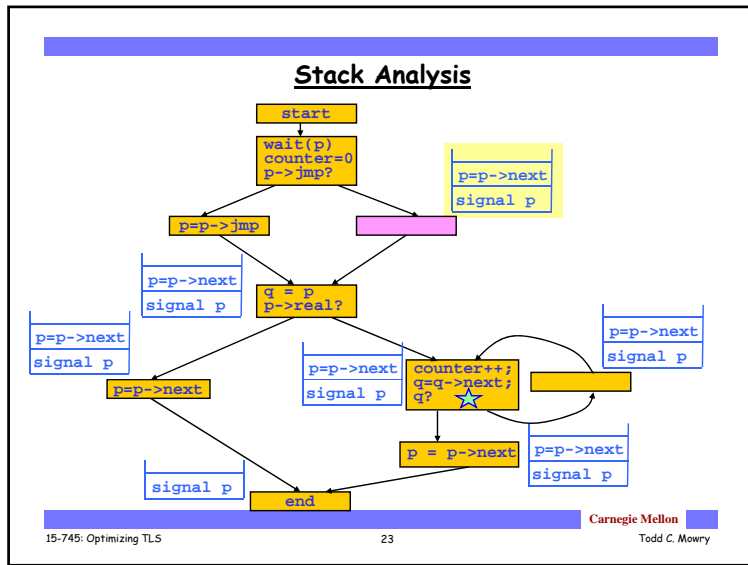
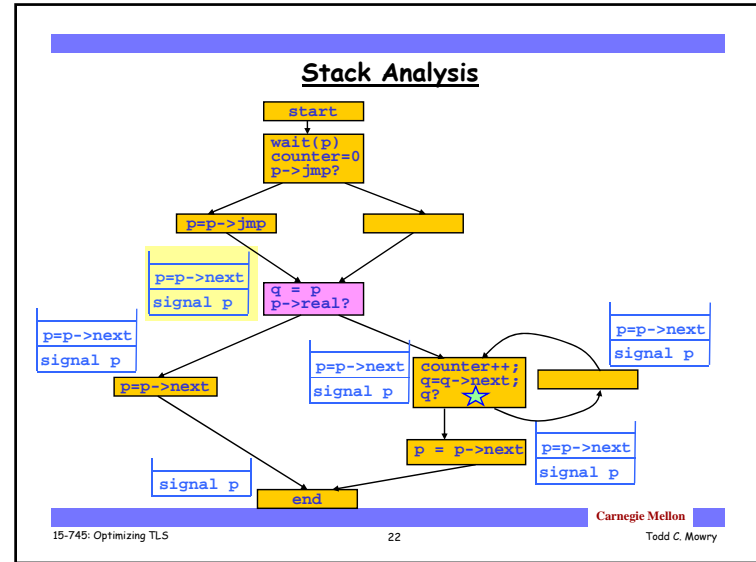
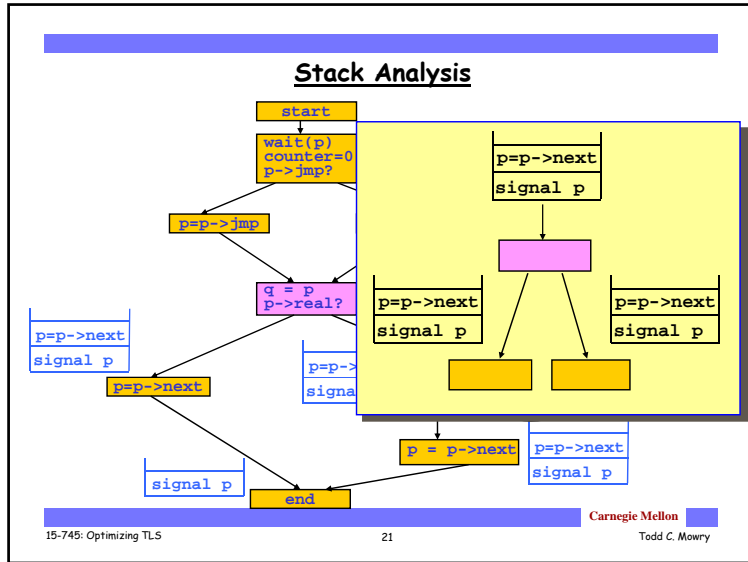

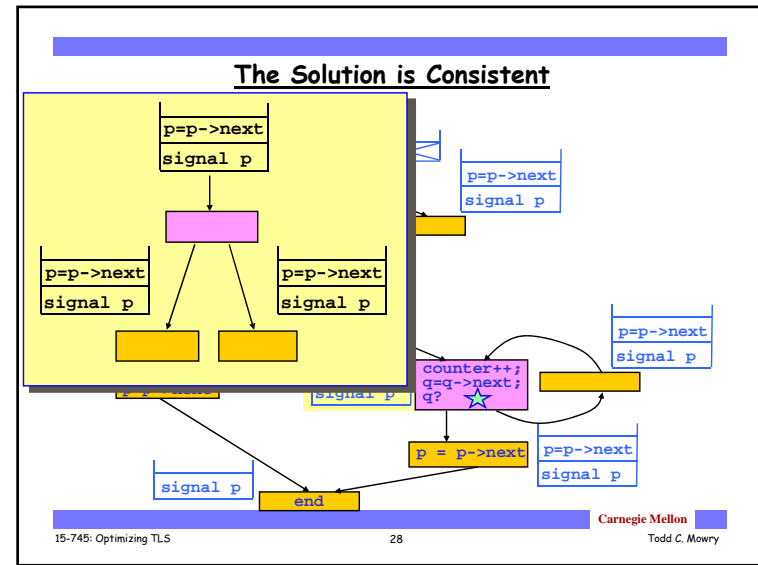
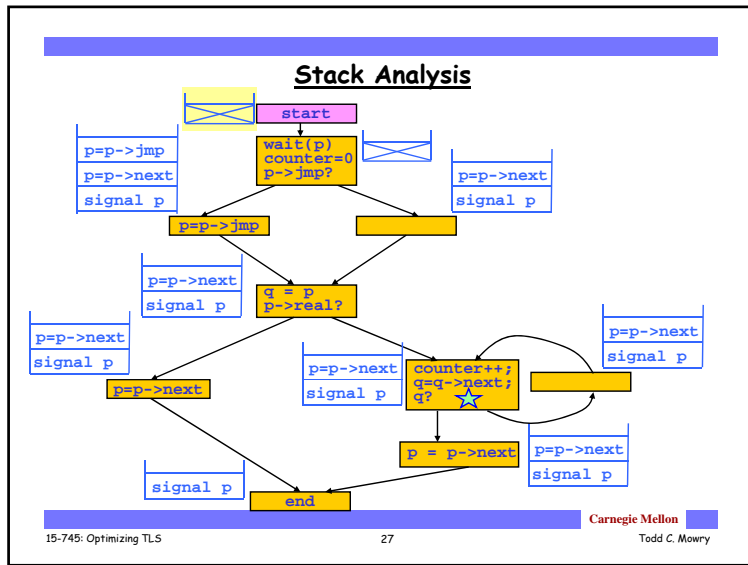
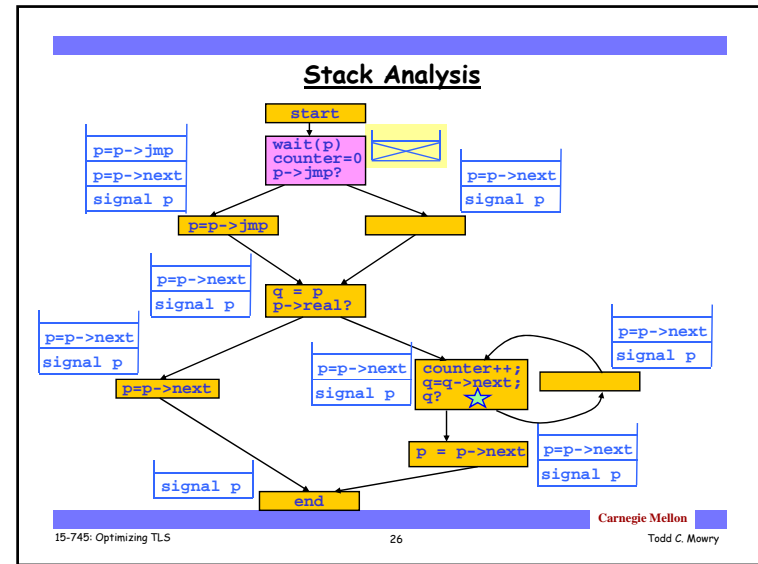
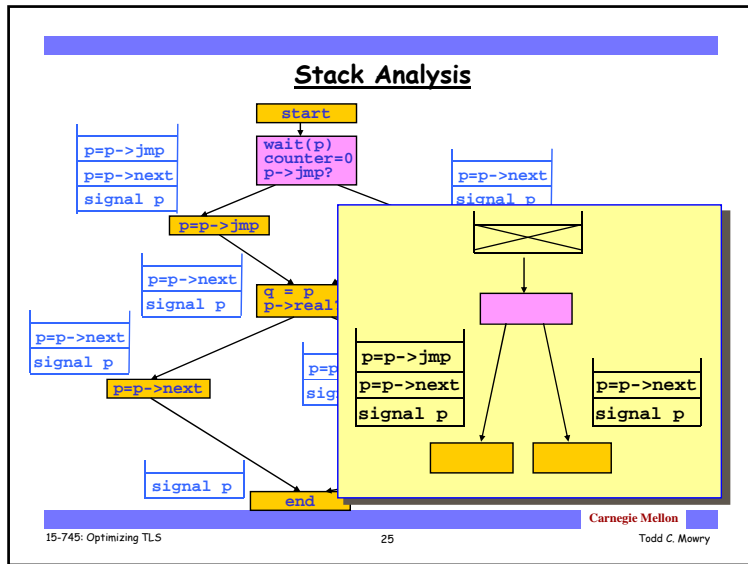

Scheduling Instructions

Dataflow analysis

Handles complex control flow

Define two dataflow analyses

Stack

Find the instructions to compute the forwarded value?



Earliest

Find the earliest node to compute the forwarded value?

The Earliest Analysis

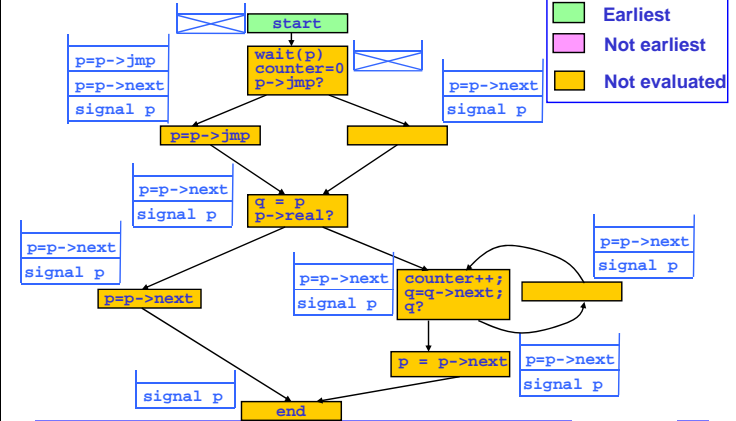

The Earliest Analysis

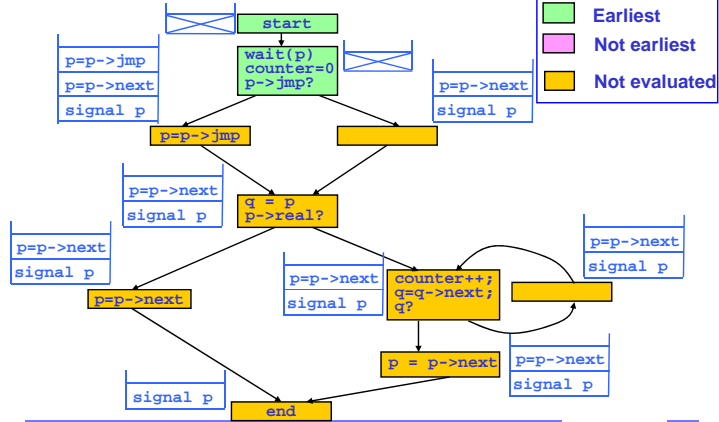

The Earliest Analysis

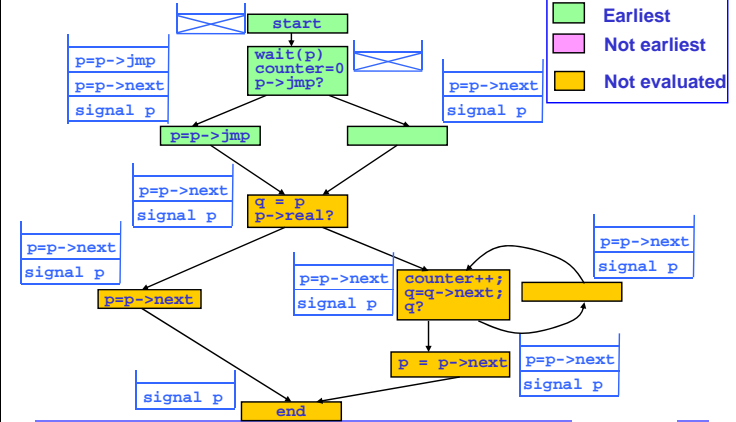

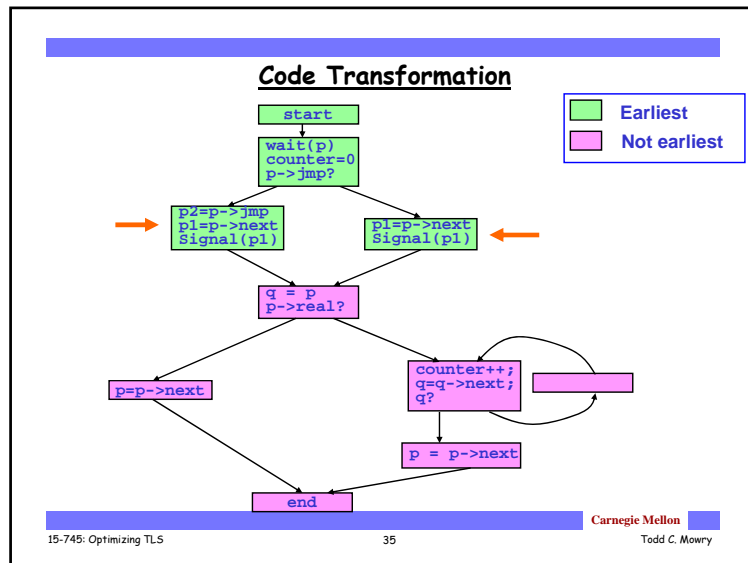
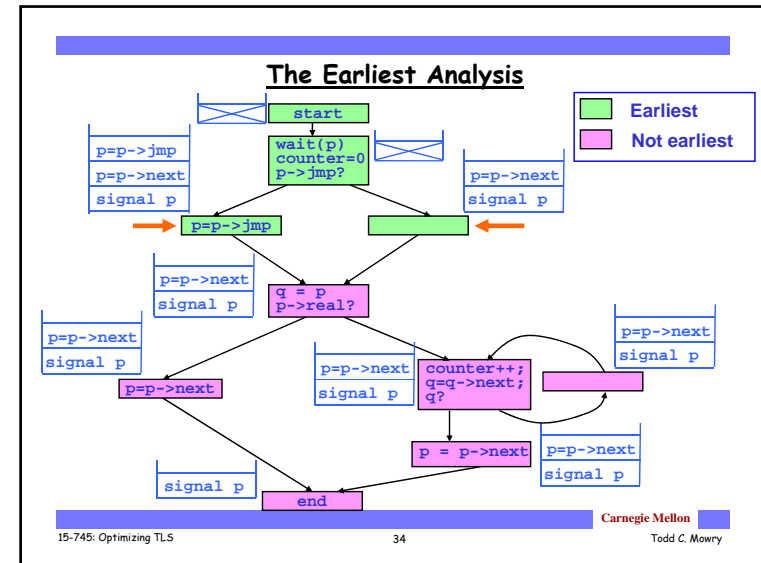
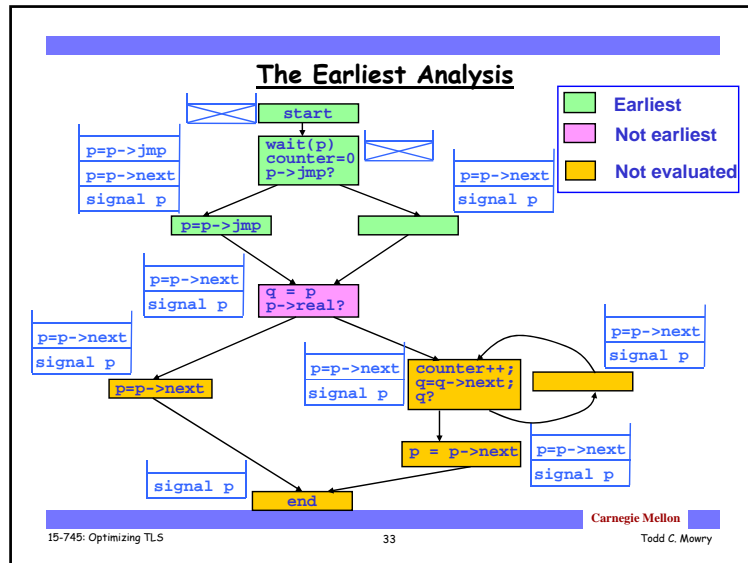

Experimental Framework

Benchmarks

- from SPECint95 and SPECint2000, -O3 optimization

Underlying architecture

- 4-processor, single-chip multiprocessor
- speculation supported by coherence

Simulator

- superscalar, similar to MIPS R10K
- models all bandwidth and contention

detailed simulation!

15-745: Optimizing TLS 36 Carnegie Mellon Todd C. Mowry

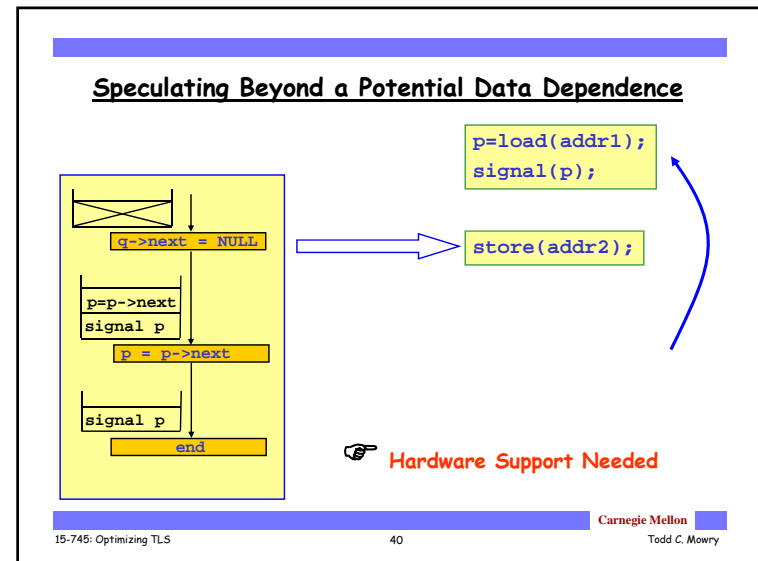
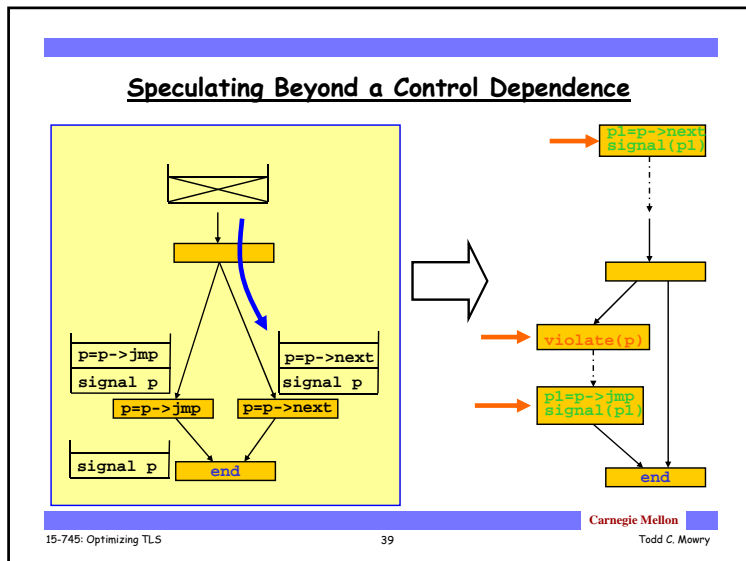
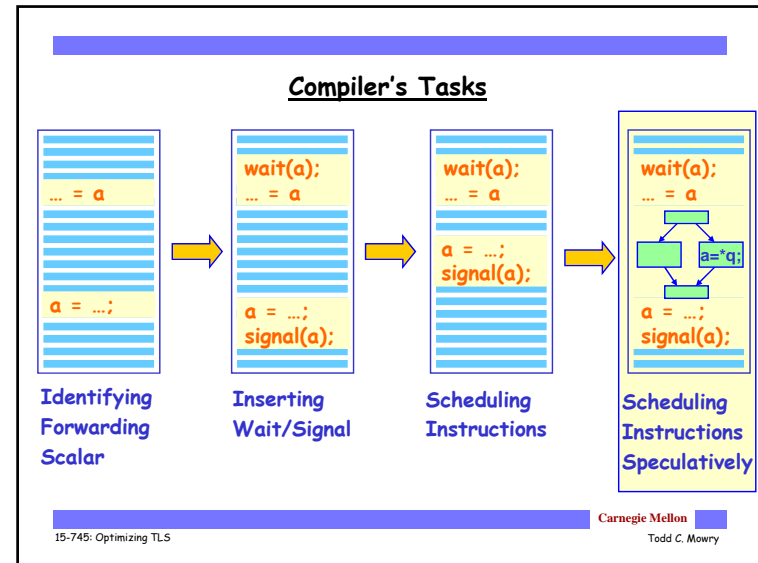
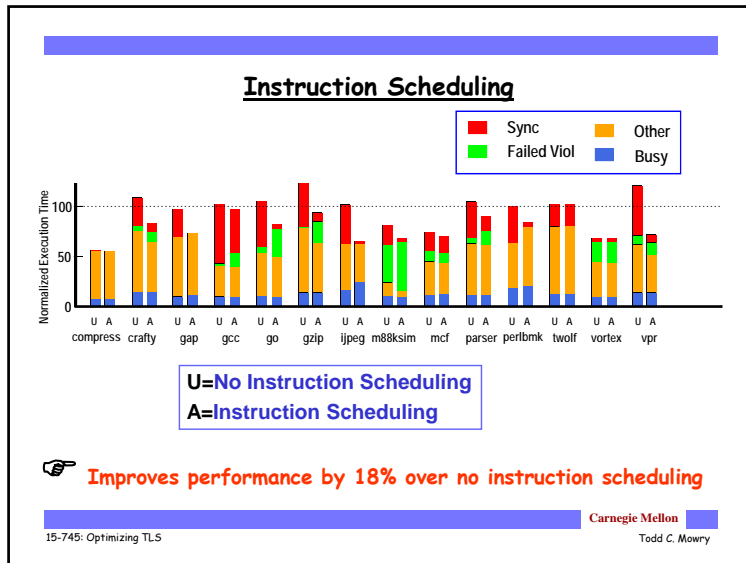

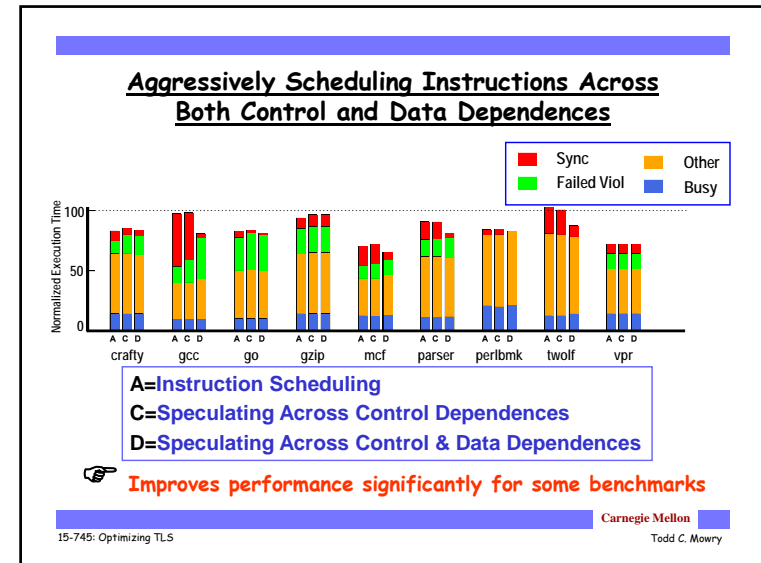
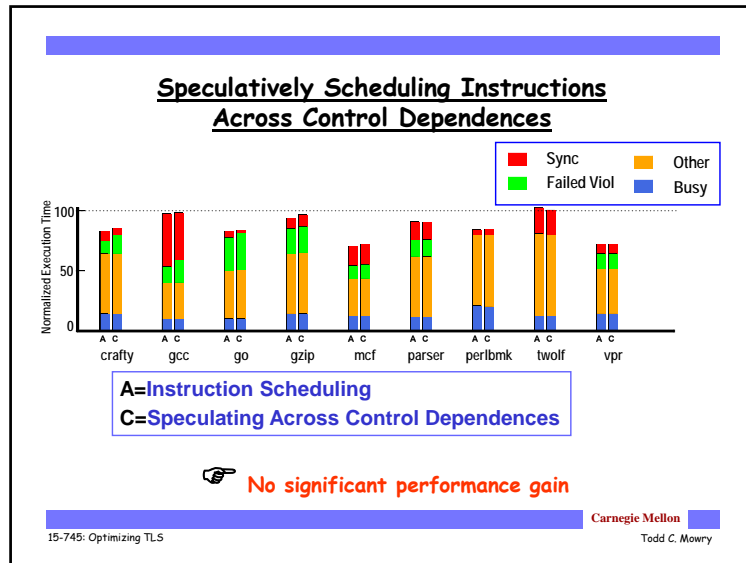

- ### Hardware Optimization to Reduce Synchronization
- Hardware optimization techniques [Steffan et al, HPCA'02]
- Avoid synchronization:
 - use the value from a hardware value predictor
 - Reduce synchronization stalls:
 - prioritize computation of forwarded value
- Hardware optimization impact [Steffan et al, HPCA'02]
- No compiler optimization: **Effective**
 - With compiler optimization: **Negligible**
- Carnegie Mellon
Todd C. Mowry
- 15-745: Optimizing TLS 43

- ### Conclusions
- #### Instruction scheduling for reducing synchronization
- Is effective in reducing critical forwarding path
 - Performance improved by 18%
 - Is beneficial to handle complex control flow, such as inner loops
 - Improved GCC by 3%
 - Gives additional benefit with speculative instruction scheduling
 - Our robust instruction scheduling algorithm can be easily extended to accommodate this
 - One biggest benefactor is GCC, performance improved by 18%
 - Reduces the importance of additional hardware optimization
- 👉 **Critical forwarding path can be addressed by the compiler**
- Carnegie Mellon
Todd C. Mowry
- 15-745: Optimizing TLS 44